



Safety glasses should be worn at all times while installing this product.

YEARS: 2011-CURRENT

MAKE: CHRYSLER & DODGE

MODEL: 200, 200 HARD TOP CONVERTIBLE & AVENGER

STYLE: SEDAN

WARNING: NEVER EXCEED YOUR VEHICLE MANUFACTURER'S RECOMMENDED TOWING CAPACITY





WEIGHT CARRYING:
 TRAILER WEIGHT: 2,000 LBS.
 TONGUE WEIGHT: 200 LBS.

WARNING:
 WE RECOMMEND THE USE OF 18050 STABILIZING STRAPS FOR ALL NON-TRAILER (WHEEL-LESS) LOADS. PLEASE SEE THE CURT CATALOG OR VISIT US ONLINE AT WWW.CURTMFG.COM FOR FURTHER INFORMATION.

INSTALLATION TIME: 20 MIN.

THE INSTALL TIME LISTED IS FOR PROFESSIONAL INSTALLERS. IF YOU ARE HESITANT TO UNDERTAKE THIS TASK ON YOUR OWN, CONTACT AN AUTHORIZED CURT INSTALLER FOR ADDITIONAL ASSISTANCE.



INSTALLATION REQUIRES:

 RATCHET	 SOCKET 3/4"	 BOXED END WRENCH 3/4"
 TORQUE WRENCH	 PRY BAR	

INSTALLATION TIPS:

- BEFORE YOU BEGIN INSTALLATION, READ ALL INSTRUCTIONS THOROUGHLY.
- TO EASE INSTALLATION, 2 PEOPLE MAY BE REQUIRED.
- USING PROPER TOOLS WILL GREATLY IMPROVE THE QUALITY OF THE INSTALL AND REDUCE THE TIME REQUIRED.
- NEED HELP OR HAVE SOME QUESTIONS? CALL TECHNICAL SUPPORT AT 877.287.8634

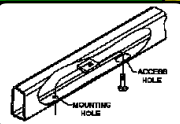
LEVEL OF DIFFICULTY: EASY

EASY	MODERATE	HARD
	FISHWIRE HARDWARE	
	NO DRILLING REQUIRED	
	VEHICLES WITH DUAL EXHAUST LOWER EXHAUST	

VEHICLE PHOTO:

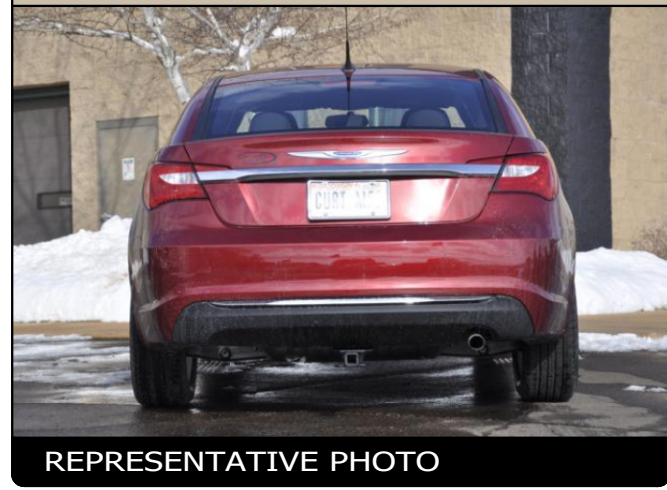

REPRESENTATIVE PHOTO

HITCH ILLUSTRATION:

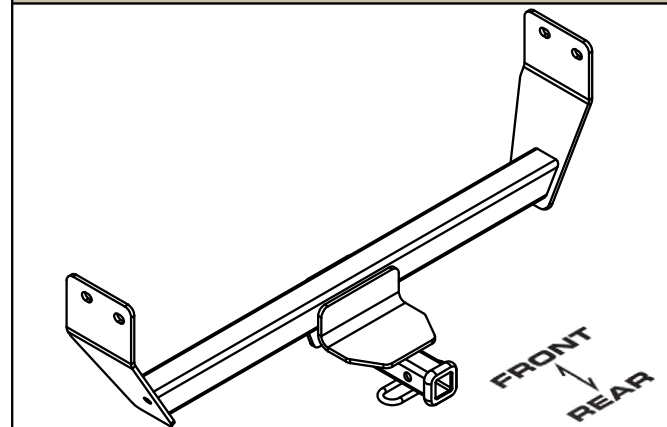

MAKE SURE YOUR HITCH MATCHES

PERIODICALLY CHECK THIS RECEIVER HITCH TO ENSURE ALL FASTENERS ARE TIGHT AND ALL STRUCTURAL COMPONENTS ARE SOUND

CURT Manufacturing Inc. warrants this product to be free of defects in material and/or workmanship at the time of retail purchase by the original purchaser. If the product is found to be defective, Curt Manufacturing Inc. may repair or replace the product at their option, when the product is returned, prepaid, with proof of purchase. Alteration to, misuse of, or improper installation of this product voids the warranty. Curt Manufacturing Inc.'s liability is limited to repair or replacement of products found to be defective, and specifically excludes liability for incidental or consequential loss or damage.

For more information log onto www.curtmfg.com, & for helpful towing tips log onto www.hitchinfo.com

INSTALLATION WALKTHROUGH:

Parts List			
ITEM	QTY	PART NUMBER	DESCRIPTION
1	2	10-10413	HHCS, 1/2-13 UNC, 4-1/2, GRD8, YZ
2	2	CM-SP34	.188 x 1.50 x 3.00" ROUND HOLE SPACER
3	2	10-10272	BOLT, CAR, 1/2-13 UNC, 1-3/4, GRD8, YZ
4	2	CM-SP12	.250 x 1.00 x 2.00" SQUARE HOLE SPACER
5	4	20-00062	NUT, SER-FLANGE, 1/2-13 UNC, GRD8, YZ
6	2	1_2 FISHWIRE	1/2" FISHWIRE

FISHWIRE TECHNIQUE

INSERT COILED END OF FISHWIRE TOOL THROUGH HITCH MOUNTING HOLE IN VEHICLE FRAME RAIL AND OUT THE ACCESS HOLE. PASS COILED END OF FISHWIRE THROUGH SPACER AND THREAD BOLT INTO COIL. KINK WIRE TO KEEP SPACER SEPARATE FROM BOLT AS SHOWN. PULL FISHWIRE, SPACER, AND BOLT THROUGH FRAME AND OUT MOUNTING HOLE. USE FISHWIRE TO GUIDE HITCH DURING MOUNTING AND PREVENT LOSS OF BOLT / SPACER INSIDE FRAME RAIL.

NOTE: SOME VEHICLES MAY FISHWIRE THROUGH END OF FRAME

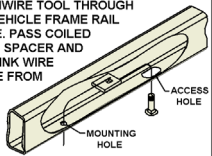

ACCESS HOLE (BOTH SIDES)

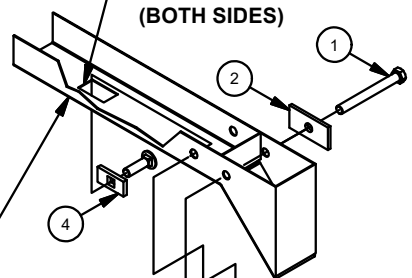

PASSENGER SIDE FRAME RAIL

DRIVER SIDE FRAME RAIL

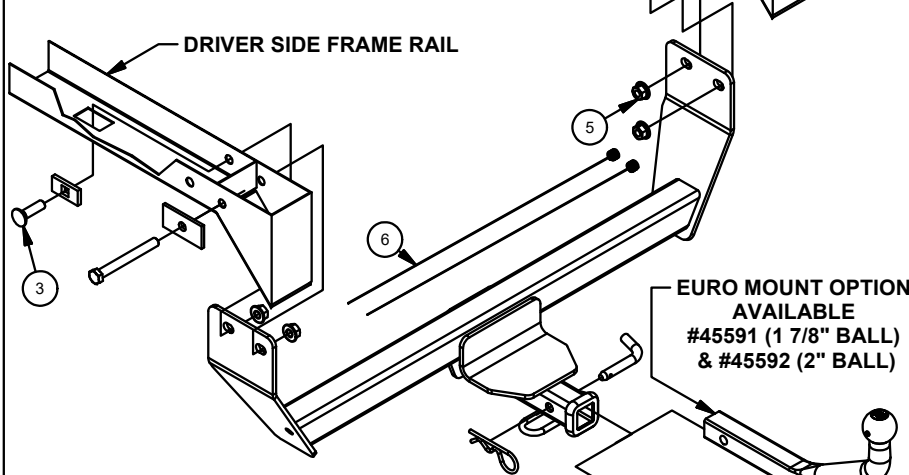

EURO MOUNT OPTION AVAILABLE
#45591 (1 7/8" BALL)
& #45592 (2" BALL)

DESIGNED FOR USE WITH BALLMOUNT #45522

FRONT
↓
REAR

1. For vehicles with dual exhaust, lower exhaust by removing the (4) rear most rubber isolators (See RUBBER ISOLATOR REMOVAL DIAGRAM). Wire may be used to hold exhaust to prevent damage if lowered to far.

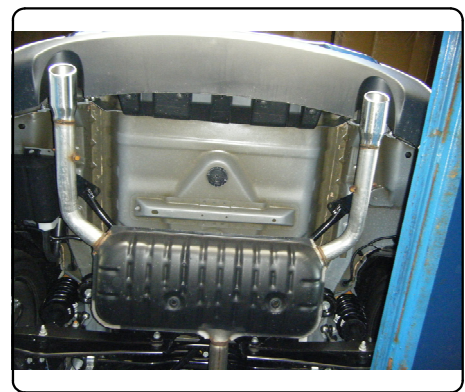

RUBBER ISOLATOR REMOVAL DIAGRAM

This technique can be used if an Exhaust Hanger Removal Pliers is not available.

Using a 5/8" open end wrench, slide the wrench up to the rubber isolator, cradling the hanger rod as shown. Next place the flat edge of a pry bar between the wrench and the hanger stop or hanger rod. Then simply rotate the pry bar toward the wrench to remove the rubber isolator.

Note: Using a spray lubricant or soapy water on the hanger rod and the rubber isolator helps removal.

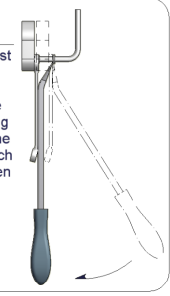

2. Fishwire 1/2" carriage bolt and CM-SP12 spacer into position through access hole in each frame rail. See FISHWIRE TECHNIQUE above. **Note:** Leave fishwires attached to hardware to prevent loss in frame.

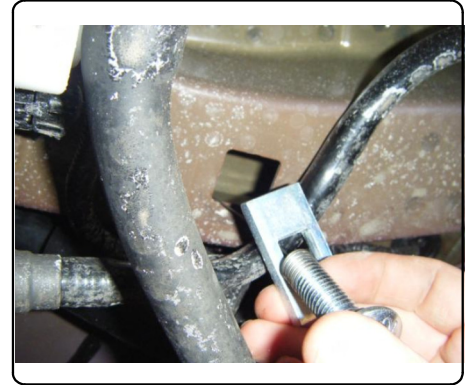

INSTALLATION WALKTHROUGH:

3. Place 1/2" hex bolts with CM-SP34 spacers into rear mounting holes in frame rails.

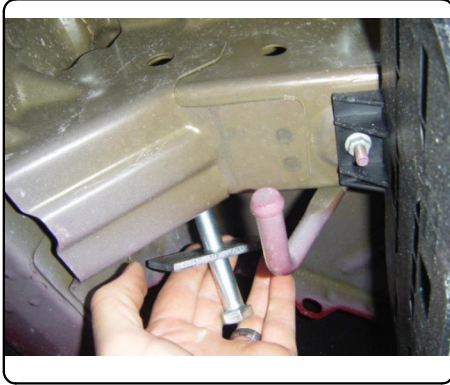

4. Thread fishwires through appropriate mounting holes and raise hitch into position.



5. Secure hitch to vehicle with (4) 1/2" flange nuts.



6. Torque all 1/2" hardware to 110 ft-lbs.
Install is complete.

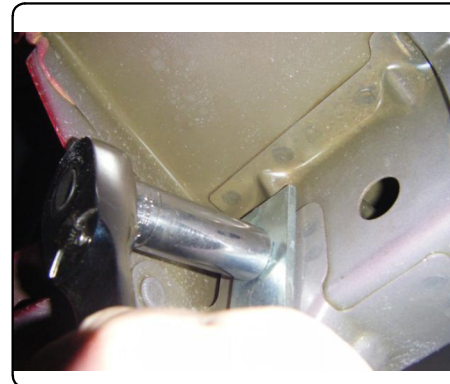

11133

CHRYSLER 200, 200 HARD TOP CONVERTIBLE & DODGE AVENGER

9/9/2020

GROSS LOAD CAPACITY WHEN USED AS A WEIGHT CARRYING HITCH: 2,000 LBS. TRAILER WEIGHT & 200 LBS. TONGUE WEIGHT.

DO NOT EXCEED VEHICLE MANUFACTURER'S RECOMMENDED TOWING CAPACITY.

WARNING: ALL NON-TRAILER LOADS APPLIED TO THIS PRODUCT MUST BE SUPPORTED BY 18050 STABILIZING STRAPS.

** FAILURE TO PROPERLY SUPPORT NON-TRAILER LOADS WILL VOID PRODUCT WARRANTY**

HAVING INSTALLATION QUESTIONS? CALL TECHNICAL SUPPORT AT 1-877-287-8634

Parts List

ITEM	QTY	PART NUMBER	DESCRIPTION
1	2	10-10413	HHCS, 1/2-13 UNC, 4-1/2, GRD8, YZ
2	2	CM-SP34	.188 x 1.50 x 3.00" ROUND HOLE SPACER
3	2	10-10272	BOLT, CAR, 1/2-13 UNC, 1-3/4, GRD8, YZ
4	2	CM-SP12	.250 x 1.00 x 2.00" SQUARE HOLE SPACER
5	4	20-00062	NUT, SER-FLANGE, 1/2-13 UNC, GRD8, YZ
6	2	1_2 FISHWIRE	1/2" FISHWIRE

FISHWIRE TECHNIQUE

INSERT COILED END OF FISHWIRE TOOL THROUGH HITCH MOUNTING HOLE IN VEHICLE FRAME RAIL AND OUT THE ACCESS HOLE. PASS COILED END OF FISHWIRE THROUGH SPACER AND THREAD BOLT INTO COIL. KINK WIRE TO KEEP SPACER SEPERATE FROM BOLT AS SHOWN. PULL FISHWIRE, SPACER, AND BOLT THROUGH FRAME AND OUT MOUNTING HOLE. USE FISHWIRE TO GUIDE HITCH DURING MOUNTING AND PREVENT LOSS OF BOLT / SPACER INSIDE FRAME RAIL.

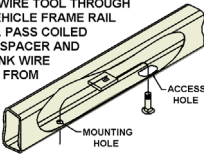

NOTE: SOME VEHICLES MAY FISHWIRE THROUGH END OF FRAME

RUBBER ISOLATOR REMOVAL DIAGRAM

This technique can be used if and Exhaust Hanger Removal Pliers is not available.

Using a 5/8" open end wrench, slide the wrench up to the rubber isolator, cradling the hanger rod as shown. Next place the flat edge of a pry bar between the wrench and the hanger stop or hanger rod. Then simply rotate the pry bar toward the wrench to remove the rubber isolator.

Note: Using a spray lubricant or soapy water on the hanger rod and the rubber isolator helps removal.

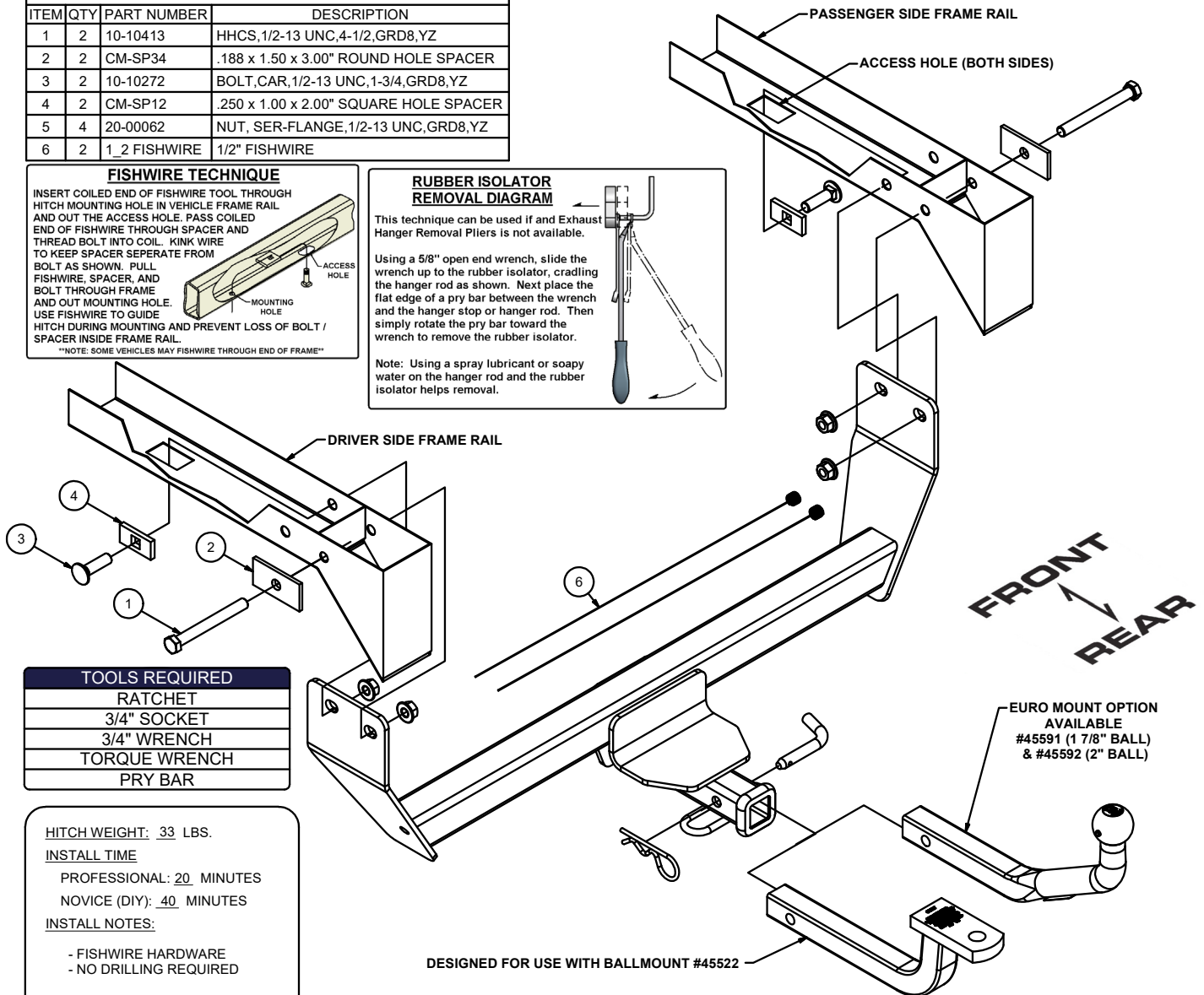
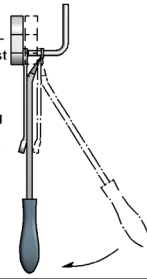

TOOLS REQUIRED

RATCHET
3/4" SOCKET
3/4" WRENCH
TORQUE WRENCH
PRY BAR

HITCH WEIGHT: 33 LBS.

INSTALL TIME

PROFESSIONAL: 20 MINUTES

NOVICE (DIY): 40 MINUTES

INSTALL NOTES:

- FISHWIRE HARDWARE
- NO DRILLING REQUIRED

DESIGNED FOR USE WITH BALLMOUNT #45522

INSTALLATION STEPS

1. For vehicles with dual exhaust, lower exhaust by removing the (4) rear most rubber isolators (See RUBBER ISOLATOR REMOVAL DIAGRAM). Wire may be used to hold exhaust to prevent damage if lowered to far.
2. Fishwire 1/2" carriage bolt and CM-SP12 spacer into position through access hole in each frame rail. See FISHWIRE TECHNIQUE above. **Note:** Leave fishwires attached to hardware to prevent loss in frame.
3. Place 1/2" hex bolts with CM-SP34 spacers into rear mounting holes in frame rails.
4. Thread fishwires through appropriate mounting holes and raise hitch into position.
5. Secure hitch to vehicle with (4) 1/2" flange nuts.
6. Torque all 1/2" hardware to 110 ft-lbs.

PERIODICALLY CHECK THIS RECEIVER HITCH TO ENSURE THAT ALL FASTENERS ARE TIGHT AND THAT ALL STRUCTURAL COMPONENTS ARE SOUND.

Curt Manufacturing Inc., warrants this product to be free of defects in material and/or workmanship at the time of retail purchase by the original purchaser. If the product is found to be defective, Curt Manufacturing Inc., may repair or replace the product, at their option, when the product is returned, prepaid, with proof of purchase. Alteration to, misuse of, or improper installation of this product voids the warranty. Curt Manufacturing Inc.'s liability is limited to repair or replacement of products found to be defective, and specifically excludes liability for incidental or consequential loss or damage.