

1501-0722, 1501-0722B

# 4" OVAL BAR CURVED

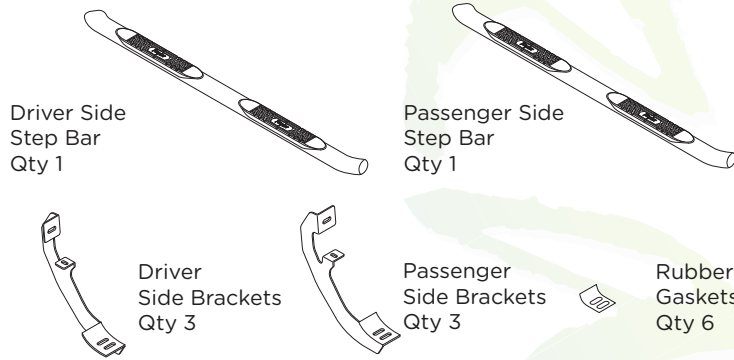

### Components:



### Hardware:

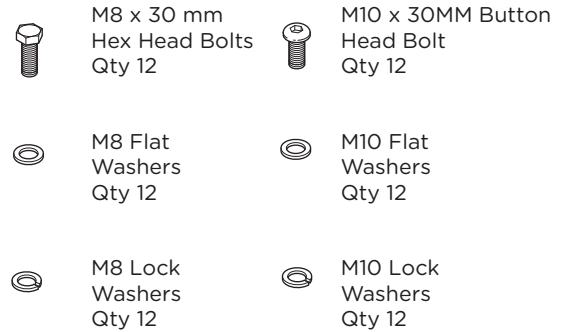

### Tools Required:

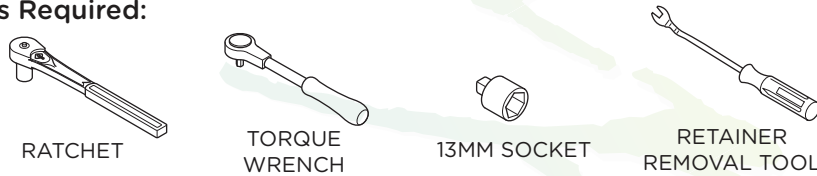

### Torque Specifications:

For Rocker Panel Mount Installations  
M8 through M12 bolts and nuts are set to 15-20 ft lbs.

**Note: When installing the brackets and bars, all hardware must be left loose until all the items are attached.**

1. Remove all contents from the package and check steps for any damage. Also, verify that all components and hardware listed above are included before you begin installation.
2. Read installation manual and installation drawing completely. Understand all brackets and bolts before installation.
3. Existing mounting holes are located on the interior wall of the rocker panel. These mounting holes will be used per the following instruction.

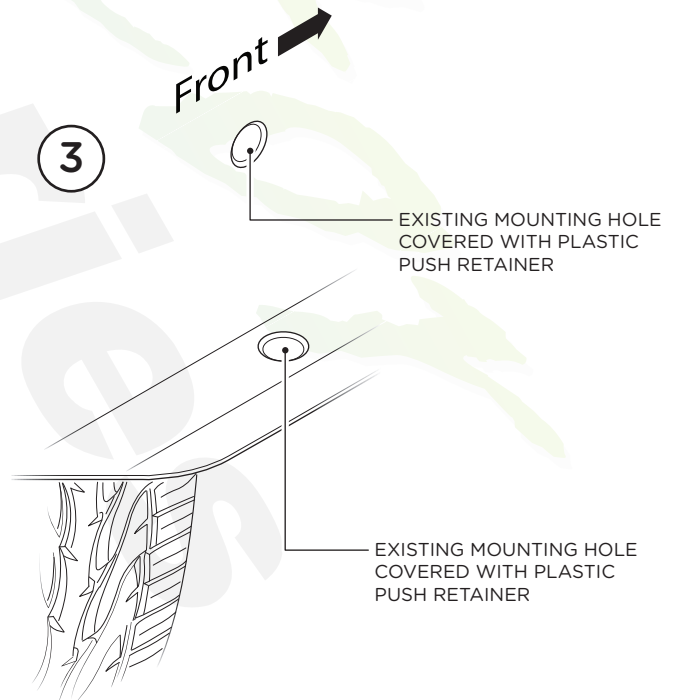

4. On driver side of vehicle, align Front, Center and Rear Brackets as shown.

5. Driver side bracket cradles face to the front of the truck.

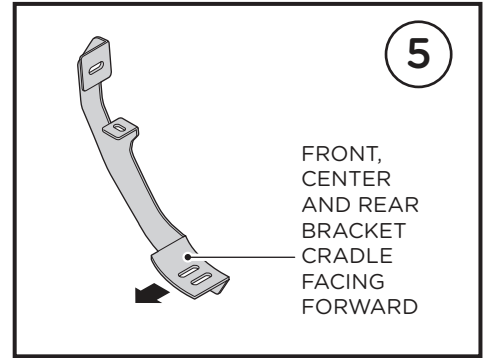
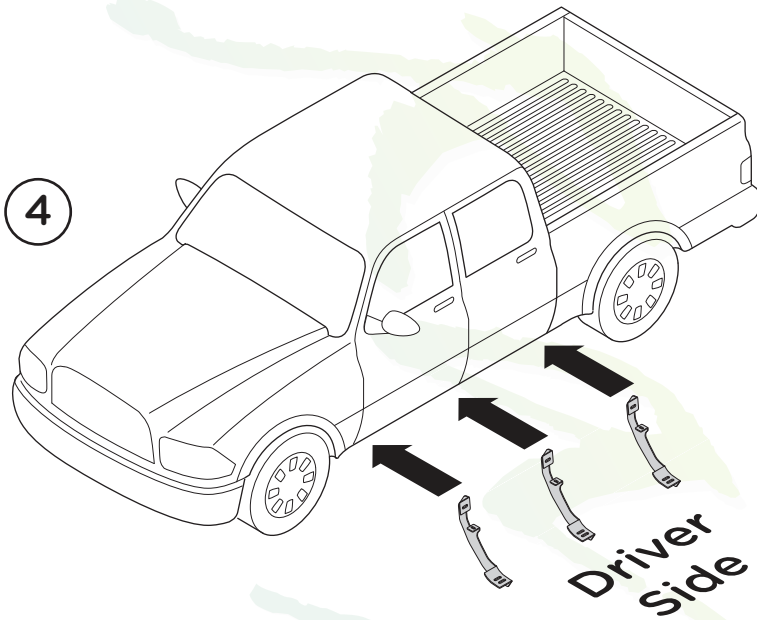

6. Starting from the front of the cab, locate the first, second and fourth set of plastic push retainers on the rocker panel. Remove the retainers using a Retainer Removal Tool. This will expose threaded inserts on the rocker panel used for mounting the brackets to the vehicle.

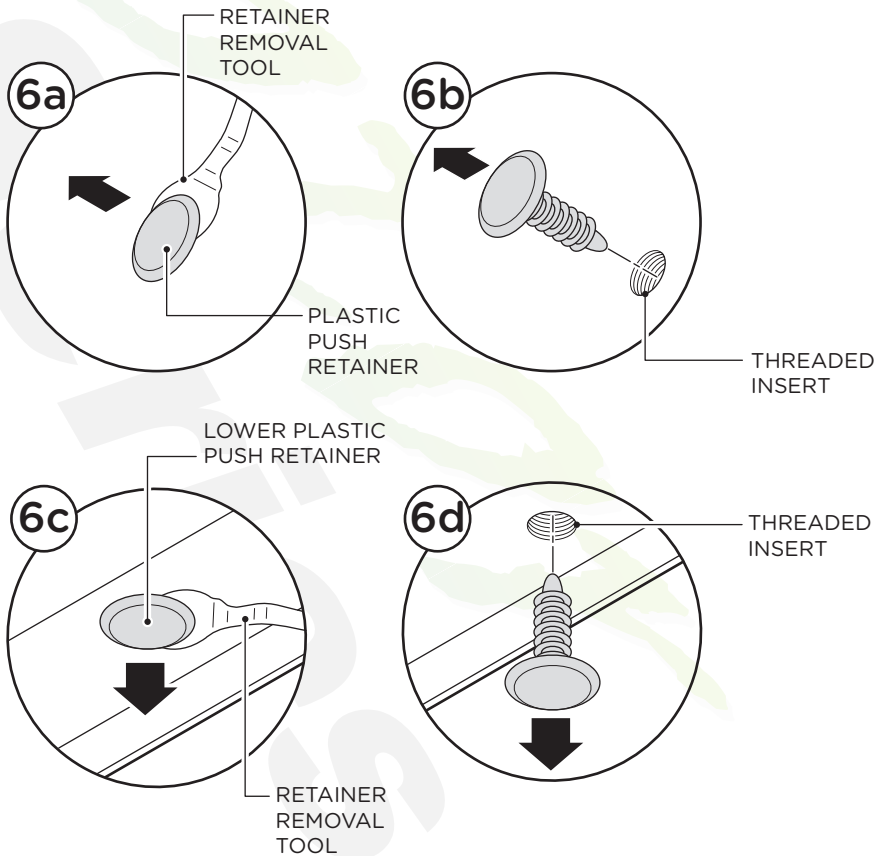

7. Fasten the top mounting point of each bracket to the rocker panel using one (1) M8 x 30 mm Hex Head Bolt, one (1) M8 Flat Washer and one (1) M8 Lock Washer (7a).

Complete installation of brackets by fastening the lower mounting point of each bracket to the pinch weld using one (1) M8 x 30 mm Hex Head Bolt, one (1) M8 Flat Washer and one (1) M8 Lock Washer (7b).

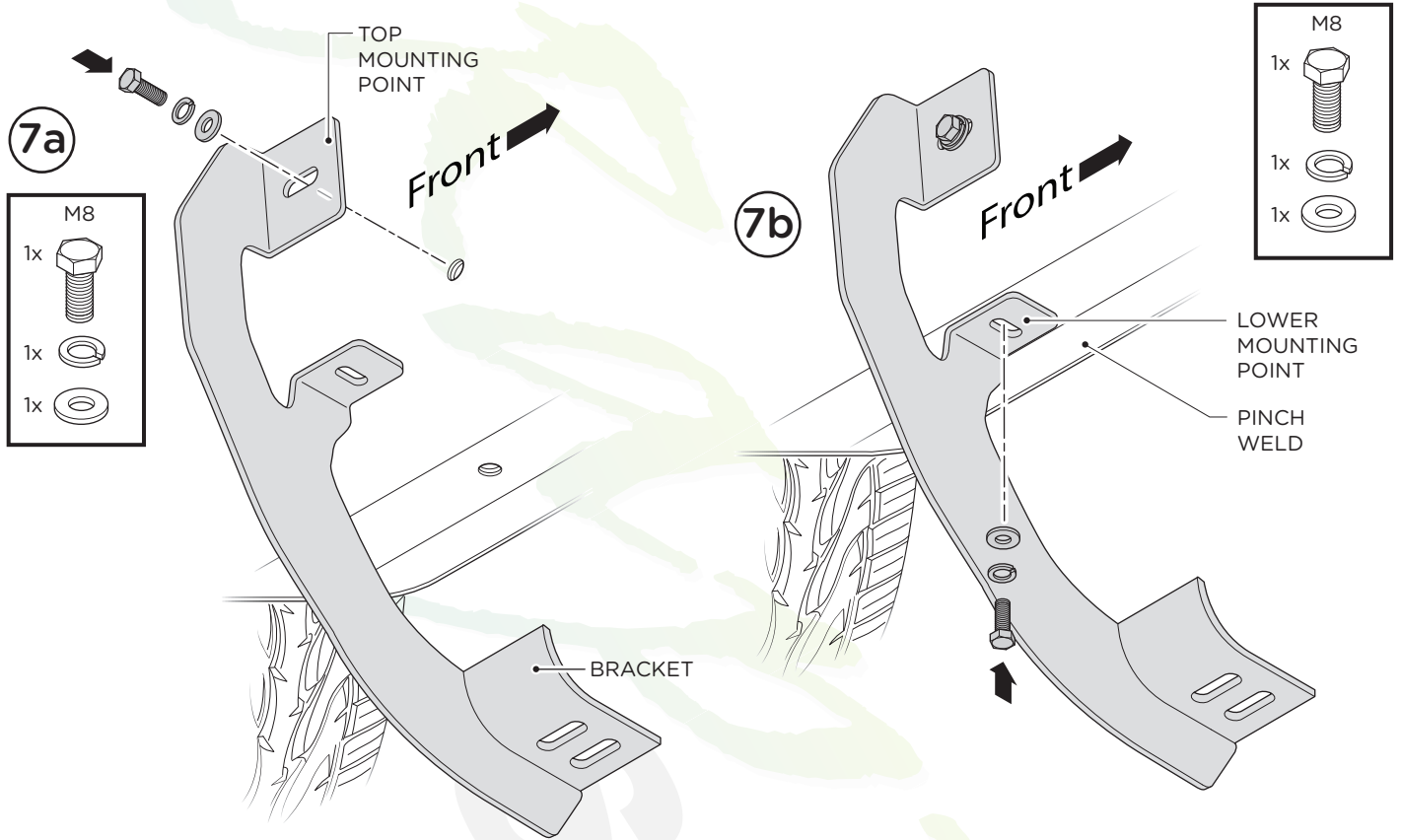

**8.** Place Step Bar and three (3) Rubber Gaskets onto Brackets. Each Step Bar is marked Driver and Passenger.

**9.** Install Step Bar and Rubber Gasket onto each Bracket and attach using two (2) M10 Button Head Bolts, two (2) M10 Lock Washers and two (2) M10 Flat Washers per bracket.

Tighten until the split lock washer is flat against bracket and snug. DO NOT over tighten and strip the threaded insert in the tube.

Repeat these steps for driver side installation. When all hardware is in place, everything must be tightened. See Page 1 for Torque Specifications.

