



GATORBACK MUDFLAPS

2019 Jeep Cherokee Trailhawk Mud Flap Set, Front Mounting Diagram & Instructions Kit# GCR61F

IMPORTANT:

Manufacturer is not responsible for negligent use of vehicle with mud flaps installed, including over-tightening of screws and bolts causing damage to vehicle or mud flaps.



TOOLS REQUIRED-

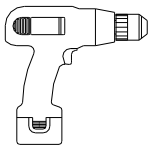

Electric or Rechargeable
Drill



1/4" Drill
Bit

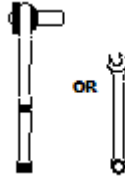

5/16" Open Wrench or
Socket Wrench

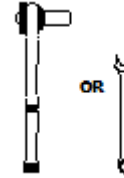

3/8" Open Wrench or
Socket Wrench

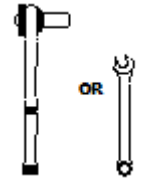

7/16" Open Wrench or
Socket Wrench

FLAPS

(1) Flap Assembly,
Front, DS

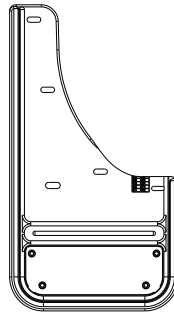

(1) Flap Assembly
Front, PS

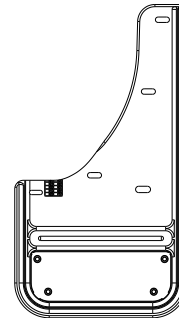

PARTS BAG # 767605

a) (2) Screw, Mach.
18-8SS, 10-24x1, Hex Hd
Part # 012022

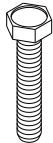

b) (6) Capscrew, SS
1/4"-20 x 3/8" Blk Ox
Part # 014069



c) (2) Capscrew, SS
1/4"-20 x 1" Blk Ox
Part #014073

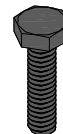

d) (4) Spring Nut
1/4"-20, 27/38" Reach
Part #028006

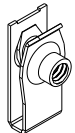

e) (4) Washer, Flat
0.203" x 0.781", SS
Part #018018

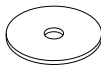

f) (2) Washer, Flat
0.281" x 1", SS
Part #018028

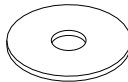

g) (8) Washer, Flat
0.281" x 1" SS, Blk Ox
Part #018069



h) (2) Washer, Flat
0.437" x 1", Nylon
Part #054076

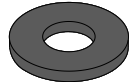

i) (2) Washer, Lock
1/4" Helicoil, SS
Part #024000

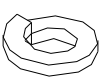

j) (2) Washer, Lock
18-8, SS, 10
Part #024001



k) (2) Nut, Hex
1/4"-20, SS
Part #025000

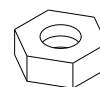

l) (2) Nut, Hex
#10-24, SS
Part #025003



m) (1) Front Bracket
Driver's Side
Part #767609

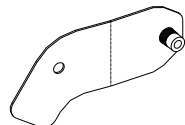

n) (1) Front Bracket
Passenger's Side
Part #767610

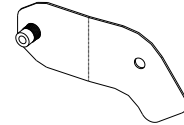

INSTALLATION (For ease of installation it is suggested that the wheel be removed)

1. Before you install your Mud Flap Set, see the diagram and parts list for all necessary parts. Start on the driver's side.
2. Install supplied bracket onto the mud flap through hole #1 and secure it with a nylon washer (054076), black washer (018069) and capscrew (014069).



3. Remove the lower factory screw from hole #7 as well as the corresponding factory push pin from the inside of the fender.
4. Install a capscrew (014073) through a black washer (018069) into mud flap hole #2 and bracket hole #6 and install on factory hole #7. Loosely secure using a flat washer (018028), lock washer (024000) and hex nut (025000)
5. Temporarily square the flap using a square or other levelling tool.
6. Mark the fender through mud flap holes #3 & #4.
7. Place spring nuts over marked spots on the fender. *Note* Spring nut marked through mud flap hole #3 will have to be installed at an angle as shown in the diagram.
8. Fit the flange of the spring nuts through the mud flap holes #3 & #4. Secure mud flap to spring nuts using a capscrew (014069) and a flat washer (018069)
9. Square the flap using a square or other levelling tool.
10. Drill a ¼" hole through mud flap hole #5 into the plastic liner to create hole #8
11. Install mud flap hole #5 to liner through hole #8 using a machine screw (012022) and flat washer (018018) and secure using a flat washer (018018), lock washer (024001) and hex nut (025003).
12. Tighten all fasteners.
13. Repeat procedure for passenger side.

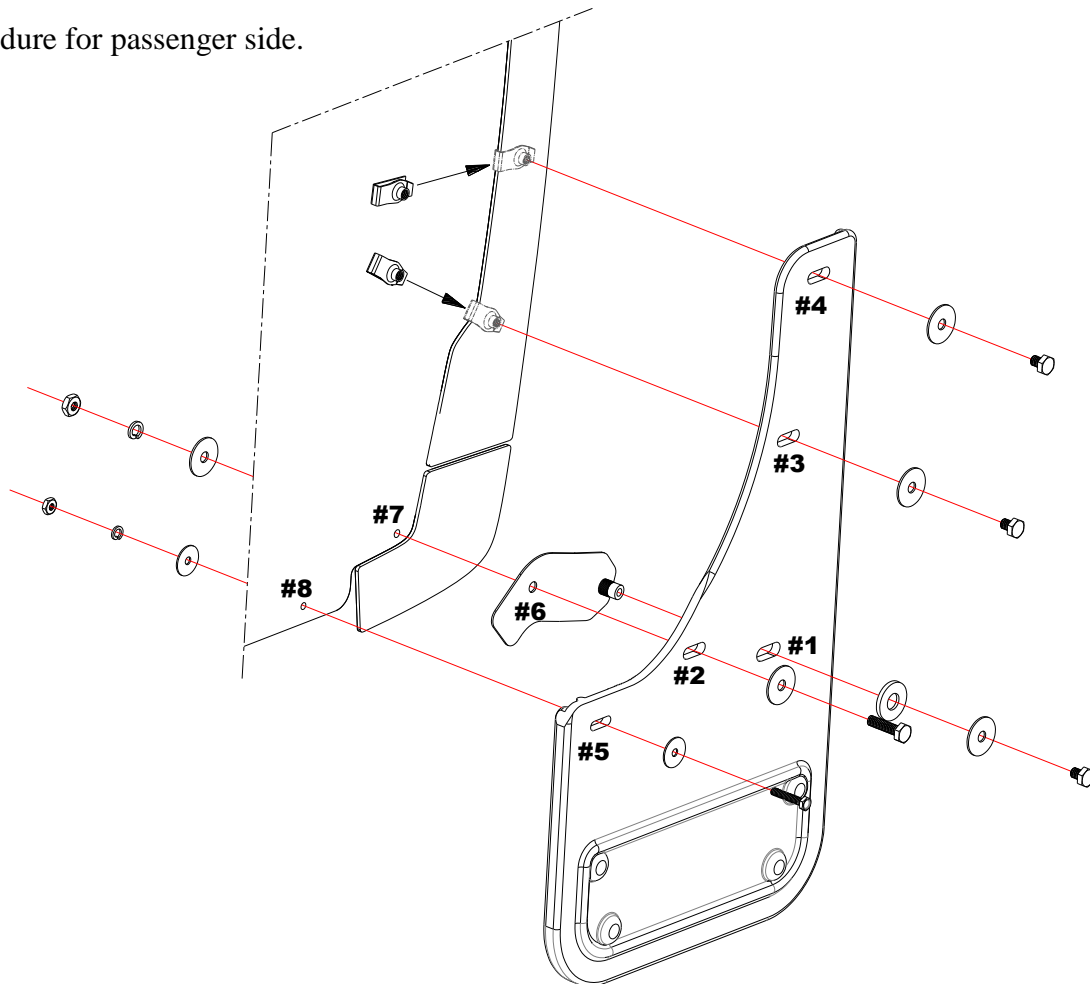

Please check out our YouTube channel to see an install video for this application.





GATORBACK MUDFLAPS

2019 Jeep Cherokee Trailhawk Mud Flap Set, Rear Mounting Diagram & Instructions Kit# GCR61R

IMPORTANT:

Manufacturer is not responsible for negligent use of vehicle with mud flaps installed, including over-tightening of screws and bolts causing damage to vehicle or mud flaps.



TOOLS REQUIRED-

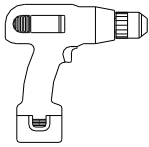

Electric or Rechargeable
Drill



1/4" Drill
Bit

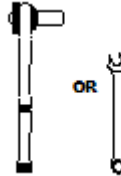

5/16" Open Wrench or
Socket Wrench

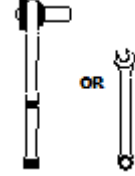

3/8" Open Wrench or
Socket Wrench

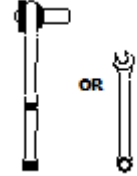

7/16" Open Wrench or
Socket Wrench

FLAPS

(1) Flap Assembly,
Front, DS

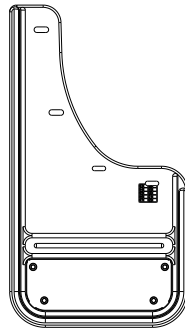

(1) Flap Assembly
Front, PS

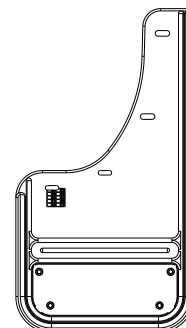

PARTS BAG # 767605

a) (2) Screw, Mach.
18-8SS, 10-24x1", Hex Hd
Part # 012022

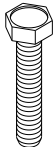

b) (4) Capscrew, SS
1/4"-20 x 3/8" Blk Ox
Part # 014069



c) (2) Screw, Sht Metal, SS
1/4"-Hex Washer Hd #8-18 x 2"
Part #016051



d) (4) Washer, Flat
0.203" x 0.781", SS
Part #018018

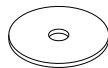

e) (2) Washer, Flat
0.203" x 1.5", SS, Blk Ox.
Part #018072

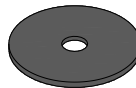

f) (4) Washer, Flat
0.281" x 1" SS, Blk Ox
Part #018069

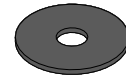

g) (2) Washer, Lock
18-8, SS, 10
Part #024001



h) (2) Nut, Hex
#10-24, SS
Part #025003



i) (4) Spring Nut
1/4"-20, 27/38" Reach
Part #028006



j) (2) Spacer, Nylon
1/2" x 1/4" x 7/8"
Part #054082



INSTALLATION *(For ease of installation it is suggested that the wheel be removed)*

1. Before you install your Mud Flap Set, see the diagram and parts list for all necessary parts. Start on the driver's side.
2. Remove the factory fender screw from hole #7
3. Install mud flap through hole #3 into factory hole #7 using a sheet metal screw (016051), a black washer (018072) and a spacer (054082)
4. Temporarily square the flap using a square or other levelling tool.



5. Mark the fender through mud flap holes #1 & #2.
6. Place spring nuts over marked spots on the fender.
7. Loosely secure mud flap holes #1 & #2 to spring nut holes #5 & #6 using a 1/4" screw (014069) and a black washer (018069)
8. Square the flap using a square or other levelling tool.
9. Drill a 1/4" hole through mud flap hole #4 into the plastic liner to create hole #8
10. Install mud flap hole #4 to liner through hole #8 using a machine screw (012022) and flat washer (018018) and secure using a flat washer (018018), lock washer (024001) and hex nut (025003).
11. Tighten all fasteners
12. Repeat procedure for passenger side.

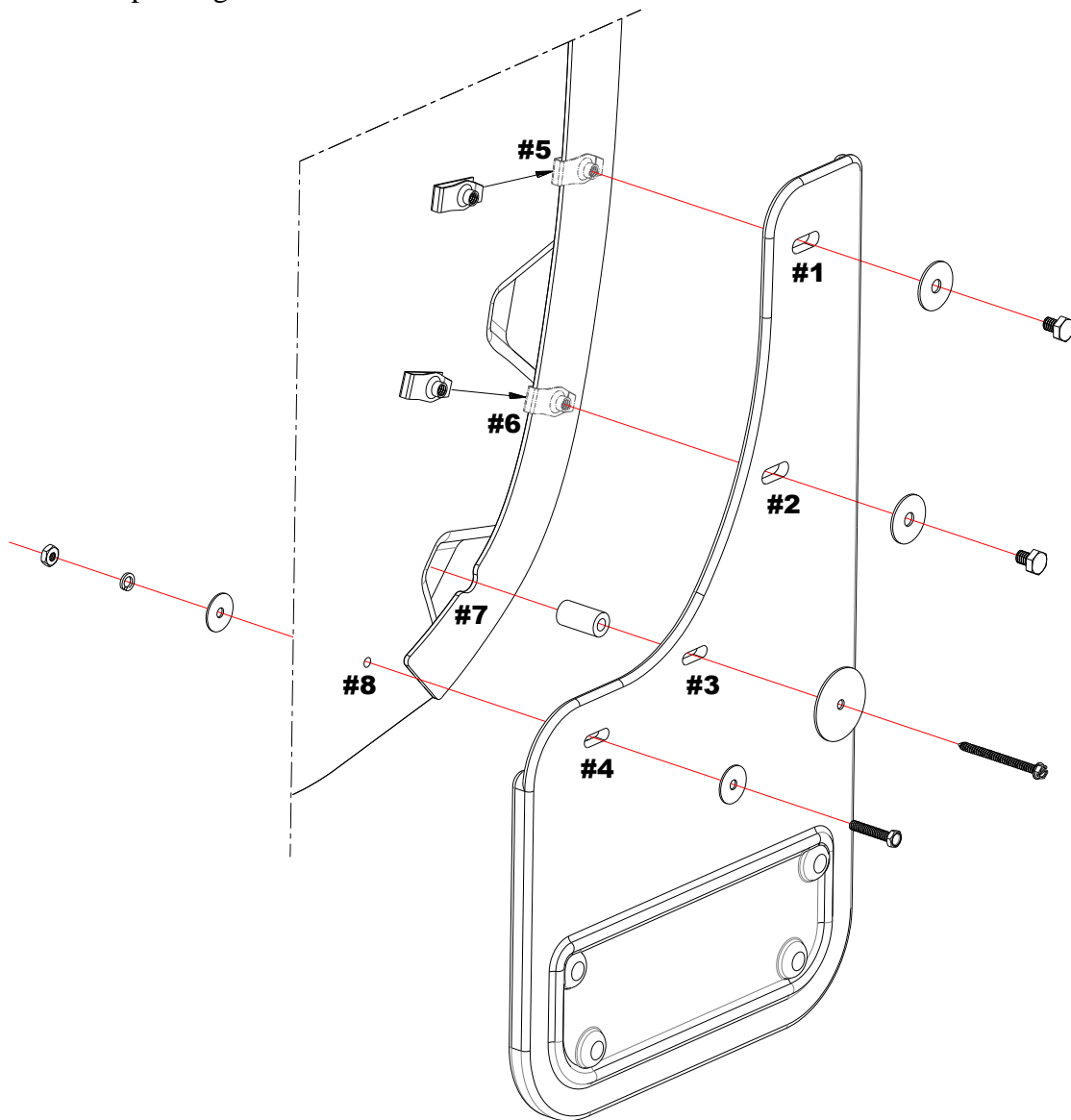

Please check out our YouTube channel to see an install video for this application.

