

LoadLifter 7500 XL™

ULTIMATE



Installation Guide



RAM 3500



Watch the video
Info on Table of Contents page

Kit 57531

For maximum effectiveness and safety, please read these instructions completely before proceeding with installation.

Failure to read these instructions can result in an incorrect installation.

TABLE OF CONTENTS

Installation Diagram	2
Hardware and Tools Lists	3
Introduction	4
Notation Explanation	4
Installing the System	5
Preparing the Vehicle	5
Assembling the Air Spring	6
Installing the Air Spring Assemblies	7
Installing the Air Lines	9
Finished Installation	10
Installation Checklist	11
Maintenance and Use Guidelines	11
Limited Warranty and Return Policy	12

Video-enhanced installation guides

Visit airliftcompany.com/workshop/category/install-videos to access our installation video archive*.

Installation Diagram

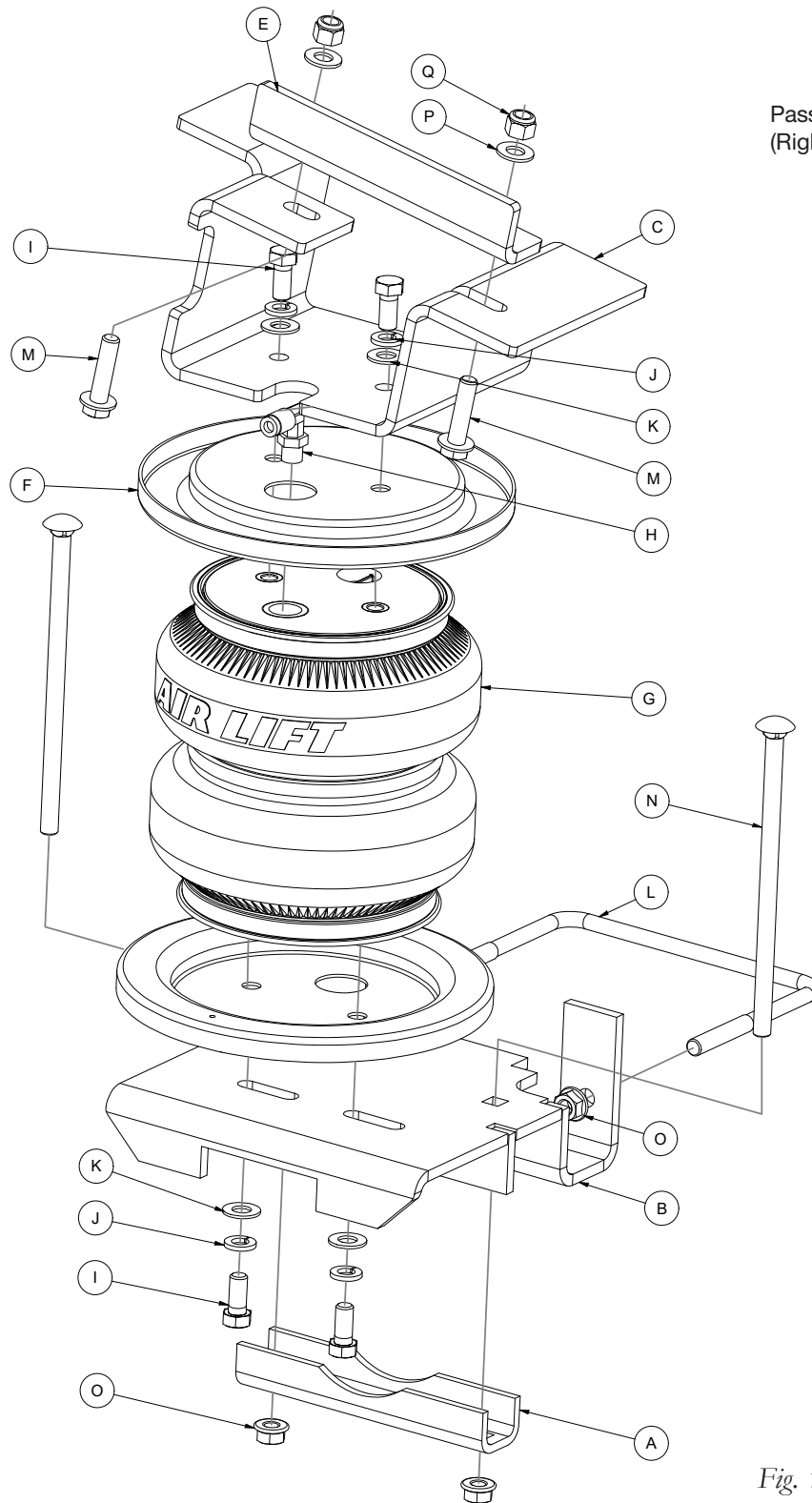

Fig. 1

Hardware and Tools Lists

HARDWARE LIST

Item	Part#	Description	Qty
A	01531	Clamp bar	2
B	03065	Lower bracket	2
C	07099	R.H. Upper bracket	1
D*	07157	L.H. Upper bracket	1
E	11655	Upper brace	2
F	11897	Roll plate	4
G	58120	Air spring	2
H	21837	90 degree Swivel elbow fitting	2
I	17203	3/8"-24 X 7/8" Hex head cap screw	8
J	18427	3/8" Lock washer	8
K	18444	3/8" Flat washer	8
L	11134	3/8"-16 X 4 5/8" U-bolt	2
M	17159	3/8"-16 X 1 1/2" Hex flange bolt	4
N	17163	3/8"-16 X 7" Carriage bolt	4
O	18422	3/8"-16 Serrated flange lock nut	8
P	18468	3/8" Flat washer	4
Q	18476	3/8"-16 Nylon lock nut	4
AA*	20086	Air line assembly	1
BB*	10466	Zip tie	6
CC*	18411	5/16" Lock washer	2
DD*	21234	Rubber washer	2
EE*	18501	M8 Flat washer	2
FF*	21233	5/16" Hex nut	4
GG*	21230	Valve cap	2

* These parts are not shown in the Installation Diagram (Fig. 1).

TOOLS LIST

Description	Qty
Standard and metric open-end or boxed wrenches	Set
Standard and metric regular and deep-well sockets	Set
Screwdriver	1
Ratchet	1
9/16" Ratchet wrench	1
Torque wrench	1
9/16" Crows-foot adapter	1
Hose cutter, razor blade, or sharp knife	1
Hoist or floor jack	1
Safety stands	2
Safety glasses	1
Air compressor or compressed air source	1
Spray bottle with dish soap/water solution	1



Missing or damaged parts? Call Air Lift customer service at (800) 248-0892 for a replacement part.

Introduction

The purpose of this publication is to assist with the installation and maintenance of the LoadLifter 7500 XL Ultimate air spring kit. LoadLifter 7500 XL Ultimate kits utilize sturdy, reinforced, commercial-grade double-convolute bellows.

The air springs are manufactured like a tire with layers of rubber and cords that control growth. LoadLifter 7500 XL Ultimate kits are recommended for most 3/4- and 1-ton pickups and SUVs with leaf springs and provide up to 7,500 pounds (3,402kg) of load-leveling support with air adjustability from 5-100 PSI (.34-7BAR).

It is important to read and understand the entire installation guide before beginning installation or performing any maintenance, service or repair.

NOTATION EXPLANATION

Hazard notations appear in various locations in this publication. Information which is highlighted by one of these notations must be observed to help minimize risk of personal injury or possible improper installation which may render the vehicle unsafe. Notes are used to help emphasize areas of procedural importance and provide helpful suggestions. The following definitions explain the use of these notations as they appear throughout this guide.



DANGER

INDICATES IMMEDIATE HAZARDS WHICH WILL RESULT IN SEVERE PERSONAL INJURY OR DEATH.



WARNING

INDICATES HAZARDS OR UNSAFE PRACTICES WHICH COULD RESULT IN SEVERE PERSONAL INJURY OR DEATH.



CAUTION

INDICATES HAZARDS OR UNSAFE PRACTICES WHICH COULD RESULT IN DAMAGE TO THE MACHINE OR MINOR PERSONAL INJURY.

Installing the System

PREPARING THE VEHICLE

1. Lift the vehicle and support the frame with safety stands. Drop the axle down low enough to later set the air spring assemblies into position between frame and axle (Fig. 2).

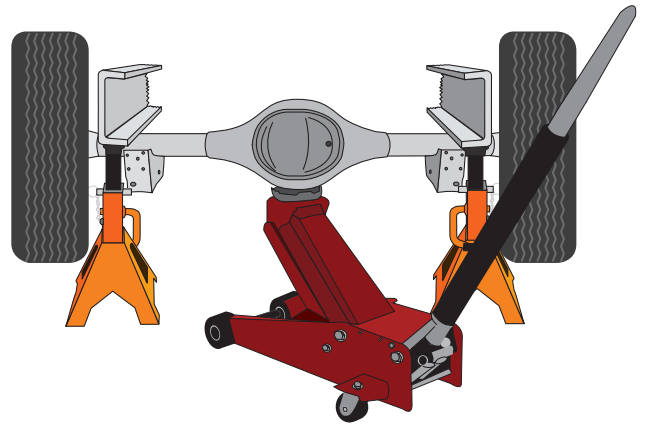

Fig. 2

2. Unbolt and remove both jounce bumpers (Fig. 3). Jounce bumpers and hardware will not be reused.



Fig. 3

3. Using a large regular screwdriver, pry out the axle vent tube line holder from the stock upper 5th wheel bracket (Fig. 4). Let the hose hang, it will be re-attached later in the installation.



Fig. 4

ASSEMBLING THE AIR SPRING

1. Place the roll plates (F) on the air springs (G). Install the 90 degree swivel elbow fittings (H) onto the air springs (Fig. 5). Tighten the air fittings finger-tight plus 1 1/2 turns.

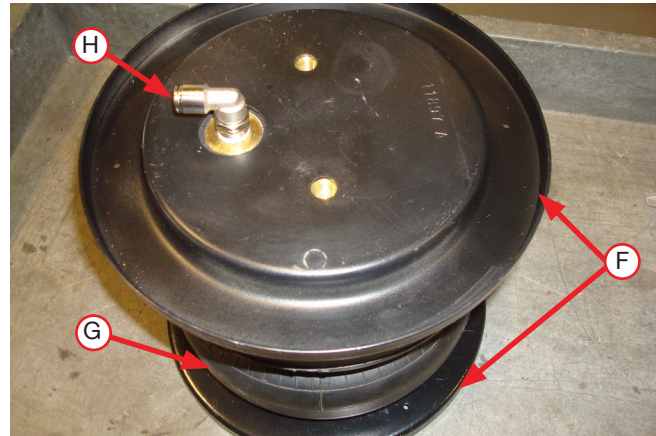

Fig. 5

2. Set the upper right-hand (C, pictured) and left-hand (D) air spring brackets onto the air spring assemblies and attach with 3/8" hex-head cap screws (I), lock washers (J) and flat washers (K) (Fig. 6). Torque to no more than 20 lb.-ft. (27Nm).

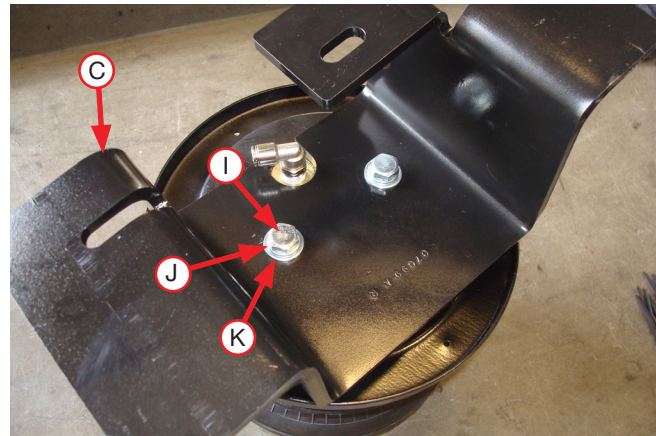

Fig. 6

3. Flip the assemblies over and adjust the roll plates position for mounting hole access. Insert two 3/8" carriage bolts (N) down through the top of the lower bracket (B) as shown (Fig. 7). Install the lower bracket onto the assemblies making sure the flange on the lower bracket is opposite of the fitting on top of the air spring. Attach with 3/8" hex-head cap screws (I), lock washers (J) and flat washers (K). Tighten hardware finger-tight only.

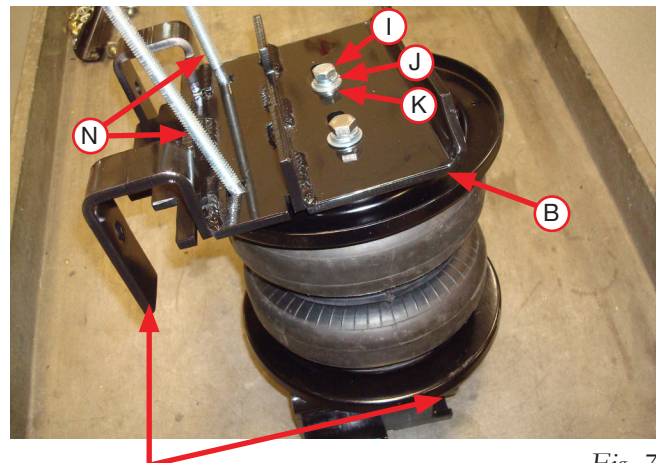

Fig. 7

Flange on lower bracket must be opposite of the fitting on the top of the assembly.

NOTE

FIGURE 8 SHOWS DRIVER'S (LEFT) SIDE AND PASSENGER'S (RIGHT) SIDE ASSEMBLIES.



Driver's (Left)
Side

Passenger's
(Right) Side

Fig. 8

INSTALLING THE AIR SPRING ASSEMBLIES

CAUTION

WHEN SETTING THE DRIVER SIDE ASSEMBLY INTO POSITION, BE CAREFUL NOT TO SET ASSEMBLY ONTO THE AXLE VENT TUBE FITTING AND HOSE (FIG. 9).

1. With the axle dropped as stated in step 1 of *Preparing the Vehicle*, set the left- and right-hand assemblies into position on the axle (Fig. 9).
2. On both sides, install the U-bolt (L) around the leaf spring stack and through the lower bracket flanges (Fig. 10). Install two 3/8" serrated flange lock nuts (O) onto the U-bolt and leave loose at this time. Push the lower bracket against the stock U-bolt stack as tight as possible.

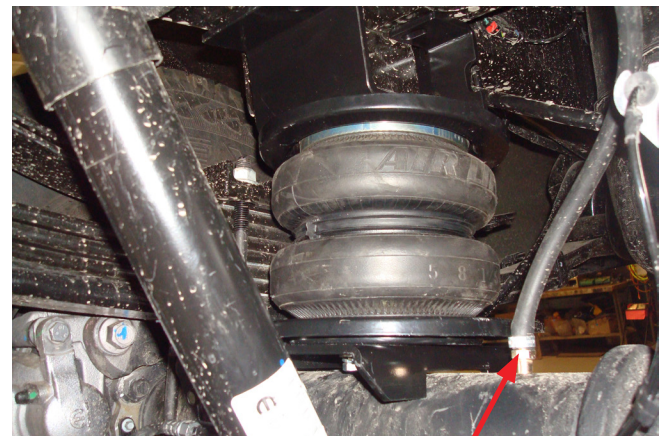

Vent tube fitting
and hose

Fig. 9

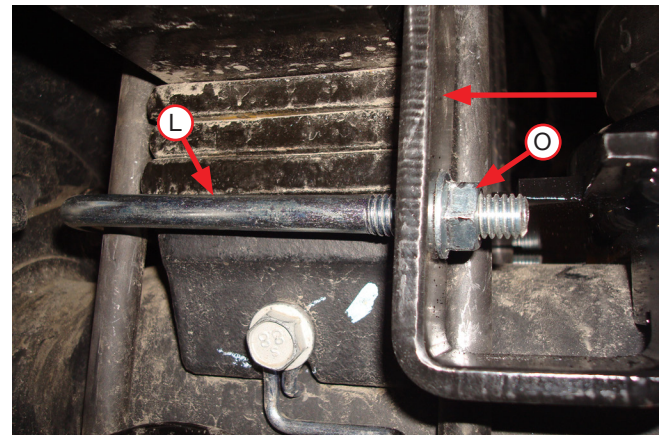
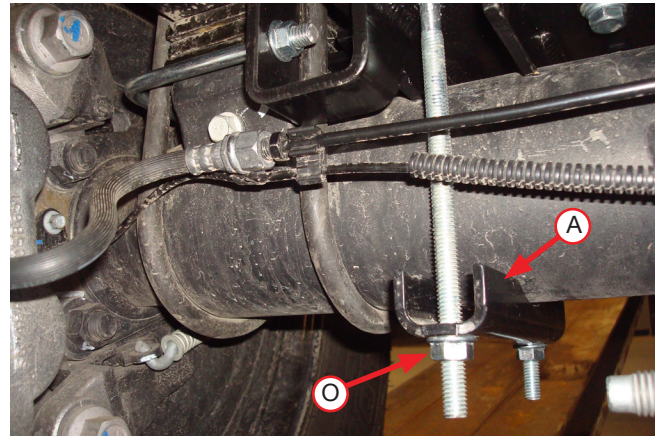
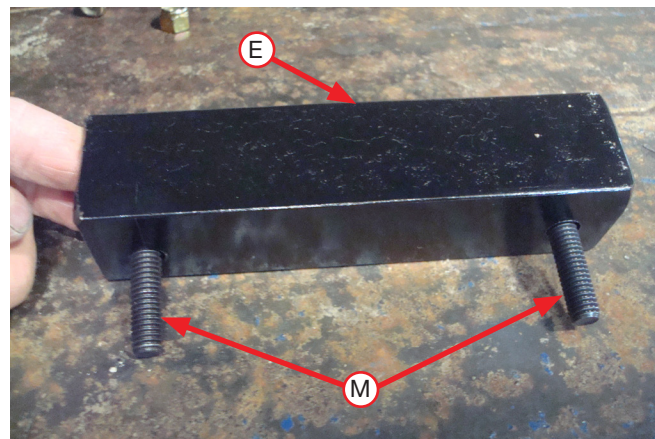

Fig. 10

3. Install the clamp bar (A) onto the carriage bolts under the axle (Fig. 11). Attach with two 3/8" serrated flange lock nuts (O). Using a 9/16" crows foot adapter, evenly torque the leaf spring U-bolts to 10 lb.-ft. (14Nm), then torque the lower axle clamp bar hardware to 16 lb.-ft. (22Nm). Repeat on the opposite side.

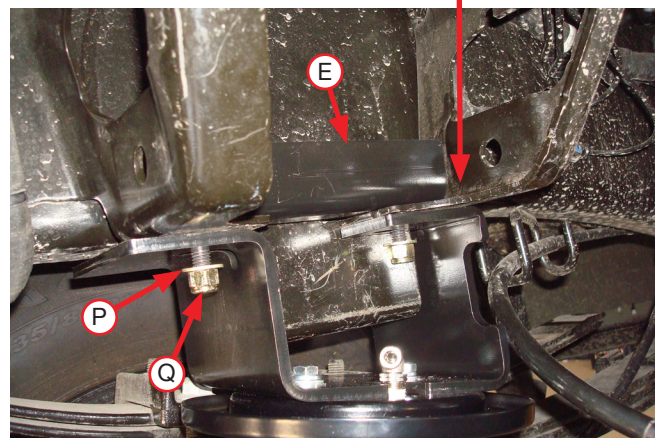

Fig. 11

4. Insert the 3/8" hex flange bolts (M) into the upper braces (E) (Fig. 12).

Fig. 12

Upper brace flange must face inward when installing onto the frame

5. Raise the axle up so that the upper brackets touch the frame. Set the brace assemblies created in step 4, with the flange on the brace facing inward, through the existing holes in the frame, then through the upper brackets (Fig. 13). Install the 3/8" flat washers (P) and lock nuts (Q) onto the bolts. Align the upper bracket by moving it in or out and torque the hardware to 31 lb.-ft (42Nm).

Fig. 13

- With the axle all the way up, align the lower air springs as perpendicular to the upper and lower brackets as possible. Tighten the air spring lower mounting bolts.

NOTE

IT MAY BE HELPFUL TO USE A 9/16" RATCHET WRENCH TO TIGHTEN THE BOLTS AND IT MAY BE REQUIRED TO FLIP THE OPEN END OF THE WRENCH OVER SEVERAL TIMES (ON THE SHOCK SIDE OF THE BRACKET) TO TIGHTEN THE BOLT FAR ENOUGH TO GET THE BOXED RATCHETING END ON THE BOLT.

- Re-attach the axle vent tube line holder that was removed in step 3 of *Preparing the Vehicle* and proceed with installing the air line.

Installing the Air Lines

- Choose the locations for the Schrader valves and drill a 5/16" (8mm) hole, if necessary (Fig. 14).

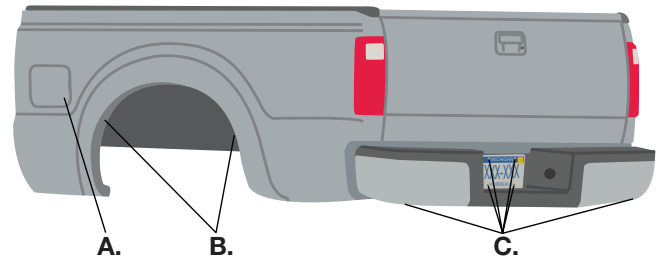

A. Inside fuel tank filler door
B. Inside rear wheel wells
C. License plate or rear bumper area

Fig. 14

- Cut the air line in half. Make clean, square cuts with a razor blade or hose cutter (Fig. 15). Do not use scissors or wire cutters.

CAUTION

KEEP AT LEAST 6" (152MM) OF CLEARANCE BETWEEN ALL AIR LINES AND THE EXHAUST SYSTEM. AVOID SHARP BENDS AND EDGES.

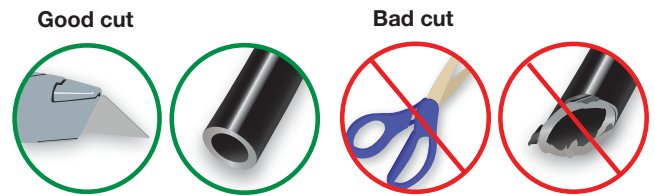

Fig. 15

- Use zip ties to secure the air line to fixed points along the chassis. Do not pinch or kink the air line. Leave at least 2" (51mm) of slack in the air line to allow for any movement that might pull on the air line. The minimum bend radius for the air line is 1" (25mm).

- Install the Schrader valve in the chosen location (Fig. 16).

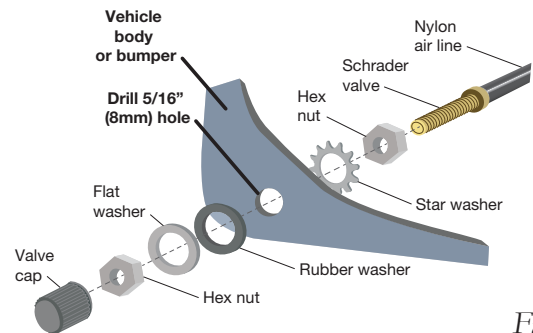
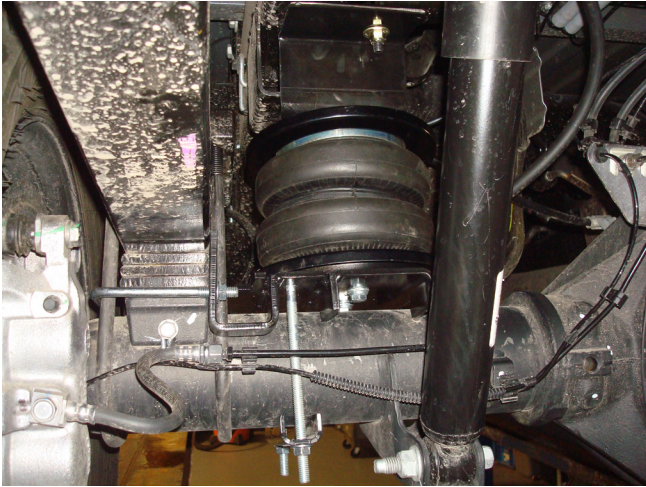

Fig. 16

Finished Installation

The images show the finished installation of both sides (Fig. 17 - Fig. 20).



Back view of driver's (left) side

Fig. 17



Back view of passenger's (right) side

Fig. 18



Inside view of driver's (left) side

Fig. 19

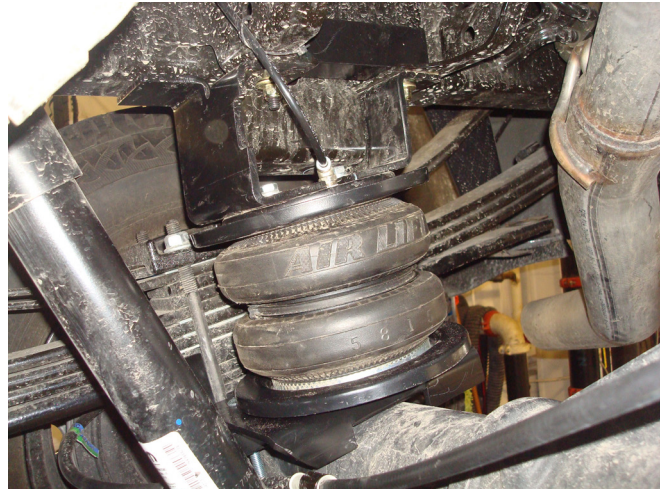

Inside view of passenger's (right) side

Fig. 20

INSTALLATION CHECKLIST

- Clearance test** — Inflate the air springs to 40-60 PSI (2.8-4.1BAR) and make sure there is at least 1/2" (13mm) clearance from anything that might rub against each air spring. Be sure to check the tire, brakes, frame, shock absorbers and brake cables.
- Leak test before road test** — Inflate the air springs to 40-60 PSI (2.8-4.1BAR) and check all connections for leaks. All leaks must be eliminated before the vehicle is road tested.
- Heat test** — Be sure there is sufficient clearance from heat sources, at least 6" (152mm) for air springs and air lines. If a heat shield was included in the kit, install it. If there is no heat shield, but one is required, call Air Lift customer service at (800) 248-0892.
- Fastener test** — After 500 miles (800km), recheck all bolts for proper torque.
- Road test** — The vehicle should be road tested after the preceding tests. Inflate the air springs to recommended driving pressures. Drive the vehicle 10 miles (16km) and recheck for clearance, loose fasteners and air leaks.
- Operating instructions** — If professionally installed, the installer should review the operating instructions with the owner. Be sure to provide the owner with all of the paperwork that came with the kit.

MAINTENANCE AND USE GUIDELINES

1. Check air pressure weekly.
2. Always maintain normal ride height. Never inflate beyond 100 PSI (7BAR).
3. If the system develops an air leak, use a soapy water solution to check all air line connections and the inflation valve core before deflating and removing the air spring.

Minimum Recommended Pressure
5 PSI (.34BAR)

Maximum Air Pressure
100 PSI (7BAR)

CAUTION

FOR SAFETY AND TO PREVENT POSSIBLE DAMAGE TO THE VEHICLE, DO NOT EXCEED MAXIMUM GROSS VEHICLE WEIGHT RATING (GVWR) OR PAYLOAD RATING, AS INDICATED BY THE VEHICLE MANUFACTURER.

ALTHOUGH THE AIR SPRINGS ARE RATED AT A MAXIMUM INFLATION PRESSURE OF 100 PSI (7BAR), THE AIR PRESSURE ACTUALLY NEEDED IS DEPENDENT ON LOAD AND GROSS VEHICLE WEIGHT RATING.



LIMITED WARRANTY AND RETURN POLICY

Air Lift Company provides a limited lifetime warranty to the original purchaser of its load support products, that the products will be free from defects in workmanship and materials when used on cars and trucks as specified by Air Lift Company and under normal operating conditions, subject to the requirements and exclusions set forth in the full Limited Warranty and Return Policy that is available at www.airliftcompany.com/warranty.

For additional warranty information contact Air Lift Company customer service.



Thank you for purchasing Air Lift Products — the Authorized Installer's choice!

Need Help?

Contact Air Lift Company Customer Service at (800) 248-0892
or email service@airliftcompany.com.

For calls outside the U.S. or Canada, dial (517) 322-2144.



MADE IN USA
WITH GLOBAL
COMPONENTS

Air Lift Company • 2727 Snow Road • Lansing, MI 48917 or P.O. Box 80167 • Lansing, MI 48908-0167

Air Lift Company reserves the right to make changes and improvements to its products and publications at any time.
For the latest version of this manual, contact Air Lift Company at (800) 248-0892 or visit airliftcompany.com.