



# GATORBACK MUDFLAPS

## Universal Nylon Offset Mud Flap Mounting Diagram & Instructions GN106 & GN107

### IMPORTANT:

The manufacturer is not responsible for negligent use of vehicle with mud flaps installed, including over-tightening of screws and bolts causing damage to vehicle or mud flaps.

Additionally, due the variances of lifts, tires, wheels, and offsets, it is the owners responsibility to determine if this is the correct mud flap for their application.

### TOOLS REQUIRED:

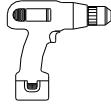

Electric or Re-Chargeable  
1/2" or 3/8" Drill



3/8" Socket Driver

### PARTS ENCLOSED: Parts Bag #770318 (Hardware) & 767491 (Caps)

(8) Tek Screw, SS, Blk Ox  
1/4"-14 x 1-1/4" HWH  
Part #010050

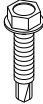

(8) Flat Washer  
0.281" x 1.5" SS, Blk Ox.  
Part #018087

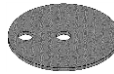

(2) Nylon Cap  
Driver Side  
Part #080642

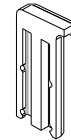

(2) Nylon Cap  
Passenger Side  
Part #080643

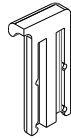

(2) Upper Mount  
Universal

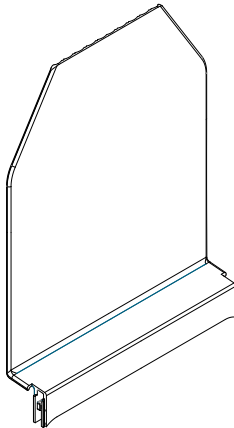

(2) Mud Flaps, Universal  
\*Note\* Product may  
vary dependent on  
size purchased

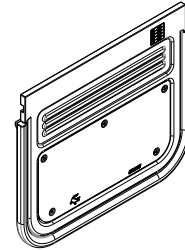

### ASSEMBLY:

1. Remove and discard the plastic strip inside the track at the bottom of the nylon upper mount.  
(See Diagram #1).
2. Slide rubber guide into track of nylon upper mount.
3. Install included caps on bottom of nylon upper mount. To fully lock this cap into place, you should hear two clicks, and cap will be even with the offset part of the upper mount. (See Diagram #1).
4. Repeat Procedure for second mud flap.

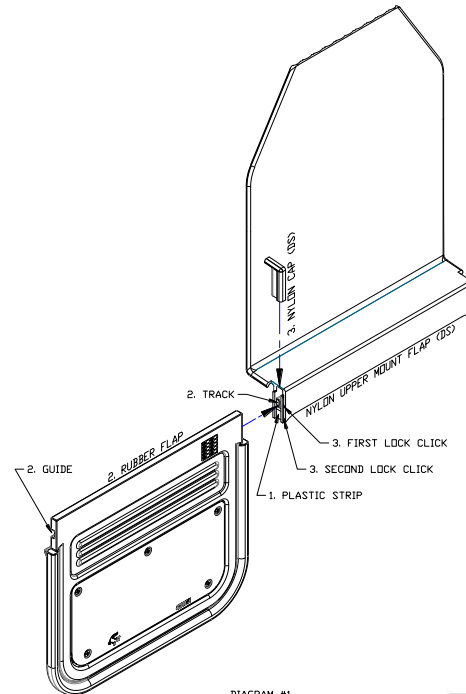

## INSTALLATION

*For ease of installation, it is suggested that the wheel be removed.*

1. Before you install your Mud Flap Set, see the diagram and parts list for all necessary parts. Start on the Driver's side.
2. Tuck the offset mud flap flange underneath the bottom of the wheel well and centered to the tire.
3. Square the flap with the tire while putting pressure against the wheel well and mark the center line of the wheel well on the tire side of the mud flap.
4. Now fasten the flap with four washers and four tek screws along the wheel well.
5. Repeat procedure for the passenger side. Ensure all fasteners are tight.

✓ Check all fasteners for tightness. Repeat procedure on the passenger side.

