



AUTOMOTIVE PRODUCTS,

INSTALLATION INSTRUCTIONS

PRO TRAXX 4 OVAL TUBE STEP BAR

APPLICATION:

2014+ Chevrolet Silverado / GMC Sierra 1500 Double / Crew Cab
 2015+ Chevrolet Silverado / GMC Sierra 2500/3500 HD Double / Crew Cab
 Gas & Diesel

PART NUMBER:

21-23710, 21-23715, 21-23720, 21-23725, 21-23850, 21-23855, 21-23860, 21-23865

ITEM	QUANTITY	DESCRIPTION	TOOLS NEEDED
1,2	2	STEP BAR, DRIVER (1) AND PASSENGER (2)	13MM SOCKET
3	4	MOUNT BRACKET B	13MM WRENCH
4	1	MOUNT BRACKET C	HEX KEY TOOL
5	12	M8 HEX HEAD CAP SCREW (BLACK ZINC) SEMS HARDWARE	RATCHET
6	12	M8 FLAT WASHER (BLACK ZINC) SEMS HARDWARE	TORQUE WRENCH
7	12	M8 SPRING LOCK WASHER (BLACK ZINC) SEMS HARDWARE	
8	12	M8 EXTRUDED U-NUT (YELLOW ZINC)	
9	12	M10 BUTTON HEAD SOCKET CAP SCREW (BLACK ZINC)	
10	12	M10 FLAT WASHER (BLACK ZINC)	
11	12	M10 INTERNAL TOOTHED LOCK WASHER (BLACK ZINC)	
12	12	M6 HEX HEAD CAP SCREW (YELLOW ZINC)	
13	24	M6 FLAT WASHER (YELLOW ZINC)	
14	12	M6 NYLON NUT (YELLOW ZINC)	
15	6	BRACKET PLASTIC COVER	
16	1	MOUNTING BRACKET D	

ANTI-SEIZE LUBRICANT MUST BE USED ON ALL STAINLESS STEEL FASTENERS TO PREVENT THREAD DAMAGE AND GALLING

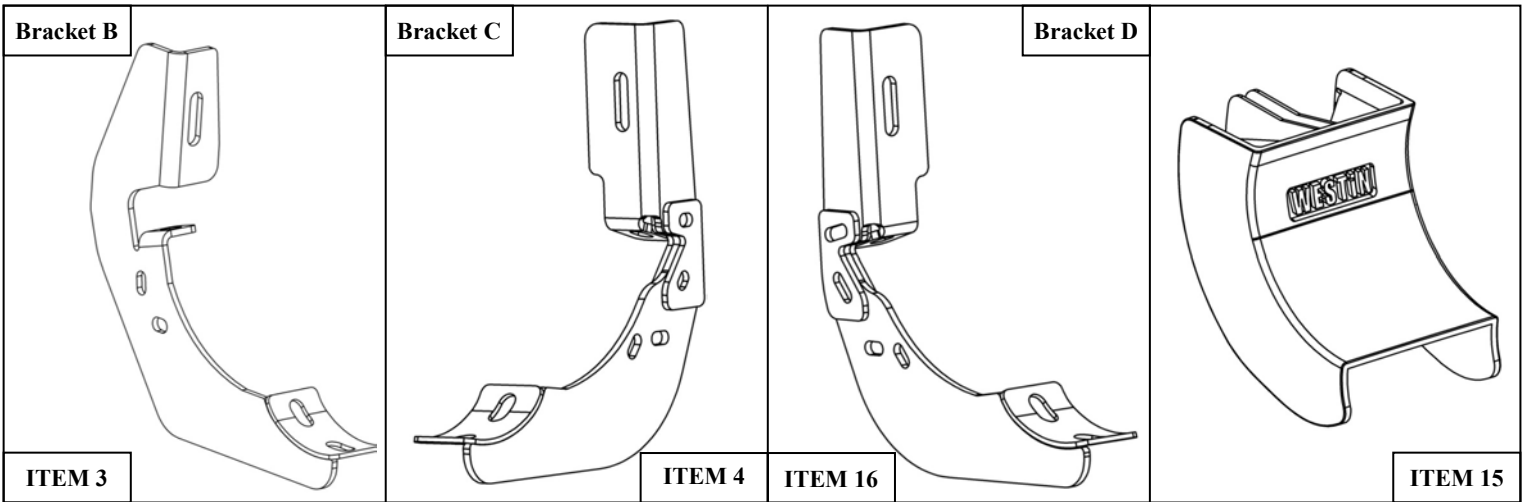

PROCEDURE

1. Remove contents from box, verify if all parts listed are present and free from damage. Carefully read and understand all instructions before attempting installation.

Failure to identify damage before installation could lead to a rejection of any claim.



Westin Automotive Products, Inc.
 320 W. Covina Blvd
 San Dimas, Ca. 91773

Thank you for choosing Westin products
 for additional installation assistance please call
 Customer Service (800) 793-7846

www.westinautomotive.com

2. Locate on each rocker panel the black rubber plugs and remove them. See **Figure 1**. Install the M8 nut clips (Item 8) as shown in **Figure 3**. For the bracket C (Item 4) mount location, install lower M8 clip (Item 8) as shown in **Figure 2**.
Note: On crew cab models, the front two mount locations will have pre-existing threads and will not require the upper M8 nut clips (Item 8) See **Figures 5 & 9**.

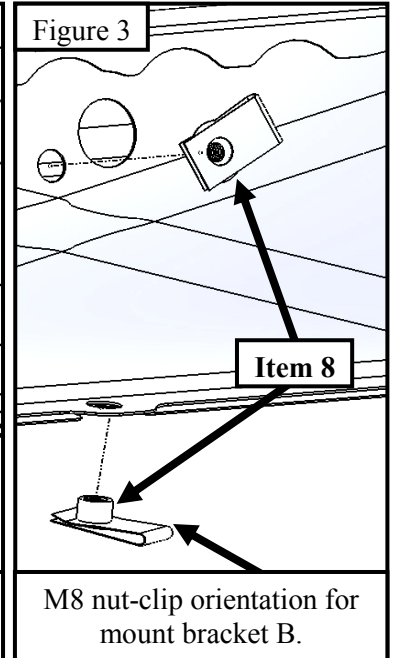
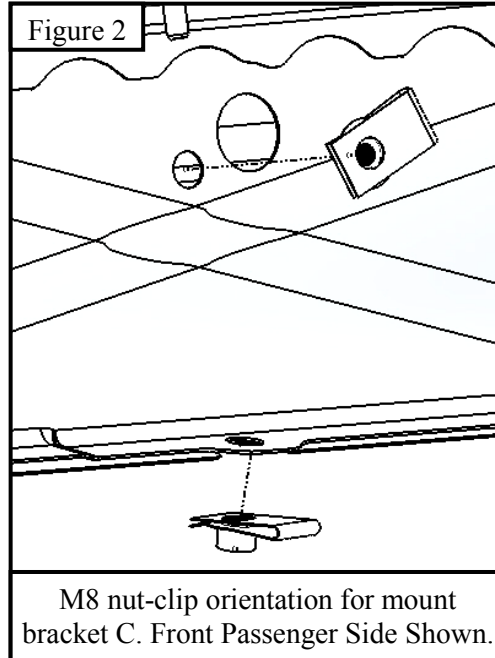
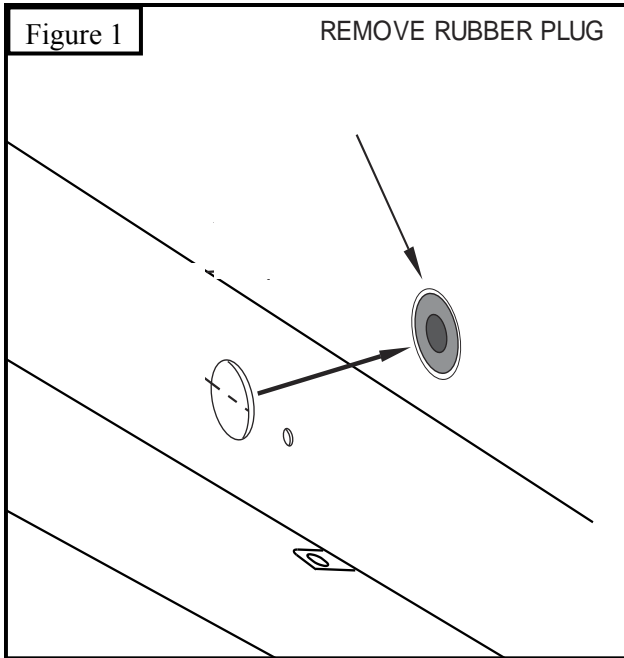

3. Take the mounting brackets and install the bracket and associated hardware loosely to its corresponding positions. For diesel model bracket locations see **Figures 4 and 5**. For gas model bracket locations see **Figures 8 and 9**. For hardware assembly see **Figure 6 and 7**. *Do not fully tighten hardware at this time.* **Note:** On 1500 crew cab models, front positions will have a welded nut on pinch weld and must refer to Figure 9 for bracket installation. **For 2015-2016 Diesel equipped models:** The D.E.F tank must be removed prior to installing the brackets on the passenger side. For D.E.F tank removal instructions please refer to **page 6**. **Note:** Bracket location is critical.

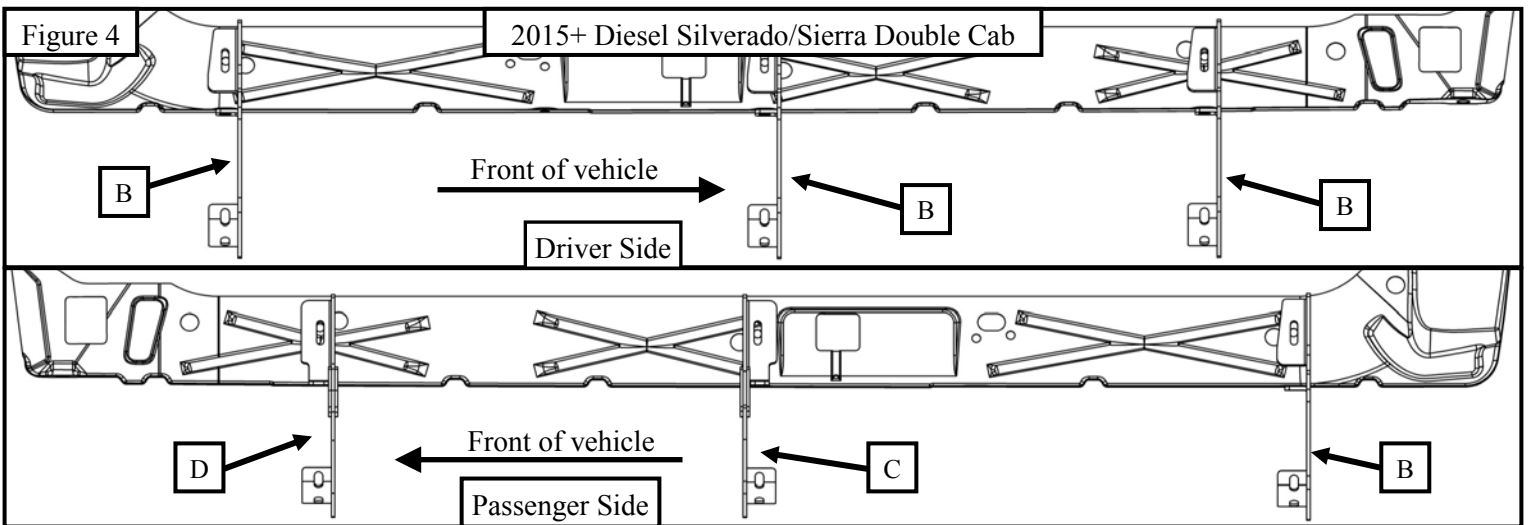

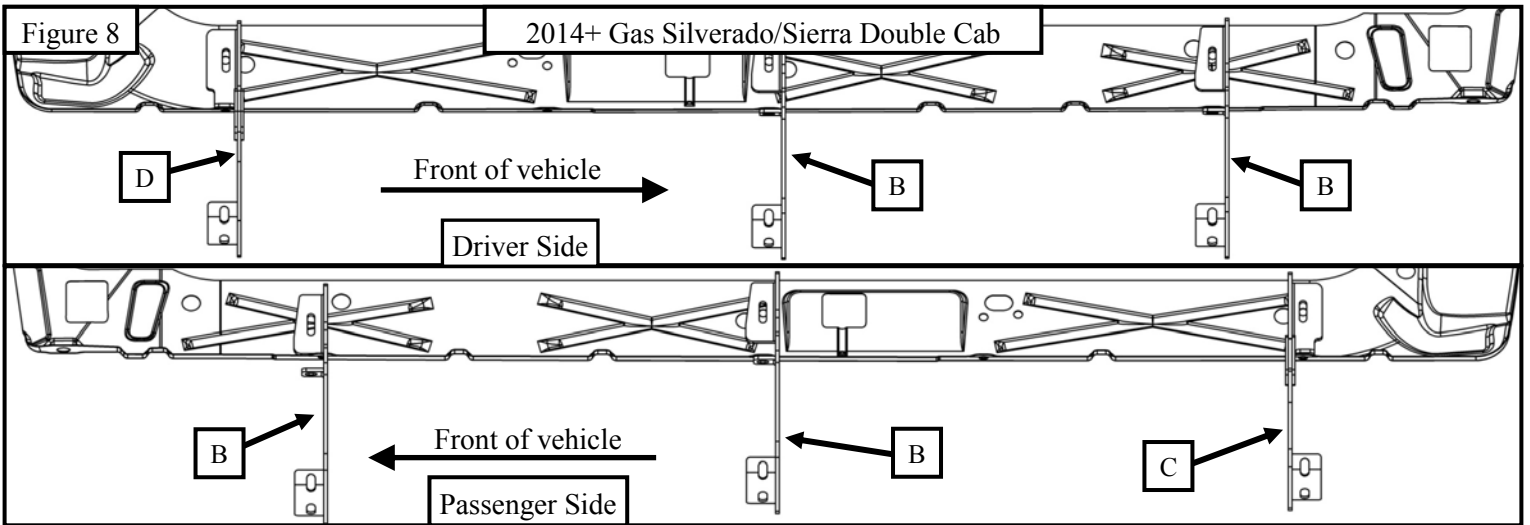
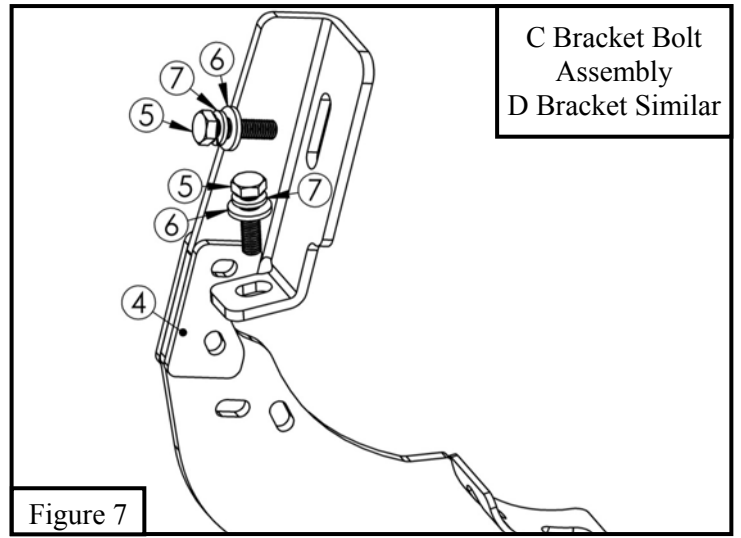
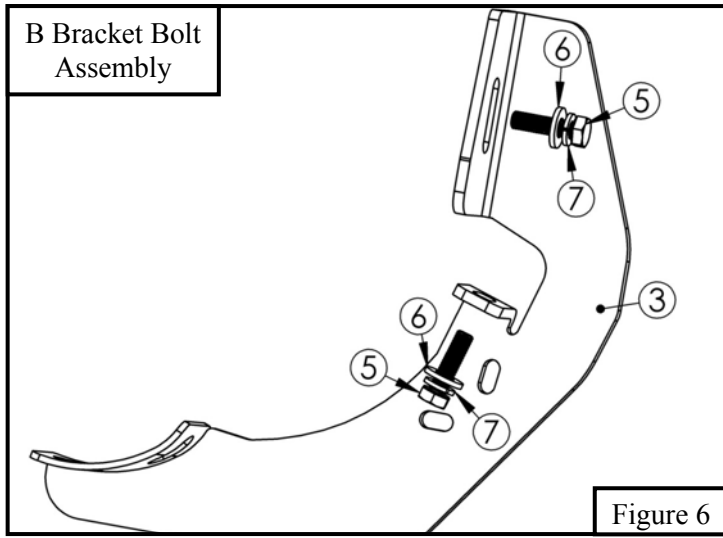
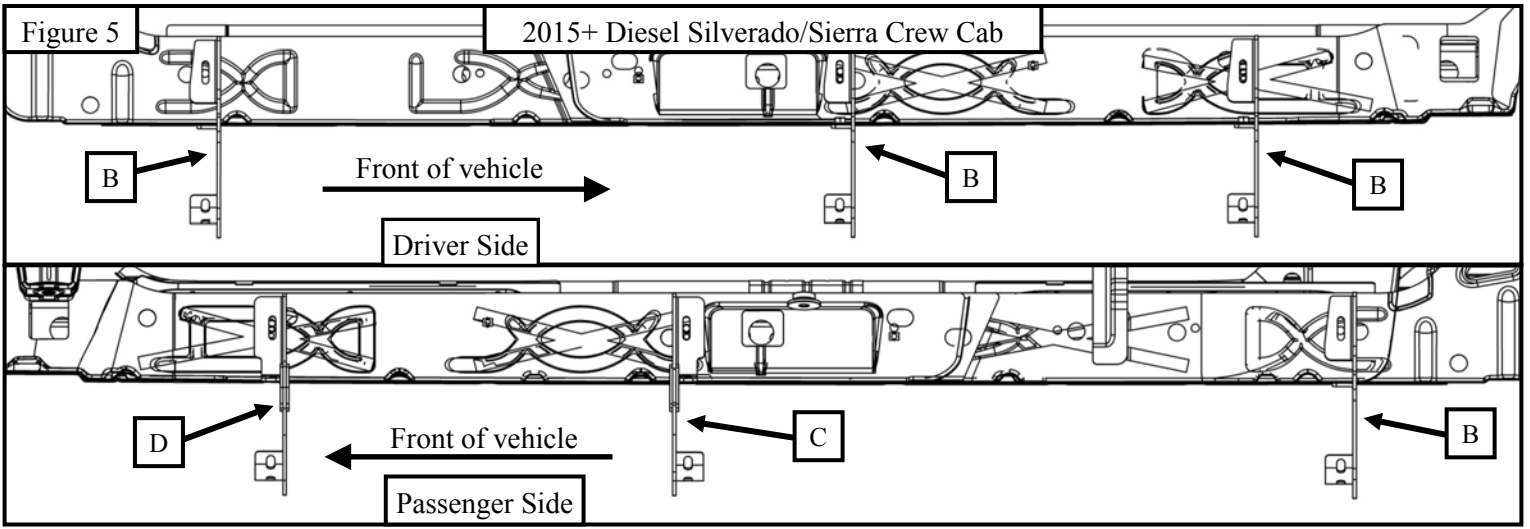

Westin Automotive Products, Inc.
320 W. Covina Blvd
San Dimas, Ca. 91773

Thank you for choosing Westin products
for additional installation assistance please call
Customer Service (800) 793-7846

www.westinautomotive.com

DATE: 3/6/17

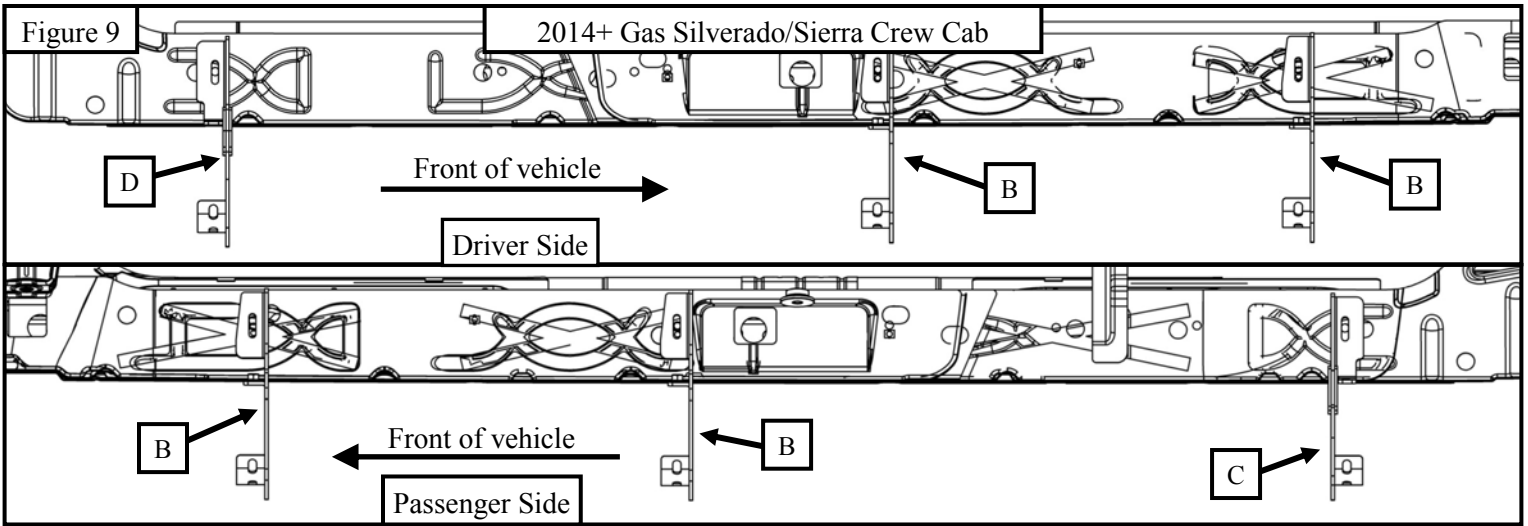

4. Locate (1) plastic bracket cover (Item 15) and loosely secure it to the (4) brackets using the provided hardware: (2) M6 hex head cap screws, (4) M6 flat washers, and (2) M6 nylon nuts. Repeat for every bracket. See **Figure 10**.
5. Take the passenger side step bar (Item 2) and place the step bar onto the mounting bracket cradles as shown in **Figure 12** (double cab models) and **Figure 13** (crew cab models). Secure the passenger side step bar using the M10 hardware (Item 9,10,11) as shown in **Figure 11**. Follow same steps to install the driver side step bar.
Note: The drivers side step bar will be packaged in a clear poly tube and the passenger side will be packaged in a red poly tube, the Westin logo should face outward when installed.
6. Make sure the mounting brackets and step bar are aligned then proceed to fully tighten all hardware. Recommended torque values are 15-18 ft-lbs for M8 fasteners, 30-35 ft-lbs for M10 fasteners, and 5-7 ft-lbs for M6 fasteners.
7. Proceed to reinstall the D.E.F tank on 2015+ models.

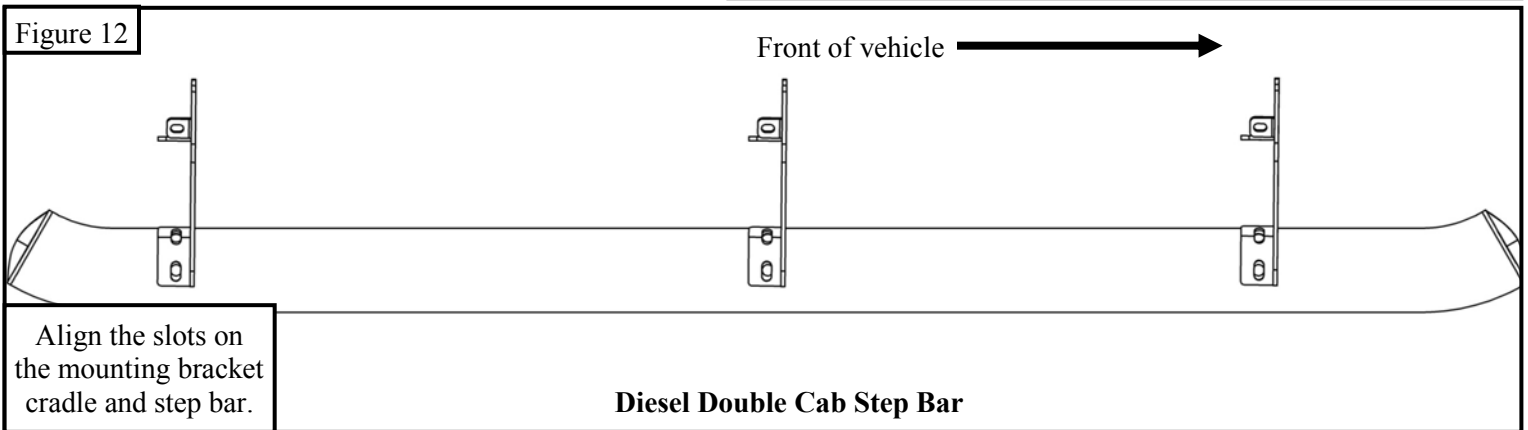
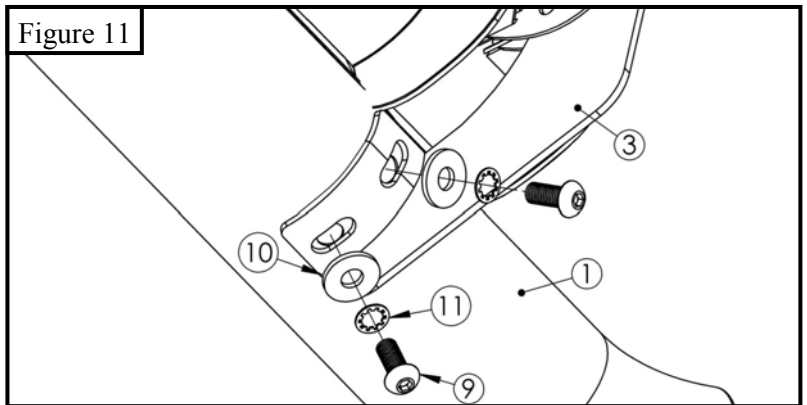
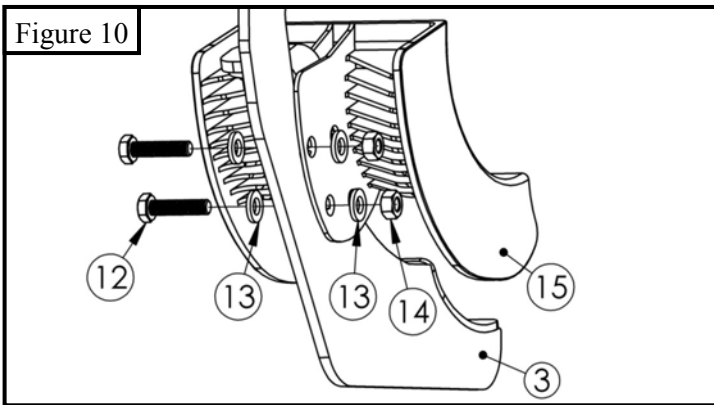
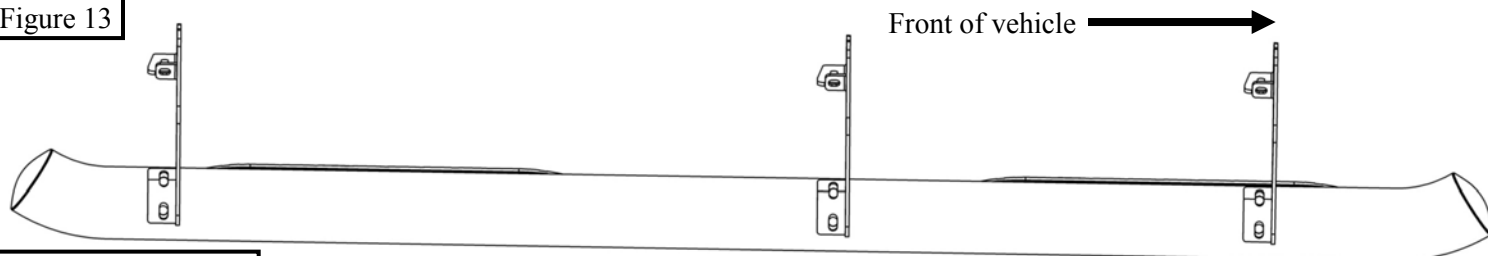
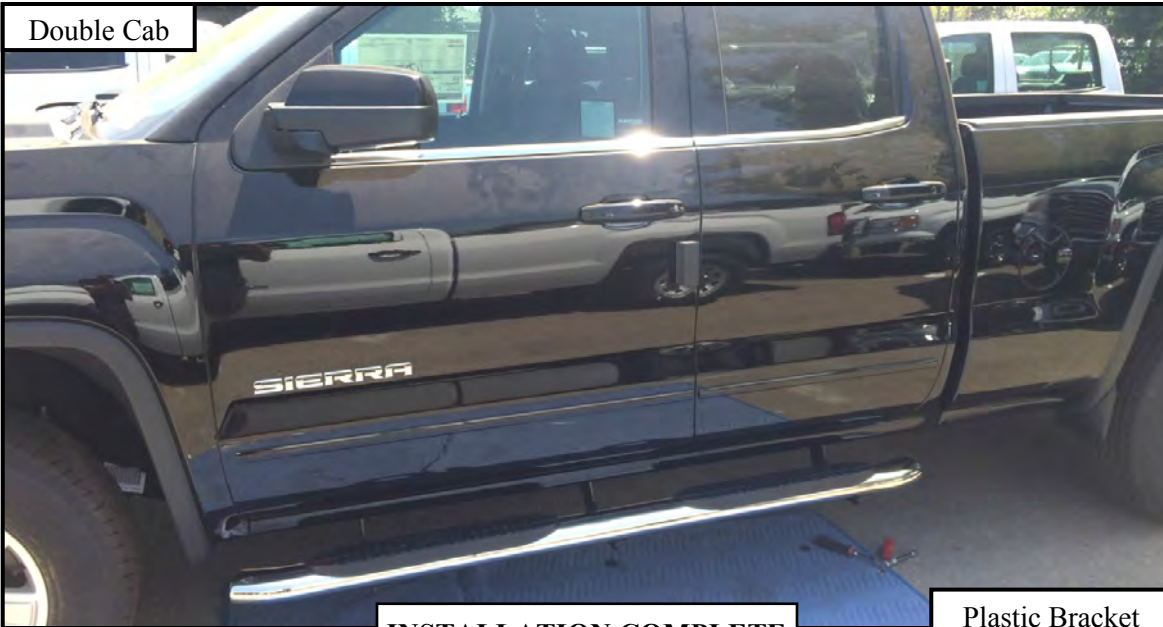

Figure 13



Align the slots on the mounting bracket cradle and step bar.

Diesel Crew Cab Step Bar



Double Cab

INSTALLATION COMPLETE

Plastic Bracket Covers not shown.



Crew Cab

Care Instructions

- REGULAR WAXING IS RECOMMENDED. DO NOT USE ANY TYPE OF POLISH OR WAX THAT MAY CONTAIN ABRASIVES.
- STAINLESS STEEL PRODUCTS CAN BE CLEANED WITH MILD SOAP AND WATER. STAINLESS STEEL POLISH SHOULD BE USED TO POLISH SMALL SCRATCHES.
- GLOSS BLACK FINISHES SHOULD BE CLEANED WITH MILD SOAP AND WATER.



Westin Automotive Products, Inc.
 320 W. Covina Blvd
 San Dimas, Ca. 91773

Thank you for choosing Westin products
 for additional installation assistance please call
 Customer Service (800) 793-7846
www.westinautomotive.com

DEF TANK REMOVAL INSTRUCTIONS FOR 11-16 DIESEL MODELS ONLY

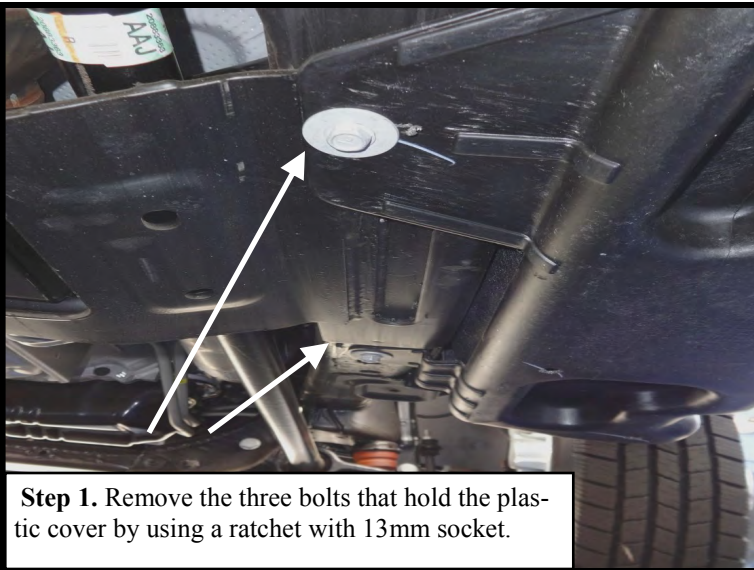

Step 1. Remove the three bolts that hold the plastic cover by using a ratchet with 13mm socket.

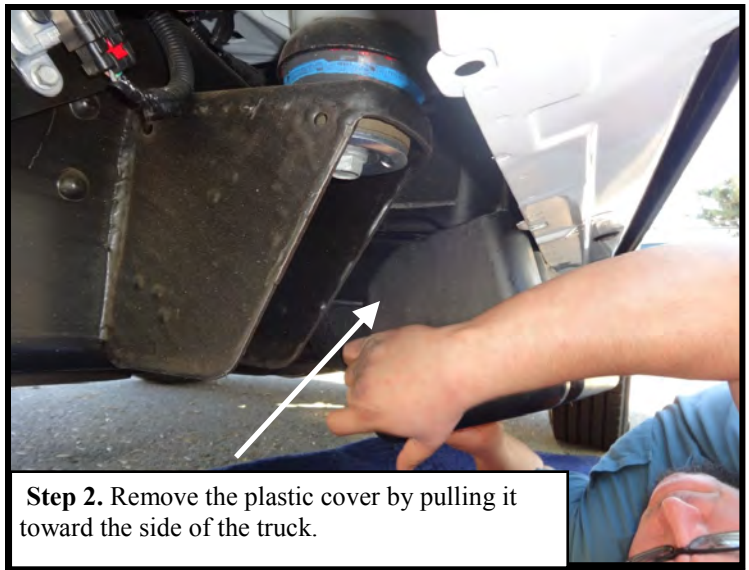

Step 2. Remove the plastic cover by pulling it toward the side of the truck.

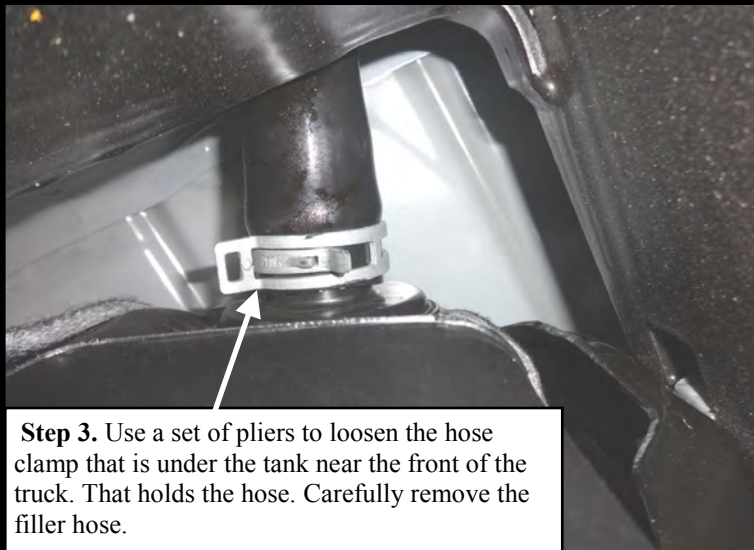

Step 3. Use a set of pliers to loosen the hose clamp that is under the tank near the front of the truck. That holds the hose. Carefully remove the filler hose.

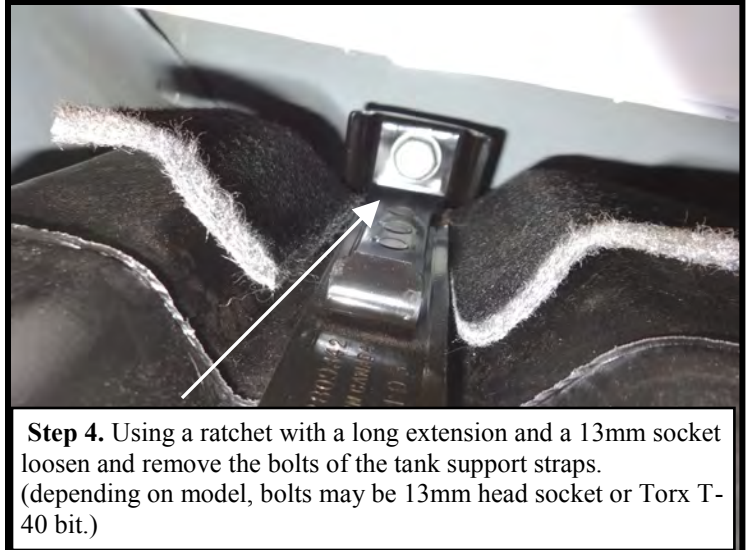

Step 4. Using a ratchet with a long extension and a 13mm socket loosen and remove the bolts of the tank support straps. (depending on model, bolts may be 13mm head socket or Torx T-40 bit.)

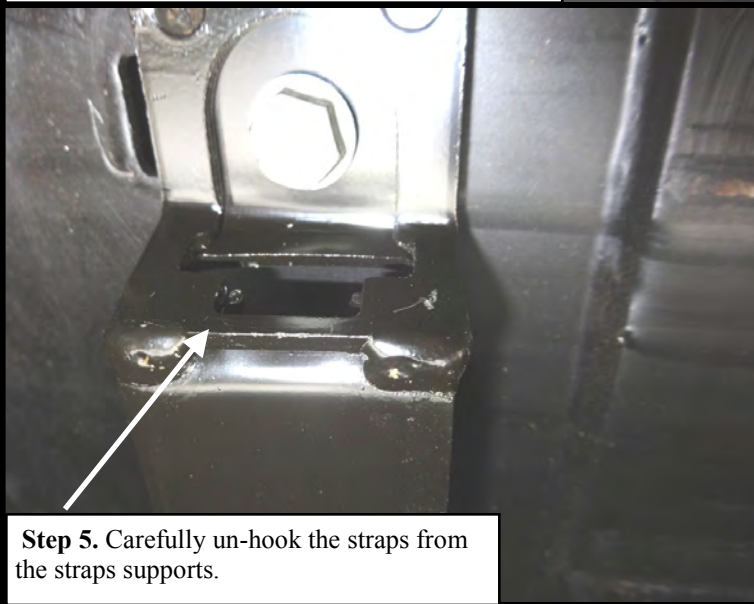

Step 5. Carefully un-hook the straps from the straps supports.

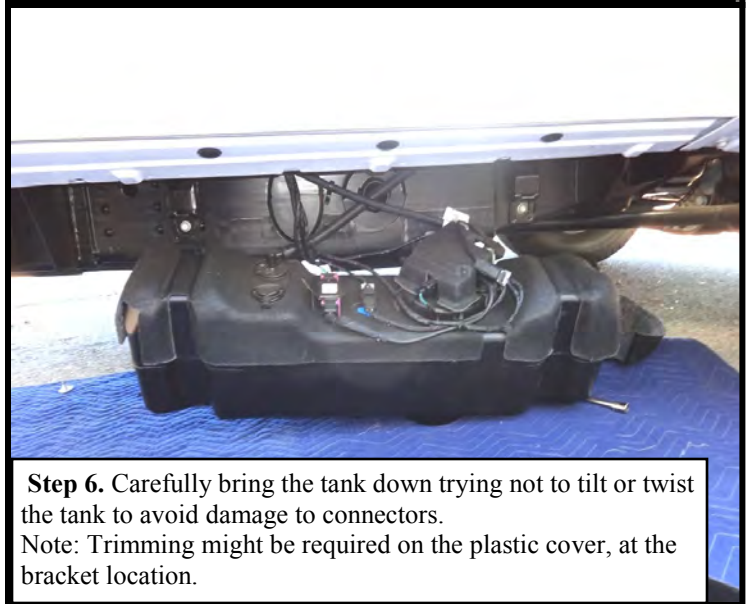

Step 6. Carefully bring the tank down trying not to tilt or twist the tank to avoid damage to connectors.
Note: Trimming might be required on the plastic cover, at the bracket location.



Westin Automotive Products, Inc.
320 W. Covina Blvd
San Dimas, Ca. 91773

Thank you for choosing Westin products
for additional installation assistance please call
Customer Service (800) 793-7846
www.westinautomotive.com



SIGNATURE OF QUALITY

AUTOMOTIVE PRODUCTS, INC.



WARNING



Failure to follow these instructions could lead to death, personal injury, and / or property damage.

FASTENERS:

All Westin supplied fasteners must be utilized and installed in accordance with the installation instructions and apply torque to the specifications as defined. **DOUBLE CHECK ALL FASTENERS BEFORE INITIAL USE, AND PERIODICALLY IN THE FUTURE TO ENSURE PROPER FUNCTION AND SAFETY.**

DRILLING:

Most Westin products do not require drilling for installation. If drilling is defined as required, use caution when drilling a vehicle. **FAILURE TO REVIEW AN AREA TO BE DRILLED MAY RESULT IN PERSONAL INJURY AND/OR INJURY TO OTHERS AS WELL AS VEHICLE DAMAGE.**

EYE PROTECTION:

ALWAYS WEAR SAFETY GLASSES OR GOGGLES DURING THE INSTALLATION PROCESS TO AVOID PERSONAL INJURY.

MAXIMUM TOWING/CARRYING CAPACITY:

The Westin Receiver Hitches will have a visible tow rating label affixed directly on the product. User should never exceed the vehicle manufacturers maximum tow and weight rating regardless of the capacity of the hitch. **FAILURE TO FOLLOW THESE GUIDELINES WILL VOID THE WESTIN WARRANTY AND MAY RESULT IN PERSONAL INJURY AND/OR INJURY TO OTHERS AS WELL AS VEHICLE DAMAGE.**



Westin Automotive Products, Inc.
320 W. Covina Blvd
San Dimas, Ca. 91773