

Work Truck Step Installation Instructions for Ford Transit Van-Side Door

Part No: 501070 / 501077

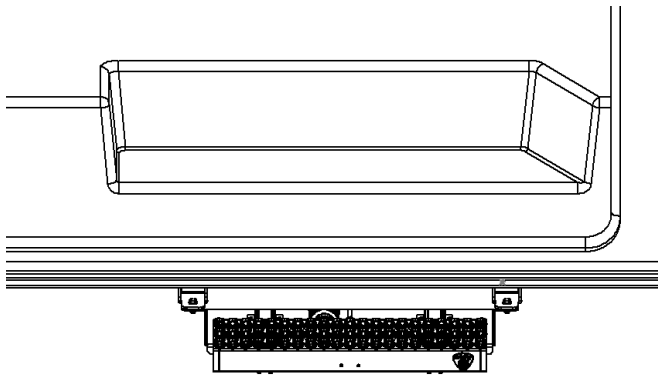

1. Mount the Front Steel Brackets to the pan with 5/16" hardware provided and hand-tighten them to the pan. Use the two 1" long 5/16" bolts for these brackets.

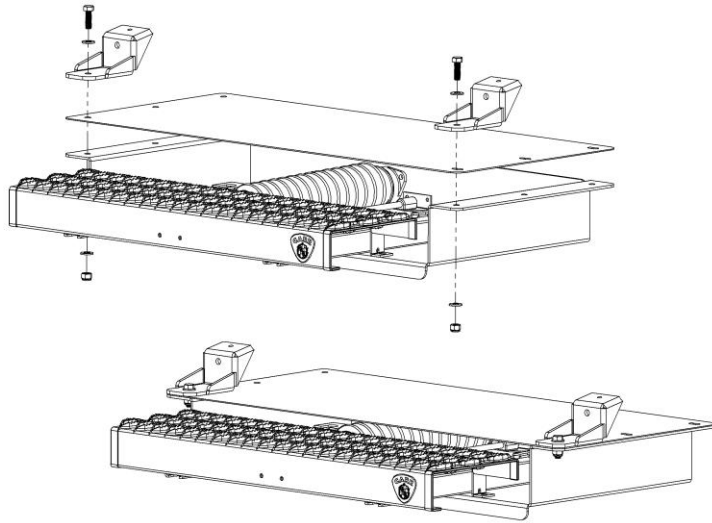

2. From underneath vehicle, position the step assembly centered on the open step area of the van as shown. You will need to use a floor jack or some way to hold the step in this position for the next step.

3. Make sure the Front Mounting Brackets are up against the vertical and top angled horizontal body metal surfaces.

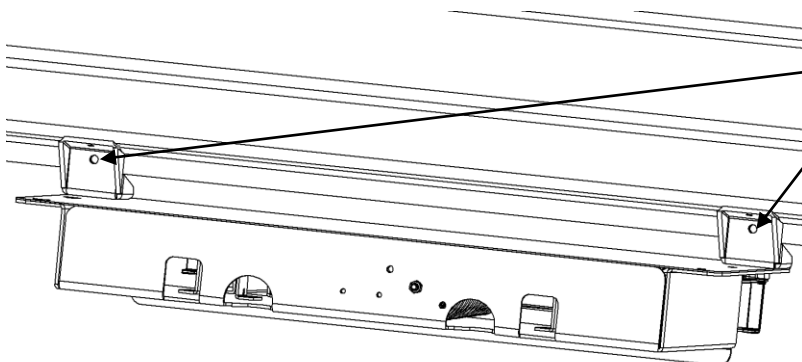
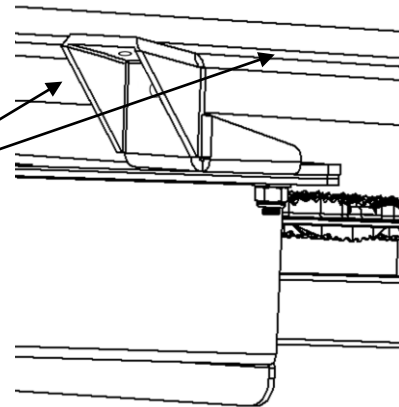

4. With the step assembly in position and the Front Mounting Brackets up against the body metal, mark two holes using the holes in the Front Mounting Brackets as a guide. Lower the step assembly and drill out the marked holes with an 11/32" drill bit.

Work Truck Step Installation Instructions for Ford Transit Van-Side Door

Part No: 501070 / 501077

5. With the holes in the body metal, take the two Blind Retainer Nuts and insert them between the body metal and the plastic molded cover. You will need a flat blade screw driver to carefully bend the plastic molded cover down so you don't break the plastic or the clips holding it on.

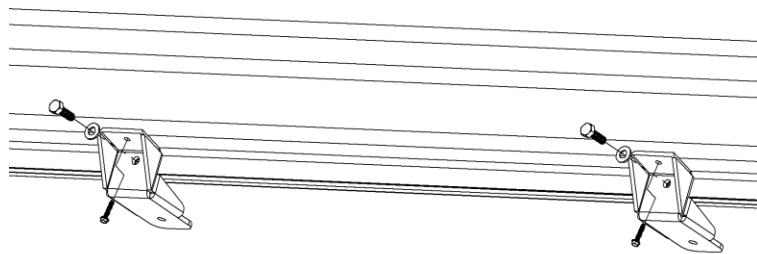
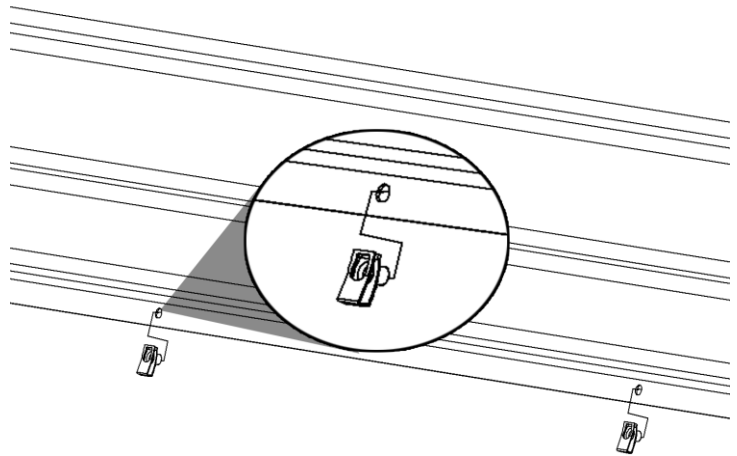

6. Place the Front Mounting Brackets back into place. With the Blind Retainer Nuts installed, use the 5/16" X 1" bolts with the flat washers and tighten both brackets to the vehicle. Take the two 1/4" self-tapping screws and install them through the 1/4" holes on the top of the Front Mounting Brackets. An impact wrench will make this easier.

7. Place the step assembly back into place. Use the 5/16" X 1" hardware used in step 1 to reinstall the step assembly. Securely tighten the hardware. If the holes do not line up, loosen the other hardware enough to get all hardware aligned and then securely tighten the hardware.

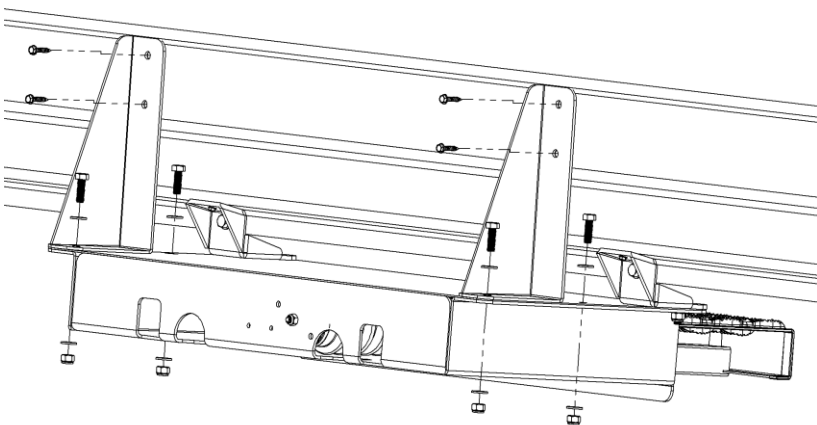
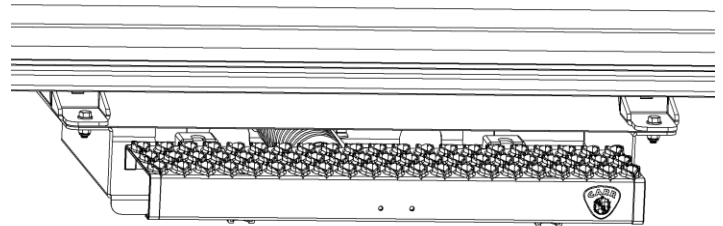

8. Place the Rear Mounting Brackets on the back of the step assembly. Make sure the top of the Rear Mounting Brackets are flat against the body metal. Take the remaining 5/16" hardware and securely tighten the Rear Mounting Brackets to the step assembly and the center holes of the cover to the step assembly. Make sure the step assembly is level to your vehicle. With the step assembly in that position take the 5/16" self-tapping screws, using the four holes at the top of each Rear Mounting Bracket, and securely tighten the Brackets to the vehicle. An impact wrench will make this task easier. Now your step is ready to go! Push your step in to either lock or unlock it.

Work Truck Step Installation Instructions for Ford Transit Van-Side Door

Part No: 501070 / 501077

WARNINGS!

- ✓ FOR SAFE AND PROPER USAGE OF THIS PRODUCT, THE MOUNTING INSTRUCTIONS MUST BE FOLLOWED CAREFULLY AND COMPLETELY.
- ✓ The manufacturer and distributor of this product are in no way responsible for the consumer's failure to adhere to the warnings and directions of these instructions in the event of damage to the consumer's vehicle, other properties and or personal injury.



Quality and Style that Endures

Follow the diagram and the written directions carefully for a proper, safe installation.

Should you encounter an unusual, unforeseen problem, contact our Technical Help Line 7:00 AM – 3:00 PM Pacific Time

(800) 800-1084

Visit our web-site at

www.CARR.com

Warranty Information
on our website

Carr Pattern Co., Inc.



Installation video:

<https://youtu.be/RSIrlaFzWpU>

Vehicle Application:

'13-'22 Ford Transit Van Side Door

MATERIALS NEEDED:

- * Drill motor
- * Impact wrench (if available)
- * 11/32 drill bit
- * Pencil or some marking device
- * 2 – 1/2" wrenches or sockets
- * 1 – 7/16" socket
- * 1 – 3/8" socket

MATERIAL FURNISHED:

- * Step Assembly
- * 2 – Front Mounting Brackets
- * 2 – Rear Mounting Brackets
- * 1 – Cover Plate
- * Hardware installation pack
- * Instruction sheet

Installation time for one step
assembly – 45 minutes

Carr Pattern Co., Inc. Warranty Policy

Finishes: Limited Lifetime

Structural Warranty: Limited Lifetime

Warranty Conditions:

- All warranties start from consumer's date of purchase.
- A new product will be sent out immediately to replace a warranty claim.
- The above guidelines apply only to the Original Purchaser.
- Original proof of purchase must be submitted for all warranty and returns issues.

Warranty Limitations:

- Warranty coverage extends ONLY to repair or replacement of the CARR product. This warranty does not cover the cost of labor, transportation, installation or removal of the product.
- Warranty coverage does not extend to damage caused by: collision, fire, theft, freezing, vandalism, riot, explosion or object striking the product, or misuse of the product and/or the vehicle on which the product is being installed.
- Warranty coverage does not extend to damage caused by: airborne fallout (chemicals, tree sap, etc.), stones, hail, earthquake, water or flood, windstorm, lightning, the application of chemicals or sealants subsequent to manufacture.
- Warranty coverage does not extend to damages caused by: normal wear and tear, abuse, modification or improper installation of the product.
- Warranty coverage does not extend to any economic loss or extra expense including (without limitation), payment for the loss of time or pay, inconvenience, storage, loss of vehicle use, vehicle rental expense, equipment rental expense, lodging, meals, or other travel costs.

Other Terms:

This warranty gives you specific legal rights and you may also have other rights that vary from state to state. CARR does not authorize any person to create for it any other obligation or liability in connection with its products. ANY IMPLIED WARRANTY OF MERCHANTABILITY OR FITNESS FOR A PARTICULAR PURPOSE APPLICABLE TO THIS PRODUCT IS LIMITED IN DURATION TO THE DURATION OF THIS WRITTEN WARRANTY. PERFORMANCE OF REPAIRS AND NEEDED ADJUSTMENTS IS THE EXCLUSIVE REMEDY UNDER THIS WRITTEN WARRANTY OR ANY IMPLIED WARRANTY. CARR SHALL NOT BE LIABLE FOR INCIDENTAL OR CONSEQUENTIAL DAMAGES RESULTING FROM BREACH OF THIS WRITTEN WARRANTY.*

*Some states do not allow limitations on how long an implied warranty will last or the exclusion or limitation of incidental or consequential damages, so that above limitations or exclusions may not apply to you.

Guarantee: Every attempt has been made to manufacture and distribute the finest quality products available. Our manufactured products are guaranteed to be free of defects due to workmanship or materials. Distributed products are subject to manufacturer's warranty only.