

IMPORTANT:

Manufacturer is not responsible for negligent use of vehicle with mud flaps installed, including over-tightening of screws and bolts causing damage to vehicle or mud flaps.

NO-DRILL SYSTEM

TOOLS REQUIRED-

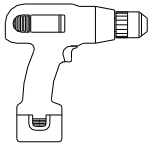

Electric or Rechargeable Drill



1/4" Drill Bit



Push Pin Removal Tool

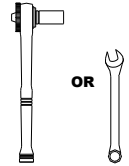

10mm Open Wrench or Socket Wrench

FLAPS & BRACKETS

(1) Flap Assembly, Front, DS Part #766543

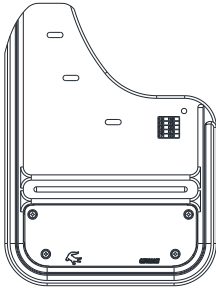

(1) Flap Assembly, Front, PS Part #766544

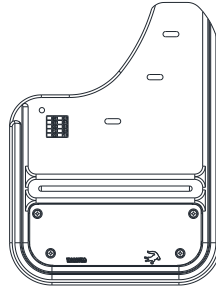

(2) Front Washer Plate Part #766539

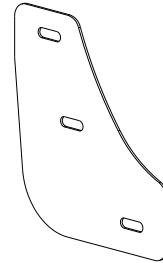

PARTS BAG # 766540

a) (2) Screw, Machine SS, #18-8, 10-24 x 1" Hex Part #012022



b) (6) Screw, Sheet Metal SS, Blk, M4.2 x 1" Part #016041



c) (4) Washer, Flat 0.203" x 1", SS Part #018031



d) (6) Washer, Flat 0.203" x 1", Alum. Part #018053

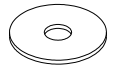

e) (2) Washer, Lock 18-8SS, 10 Helicoil Part #024001



f) (2) Nut, Hex SS, #10-24 Part # 025003



g) (6) Spring Nut #28, 9/16" Reach Part # 028004



INSTALLATION *(For ease of installation it is suggested that the wheel be removed)*

1. Before you install your Mud Flap Set, see the diagram and parts list for all necessary parts.
2. Remove the (3) factory push pins on the inside of the fender and the (1) factory push pin on the underside of the fender.
3. Pull back the plastic guard and inner liner to reveal the factory holes that contained the factory push pins.
4. Install the (3) spring nuts onto each of the (3) factory holes #8 to #10. (See Diagram #2)
5. Move plastic guard back into place and reinstall the factory push pin on the underside of the fender.
6. Loosely install the mud flap and washer plate through holes #1 to #6 to the inner fender through holes # 8 to #10 using (3) sheet metal screws and (3) aluminum washers.
7. With a square or other levelling tool, ensure that the flap is level.
8. Carefully tighten all screws and double-check that the flap has remained level.
9. With a ¼" drill bit, drill through the inner mud flap hole #7 and through the plastic liner #11.
10. Install a machine screw through mud flap hole #7 into inner liner hole #11 using (2) stainless steel washers, (1) lock washer, and (1) hex nut.
11. Repeat procedure for the passenger side.

Diagram #1

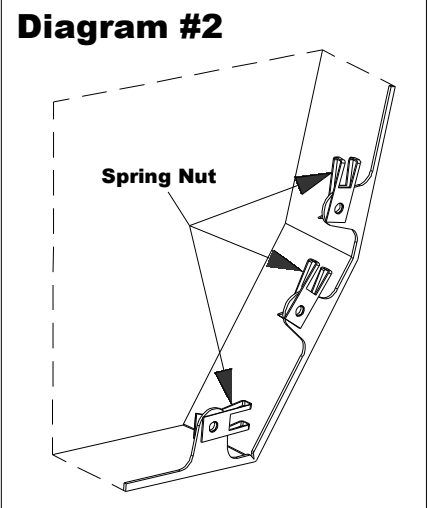
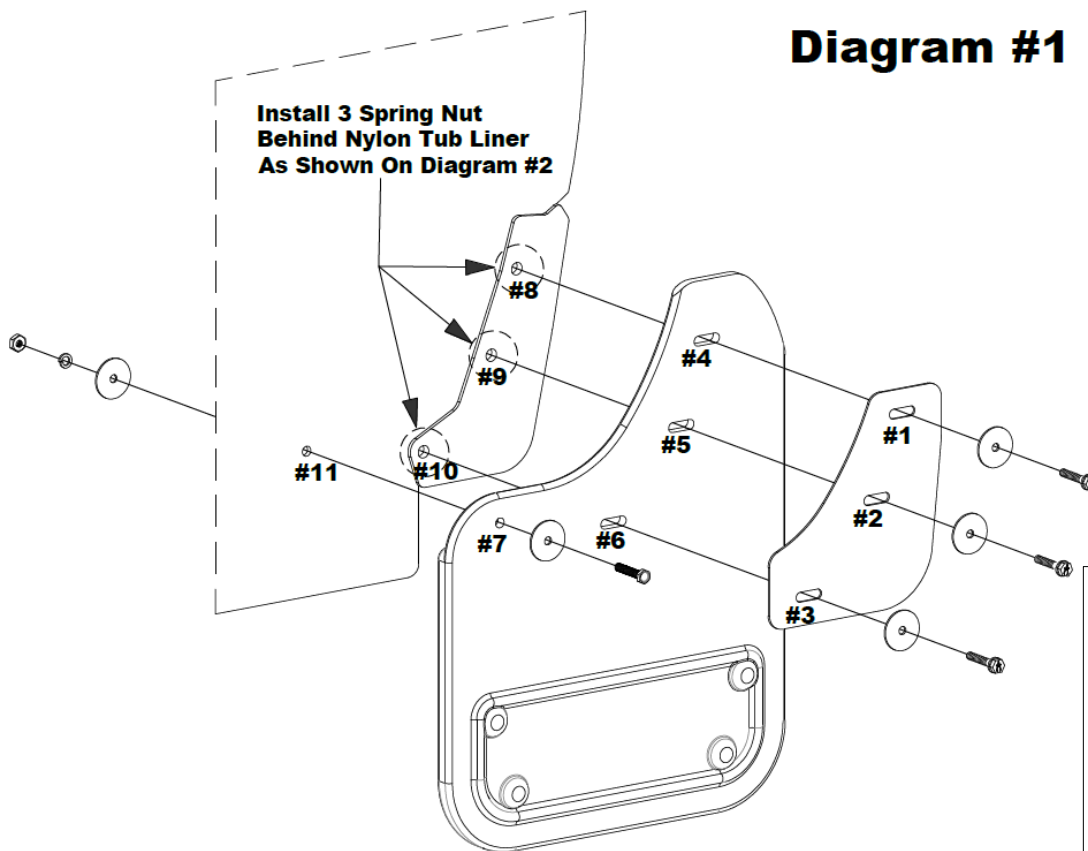

Please check out our YouTube channel to see an install video for this application.





2015-2018 Ford Edge
Mud Flap Set, Rear
Mounting Diagram & Instructions
GCR43R
766627 / 766538 / 766633 / 766639

IMPORTANT:

Manufacturer is not responsible for negligent use of vehicle with mud flaps installed, including over-tightening of screws and bolts causing damage to vehicle or mud flaps.

NO-DRILL SYSTEM

TOOLS REQUIRED-

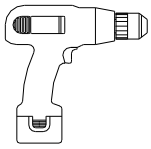

*Electric or re-chargeable
Drill*



1/4" Drill Bit

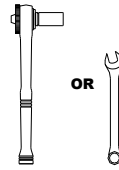

Socket or Open Wrench



Phillips Screw Driver

FLAPS

*(1) Flap Assembly,
Front, DS
Part #766543*

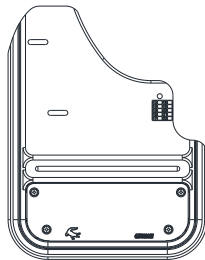

*(1) Flap Assembly
Front, PS
Part #766544*

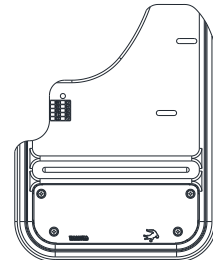

PARTS BAG # 766550

*a) (2) Screw, Machine
SS, #18-8, 10-24 x 1" Hex
Part #012022*



*b) (8) Washer, Flat
0.203" x 1" 18g SS
Part #018031*



*c) (2) Washer, Lock
18-8SS, 10 Helicoil
Part #024001*



*d) (2) Nut, Hex
SS, #10-24
Part #025003*

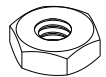

INSTALLATION *(For ease of installation it is suggested that the wheel be removed)*

1. Before you install your Mud Flap Set, see the diagram and parts list for all necessary parts. Start on the driver's side.
2. Remove the factory screws on the inner fender.
3. Loosely install the mud flap through holes #1 & #2 into the factory holes #4 & #5 using (2) factory screws and (2) stainless steel washers. (See Diagram)



- 4. With a square or other levelling tool, ensure that the flap is level.
- 5. Carefully tighten all screws and double-check that the flap has remained level.
- 6. With a 1/4" drill bit, drill through the inner mud flap hole #3 and through the plastic liner #6.
- 7. Install a stainless steel bolt through the inner mud flap hole #3 into the inner liner hole #6 using (2) stainless steel washers, (1) lock washer, and (1) hex nut. (See Diagram)
- 8. Repeat the procedure on the passenger side.

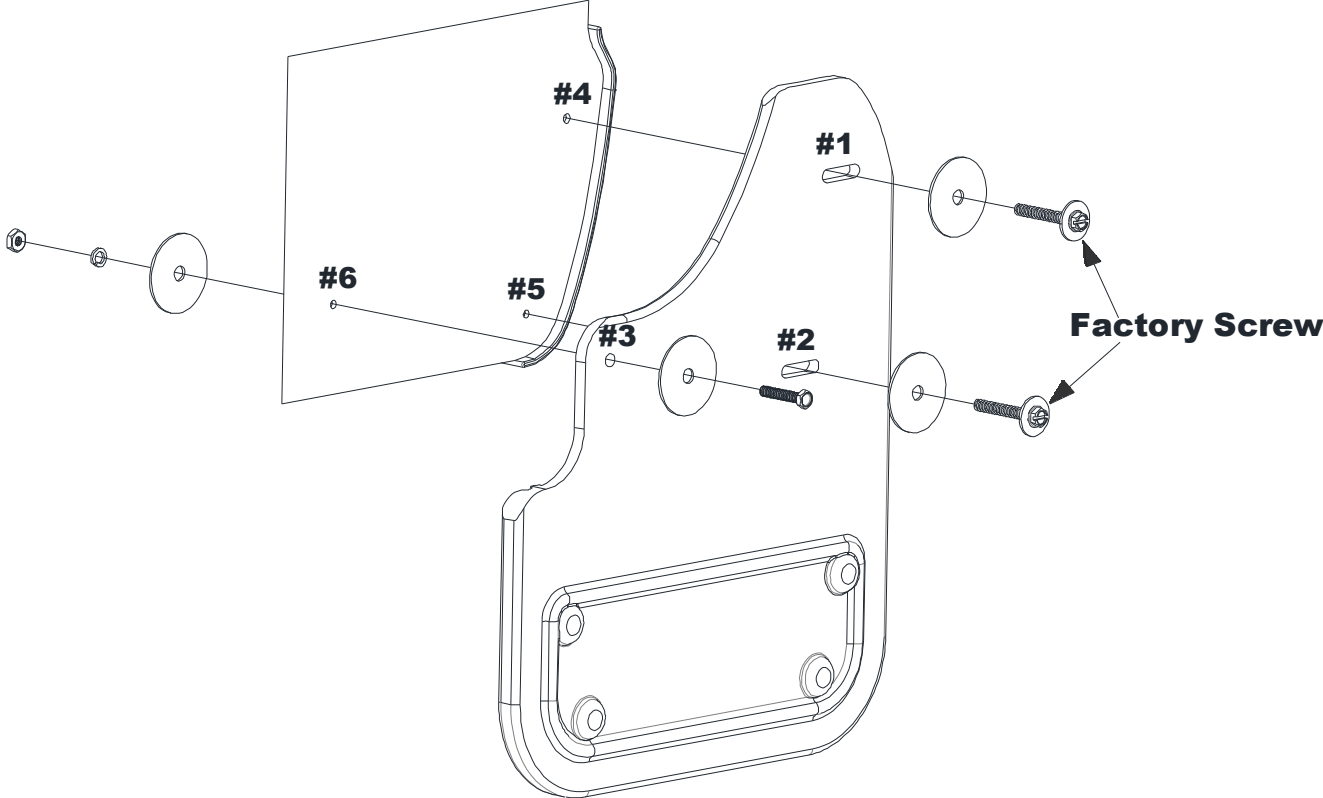

Please check out our YouTube channel to see an install video for this application.

