



AUTOMOTIVE PRODUCTS,

INSTALLATION INSTRUCTIONS

SPORTSMAN GRILLE GUARD, HDX GRILLE GUARD

APPLICATION:

2005-2017 Toyota Tacoma

PART NUMBER:

40-1605, 45-1600, 40-3885, 45-3880, 57-3885

ITEM	QUANTITY	DESCRIPTION	TOOLS NEEDED
1	1	SPORTSMAN GRILLE GUARD / HDX GRILLE GUARD	16MM SOCKET
2,3	2	MOUNTING BRACKET, DRIVER(2) AND PASSENGER(3)	18MM SOCKET
4,5	2	SUPPORT STRAP, DRIVER(4) AND PASSENGER(5)	5MM ALLEN KEY
6	2	M10 BOLT PLATE	14MM SOCKET
7	8	M10 HEX SOCKET BUTTON HEAD BOLT (BLACK ZINC OR RAW) S/S	RATCHET
8	8	M10 FLAT WASHER (BLACK ZINC OR RAW) S/S	TORQUE WRENCH
9	8	M10 SERRATED FLANGE NUT (BLACK ZINC OR RAW) S/S	
10	2	M10 HEX HEAD BOLT (YELLOW ZINC)	
11	2	LARGE M10 FLAT WASHER (YELLOW ZINC)	HARDWARE USED FOR 2016 TOYOTA TACOMA SPORTSMAN & HDX GRILLE GUARD (ITEMS 7 - 17)
12	4	SMALL M10 FLAT WASHER (YELLOW ZINC)	
13	4	M10 SPLIT LOCK WASHER (YELLOW ZINC)	
14	4	M10 HEX NUT (YELLOW ZINC)	
15	2	M12 FLAT WASHER (YELLOW ZINC)	
16	4	M10 POLY RETAINER	
17	1	M10 FISH WIRE	
18	2	M10 SOCKET BUTTON HEAD BOLT (BLACK ZINC OR RAW) S/S	HARDWARE USED FOR 2005-2015 TOYOTA TACOMA SPORTSMAN GRILLE GUARD (ITEMS 18 - 27)
19	4	M10 FLAT WASHER (BLACK ZINC OR RAW) S/S	
20	2	M10 SPLIT LOCK WASHER (BLACK ZINC OR RAW) S/S	
21	2	M10 HEX NUT (BLACK ZINC OR RAW) S/S	
22	6	SHORT M12 HEX HEAD CAP SCREW (YELLOW ZINC)	
23	16	M12 FLAT WASHERS (YELLOW ZINC)	
24	8	M12 HEX NYLOCK NUTS (YELLOW ZINC)	
25	2	LONG M12 HEX HEAD CAP SCREW (YELLOW ZINC)	
26	2	M10 HEX NYLOCK NUTS (YELLOW ZINC)	
27	2	M10 FLAT WASHERS (YELLOW ZINC)	
ANTI-SEIZE LUBRICANT MUST BE USED ON ALL STAINLESS STEEL FASTENERS TO PREVENT THREAD DAMAGE AND GALLING			



Westin Automotive Products, Inc.
320 W. Covina Blvd
San Dimas, Ca. 91773

Thank you for choosing Westin products
for additional installation assistance please call
Customer Service (800) 793-7846
www.westinautomotive.com

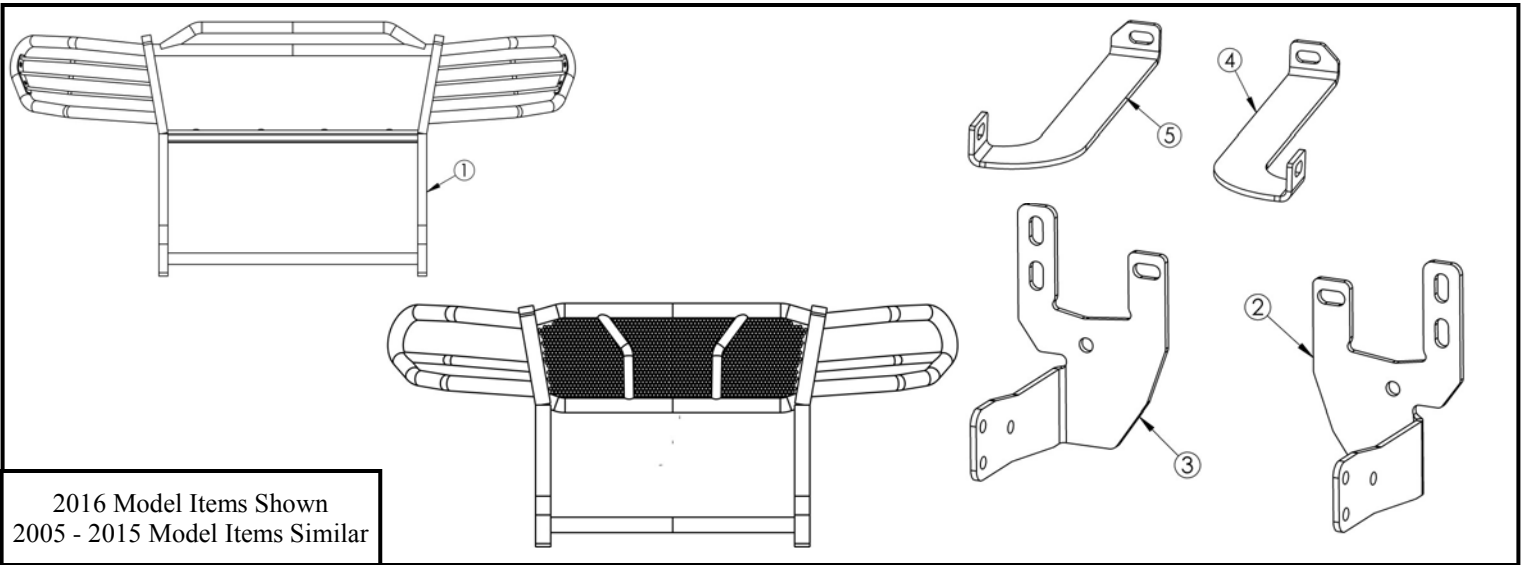

PROCEDURE

1. Remove contents from box, verify if all parts listed are present and free from damage. Carefully read and understand all instructions before attempting installation.
Failure to identify damage before installation could lead to a rejection of any claim.
2. Starting on the front side of the vehicle, from underneath vehicle, remove the three factory nuts that hold the bumper support frame to the vehicle frame. See **Figure 1**. **Note:** Lower valance trimming is required on 2016+ vehicles.
3. **For 2016 vehicles:** Attach the upper holes on the driver side mounting bracket with existing factory nuts. To attach the lower hole on the mounting bracket use the provided (1) M10 hex head bolt, (1) M10 hex nut, (1) M10 plastic retainer, (1) large M10 flat washer, (1) small M10 flat washers and (1) M12 flat washer. Insert the hex head bolt with the large M10 flat washer through the frame and use the M12 washer as a spacer between the frame and mounting bracket. Use the M10 plastic retainer to hold the M12 flat washer in place then attach the mounting bracket. M10 plastic retainer is to secure both the M10 hex head bolt and M12 flat washer in place. See **Figure 2** and **Sportsman Grille Guard Assembly**.
4. **For 2005-2015 vehicles:** Attach the upper holes on the driver side mounting bracket with existing factory nuts. To attach the lower hole on the mounting bracket use the provided (1) long M12 hex head bolt, (1) M12 nylock nut, and (2) M12 flat washers. See **Figure 2**. Refer to **2005 - 2015 Mounting Bracket Assembly**.
5. Repeat steps 2 - 4 for the other side.

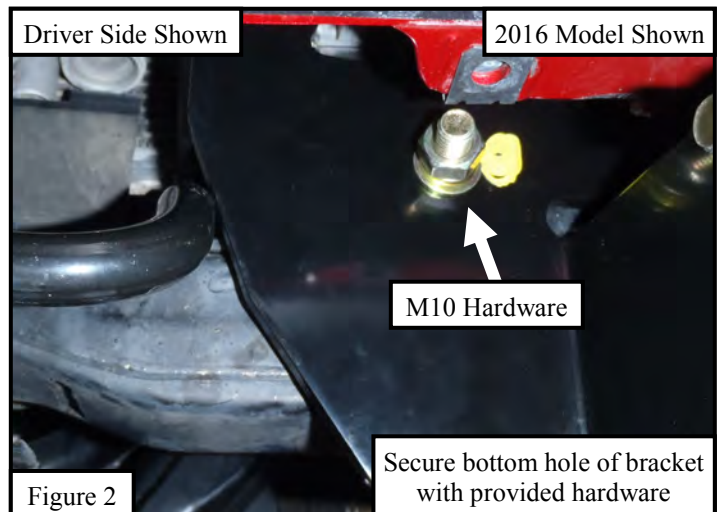
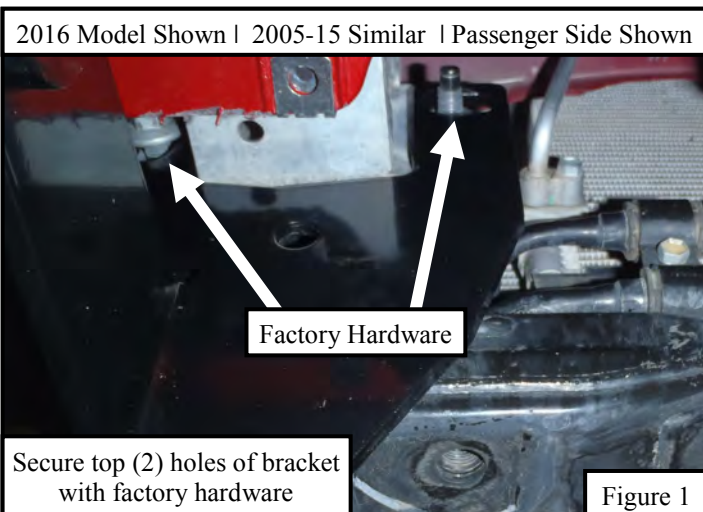

Westin Automotive Products, Inc.
 320 W. Covina Blvd
 San Dimas, Ca. 91773

Thank you for choosing Westin products
 for additional installation assistance please call
 Customer Service (800) 793-7846
www.westinautomotive.com

2005 - 2015 Mounting Bracket Assembly

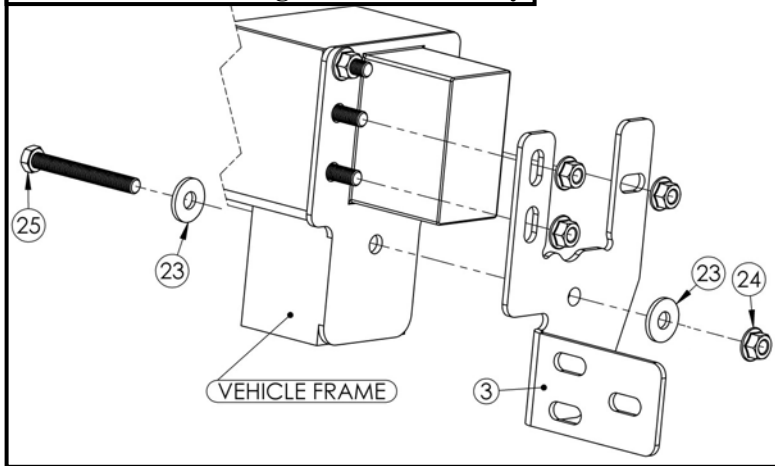

Secure bolt plate using M10 plastic retainer

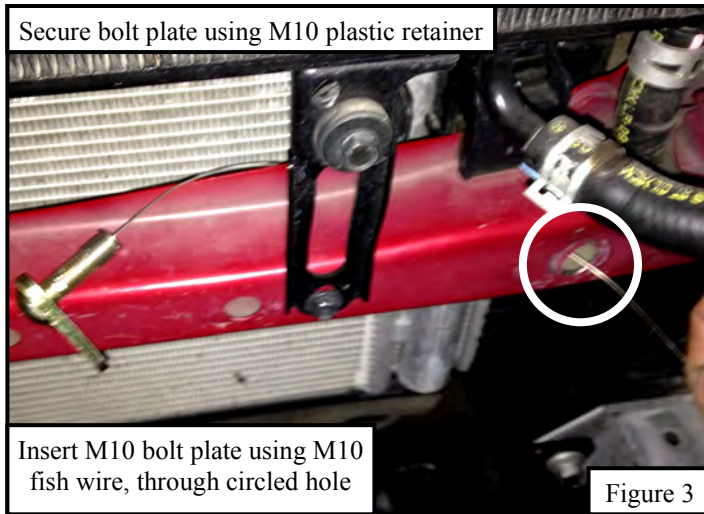
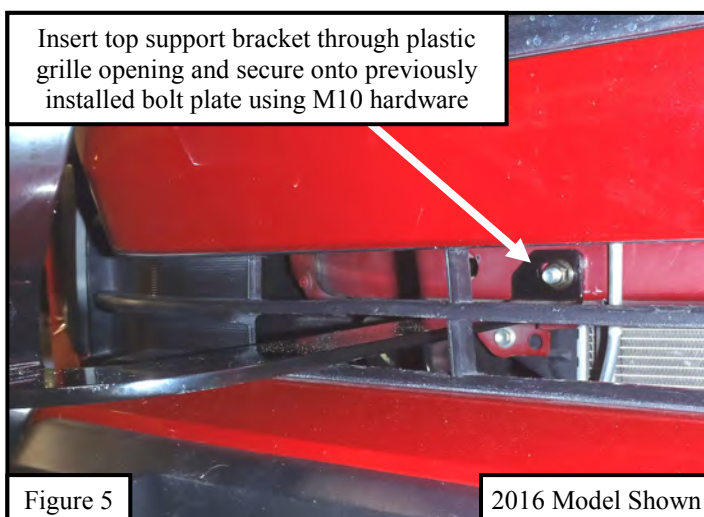
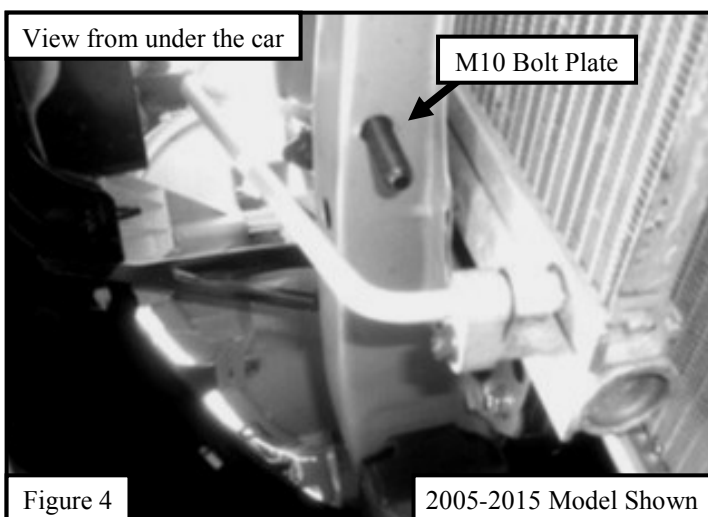

Figure 3

6. **For 2016 vehicles:** Locate one factory hole on each side of the radiator for support, then insert (1) M10 bolt plate into the hole with the help of the M10 fish wire to each side of vehicle. Insert (1) M10 plastic retainer to secure bolt plate in place. See **Figure 3**. Refer to **Sportsman Grille Guard Assembly**.
7. **For 2005-2015 vehicles:** Locate one factory hole on each side of the radiator for support, then insert from the top of the radiator support (1) M10 bolt plate into each hole. See **Figure 4**.
8. **For 2016 vehicles:** Slide the driver side support strap through the plastic grille opening. Attach the inner mounting location of the support strap to the previously inserted bolt plate using the included (1) small M10 flat washer, (1) M10 hex nut and (1) M10 split lock washer nut. See **Figure 5**. Assemble loosely. Refer to **Sportsman Grille Guard Assembly**.



9. **For 2005-2015 vehicles:** Slide the driver side top bracket through the plastic grille opening with 90° bend towards the front and side of the vehicle. See **Figure 6**. Attach the inner mounting location of the support strap to the previously inserted bolt plate using the included (1) M10 flat washer and (1) M10 nylock nut. See **Figure 7**. Assemble loosely.
10. Repeat steps 6 - 9 for the other side.



Westin Automotive Products, Inc.
320 W. Covina Blvd
San Dimas, Ca. 91773

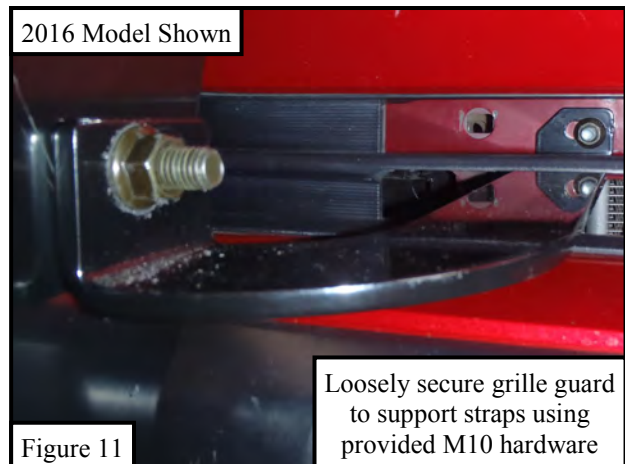
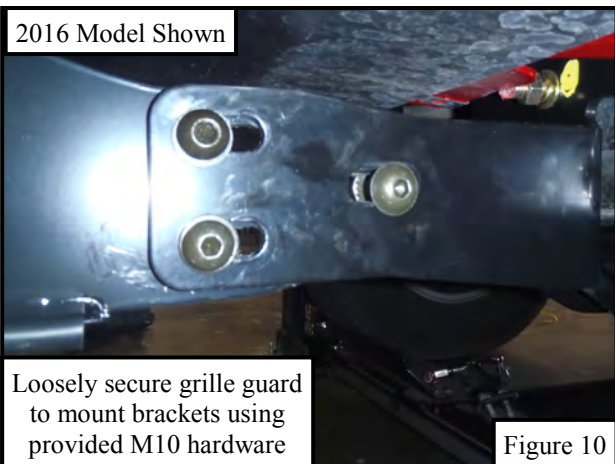
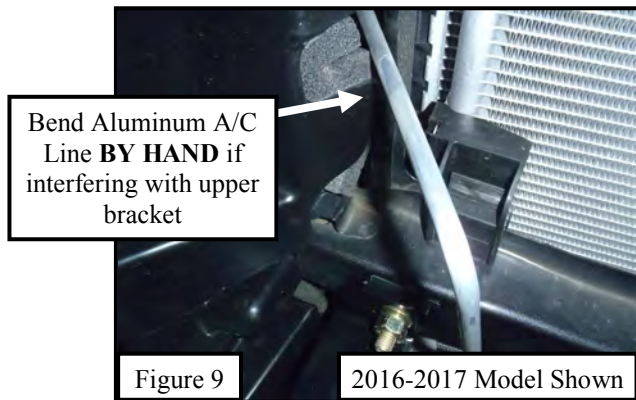
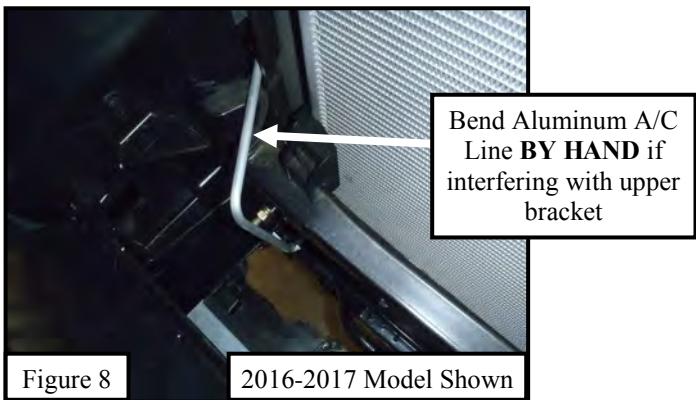
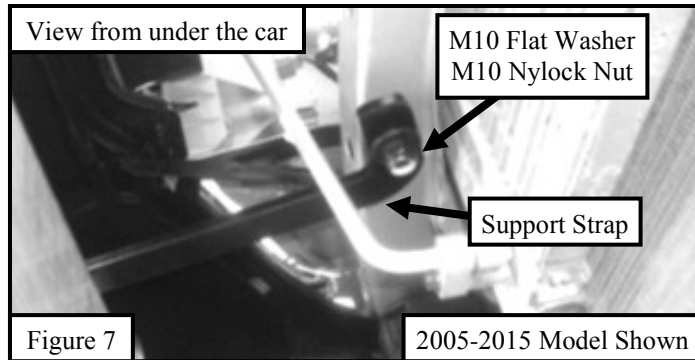
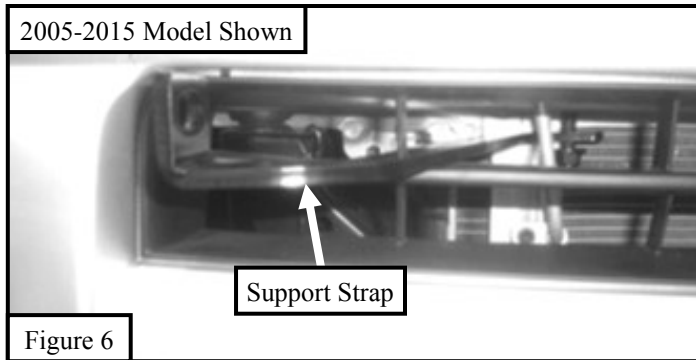

11. **For 2016 vehicles:** Using an assistant position the Grille Guard on the inside of Mounting Brackets and the Support Straps. Use the included (8) M10 head socket button bolts, (8) M10 flat washers and (8) M10 serrated flange nuts. Assemble loosely. See **Figures 8** and **Figure 9**. Refer to **Sportsman Grille Guard Assembly**.
12. **For 2005-2015 vehicles:** With help position the grille guard on the inside of the mounting brackets. Use the provided (6) short M12 hex head bolts, (6) M12 nylock nuts, and (12) M12 flat washers to loosely attach grille guard to mounting brackets. Proceed to loosely attach the support straps on the inner edge of the grille guard using the provided (2) M10 button head bolts, (4) M10 flat washers, (2) M10 lock washers and (2) M10 hex nuts. Assemble loosely. See **Figure 10** and **Figure 11** for reference since 2005-2015 models are similar to 2016 model.
13. Align and adjust the grille guard as necessary then tighten and torque all fasteners as follows: M10 to 25-30 ft-lbs, M12 to 45-50 ft-lbs.

CARE INSTRUCTIONS

- REGULAR WAXING IS RECOMMENDED. DO NOT USE ANY TYPE OF POLISH OR WAX THAT MAY CONTAIN ABRASIVES.
- STAINLESS STEEL PRODUCTS CAN BE CLEANED WITH MILD SOAP AND WATER. STAINLESS STEEL POLISH SHOULD BE USED TO POLISH SMALL SCRATCHES.
- GLOSS BLACK FINISHES SHOULD BE CLEANED WITH MILD SOAP AND WATER.



Westin Automotive Products, Inc.
320 W. Covina Blvd
San Dimas, Ca. 91773

Thank you for choosing Westin products
for additional installation assistance please call
Customer Service (800) 793-7846
www.westinautomotive.com

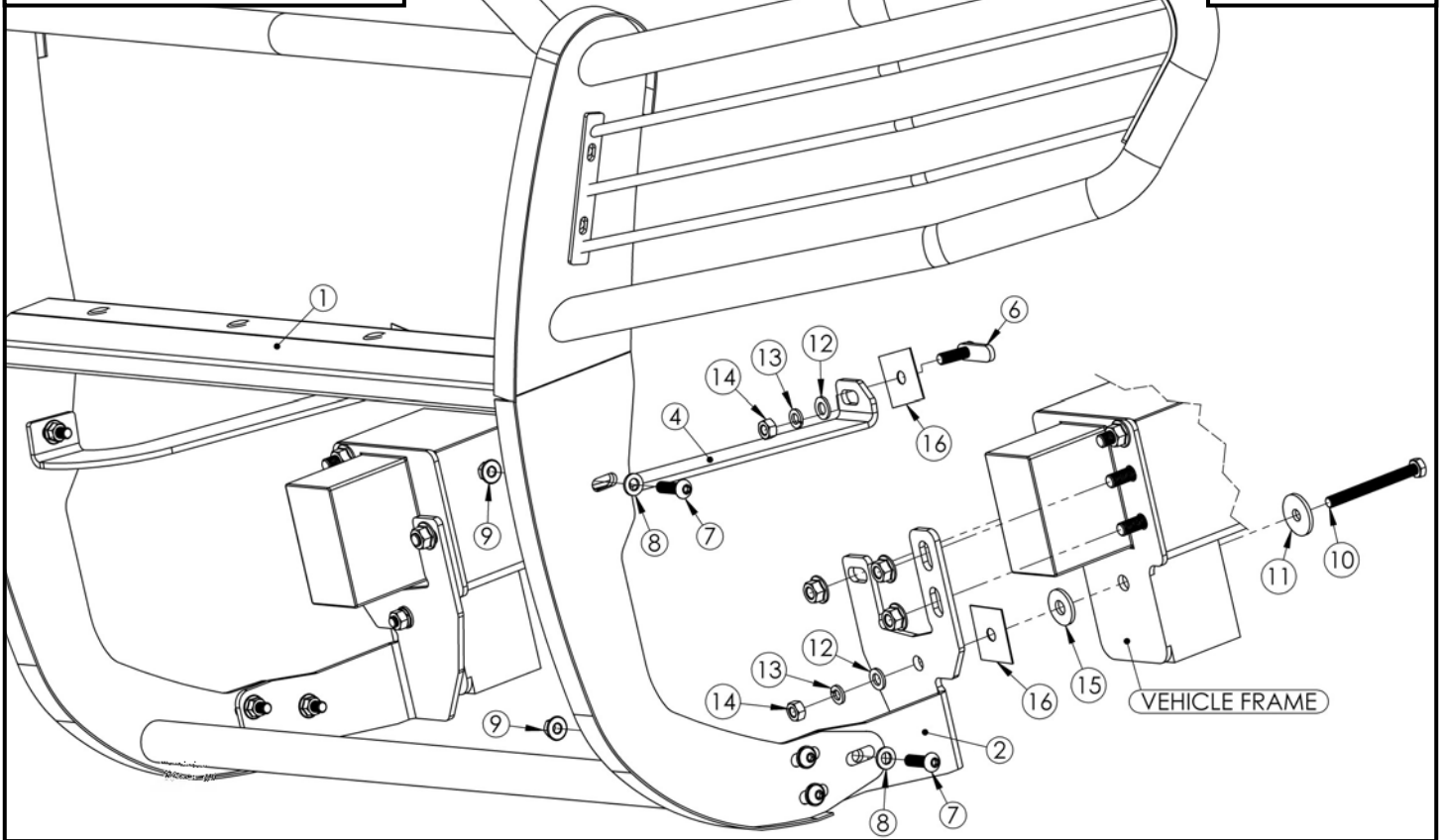
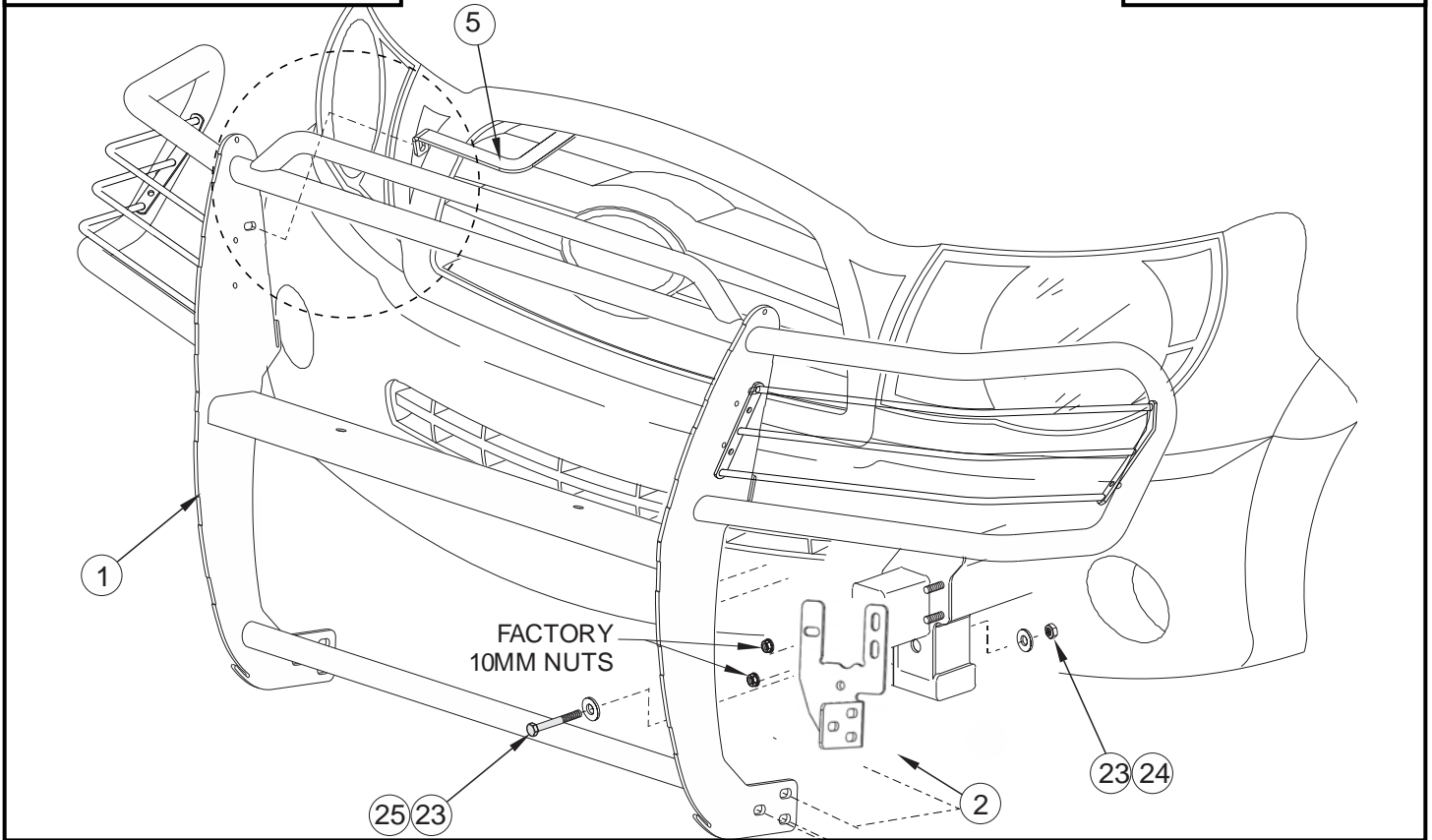

Westin Automotive Products, Inc.
320 W. Covina Blvd
San Dimas, Ca. 91773

Thank you for choosing Westin products
for additional installation assistance please call
Customer Service (800) 793-7846
www.westinautomotive.com



INSTALLATION COMPLETE

2005-2015 Model Shown



INSTALLATION COMPLETE

2016 Model
SPORTSMAN
GRILLE GUARD
Shown



Westin Automotive Products, Inc.
320 W. Covina Blvd
San Dimas, Ca. 91773

Thank you for choosing Westin products
for additional installation assistance please call
Customer Service (800) 793-7846
www.westinautomotive.com



INSTALLATION COMPLETE

2016 Model HDX
GRILLE GUARD
Shown



Westin Automotive Products, Inc.
320 W. Covina Blvd
San Dimas, Ca. 91773

Thank you for choosing Westin products
for additional installation assistance please call
Customer Service (800) 793-7846
www.westinautomotive.com



SIGNATURE OF QUALITY

AUTOMOTIVE PRODUCTS, INC.



WARNING



Failure to follow these instructions could lead to death, personal injury, and / or property damage.

FASTENERS:

All Westin supplied fasteners must be utilized and installed in accordance with the installation instructions and apply torque to the specifications as defined. **DOUBLE CHECK ALL FASTENERS BEFORE INITIAL USE, AND PERIODICALLY IN THE FUTURE TO ENSURE PROPER FUNCTION AND SAFETY.**

DRILLING:

Most Westin products do not require drilling for installation. If drilling is defined as required, use caution when drilling a vehicle. **FAILURE TO REVIEW AN AREA TO BE DRILLED MAY RESULT IN PERSONAL INJURY AND/OR INJURY TO OTHERS AS WELL AS VEHICLE DAMAGE.**

EYE PROTECTION:

ALWAYS WEAR SAFETY GLASSES OR GOGGLES DURING THE INSTALLATION PROCESS TO AVOID PERSONAL INJURY.

MAXIMUM TOWING/CARRYING CAPACITY:

The Westin Receiver Hitches will have a visible tow rating label affixed directly on the product. User should never exceed the vehicle manufacturers maximum tow and weight rating regardless of the capacity of the hitch. **FAILURE TO FOLLOW THESE GUIDELINES WILL VOID THE WESTIN WARRANTY AND MAY RESULT IN PERSONAL INJURY AND/OR INJURY TO OTHERS AS WELL AS VEHICLE DAMAGE.**



Westin Automotive Products, Inc.
320 W. Covina Blvd
San Dimas, Ca. 91773