



GMC Sierra
2014-2018, 1500 & 2015-2019, HD
Rear Mounting Brackets
Mounting Diagram & Instructions
GB756802

IMPORTANT:

Manufacturer is not responsible for negligent use of vehicle with mud flaps installed, including over-tightening of screws and bolts causing damage to vehicle or mud flaps.

TOOLS REQUIRED:

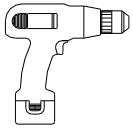

*Electric or Rechargeable
1/2" or 3/8" Drill*



*#15 Torque
Screwdriver*

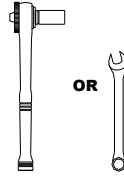

*7/16" Open Wrench
or Socket Wrench*

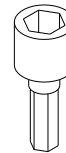

3/8" Socket Driver



*#2 Phillips
Screwdriver*

KIT CONTAINS:

*(1) Upper Mount
Rear, DS
Part #755839*

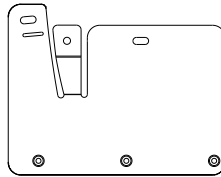

*(1) Upper Mount
Rear, PS
Part #755840*

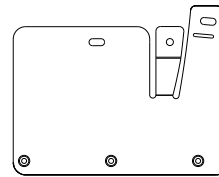

PARTS BAG #755834

*a) (6) Machine Screw
#8-32 x 0.875"
Part #012025*



*b) (2) Tek Screw
1/4" x 1-1/4"
Part #010011*



*c) (2) Capscrew
0.25"-20 x 1"
Part #014007*



*d) (6) Nylock Nut
#8-32
Part #025005*



*e) (4) Flat Washer
0.281" x 1"
Part #018028*

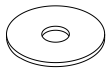

*f) (6) Flat Washer
0.188" x 0.781"
Part #018018*



*g) (1) Mount Clip
DS, Clinch Nut
Part #750582*

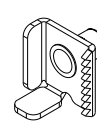

*h) (1) Mount Clip
PS, Clinch Nut
Part #750584*

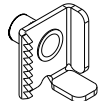

INSTALLATION:

1. Before you install your mud flap set, see the diagram, templates, and parts list for all necessary parts. Cut protective plastic and peel away from stainless steel. Start on the driver's side.
2. Install upper mount on mud flap, ensuring that the lower dimples on the rubber are utilized as shown in Diagram #1. Secure using (3) machine screws #012025, (3) flat washers #018018, and (3) nylock nuts #025005.
3. Install the mud flap clip to hole #1 with a capscrew #014007 and a flat washer #018028. Tighten screw until the bottom tab of the mud flap clip just passes through the bottom slotted hole of hole #1 as shown in Diagram #2.
4. Remove the factory screw on the wheel tub as shown on the diagram and reinstall factory screw on hole #3 through the factory hole #4 as shown in Diagram #2. Loosely secure at this point. Ensure the installed mud flap clip is behind the factory wheel well.
5. Square the flap with the tire while putting pressure against the wheel well and tighten the factory screw on hole #3 as shown in Diagram #2.
6. Now secure the flap with a flat washer #018028 and a self-tapping tek screw #010011 on hole #2 through the wheel tub as shown in Diagram #2.
7. Secure the upper tab of the mud flap by sliding the installed mud flap clip on hole #1 to the wheel well until mud flap clips teeth are gripping behind the wheel well, then tighten the screw.
8. Check all fasteners for tightness. Repeat procedure for passenger side.



Diagram #1

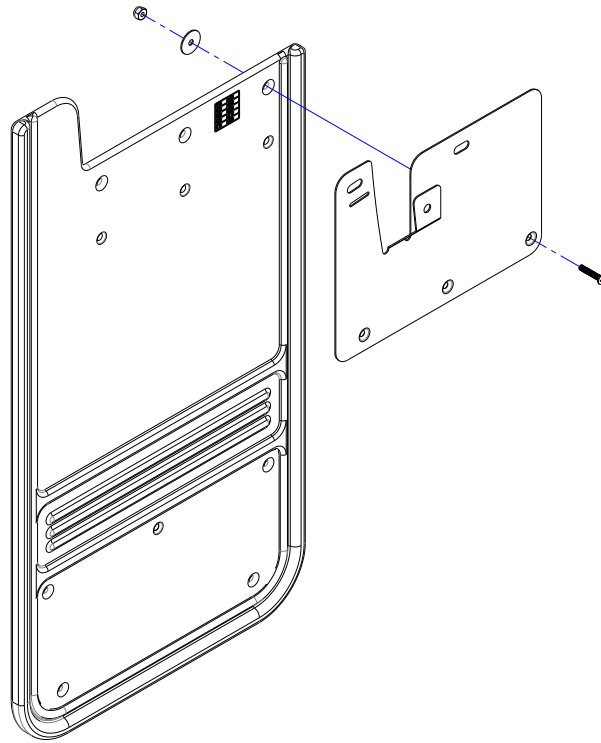
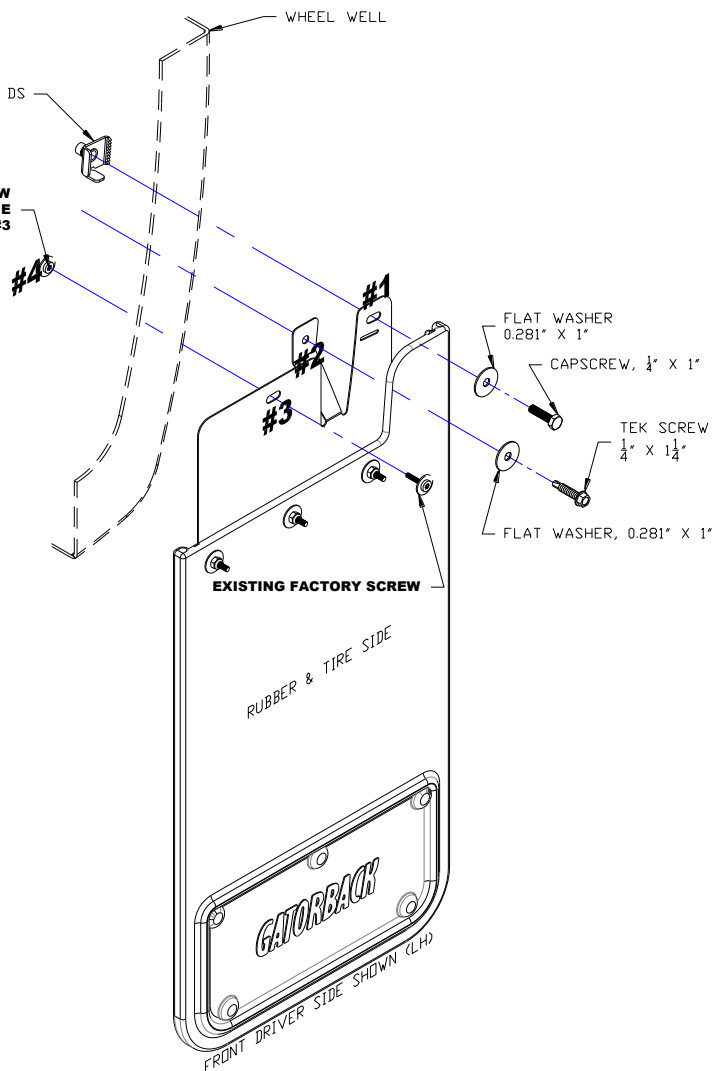

Diagram #2

**REMOVE THE FACTORY SCREW
AND REINSTALL THROUGH THE
STAINLESSSTEEL PANEL HOLE #3**



PLEASE NOTE:
These instructions are for the
installation of the bracket
only.

Use self-tapping screws and
stainless steel washers
provided with your mud flap
kit to drill in and secure the
mud flaps to the wheel well
lip. Failure to do so will result
in the voiding of any
warranty.