

# Installation Instructions

I - Sheet Number BF29 Rev.A



AUTO VENT SHADE™

## Bugflector® - Bugflector II® - Carflector®

For proper installation and best possible fit, please read all instructions BEFORE you begin.  
For technical assistance or to obtain missing parts, please call Customer Relations at 1-800-241-7219.

### Important Safety Information



- CAUTION - Before driving, ensure that the hood shield is properly secured to vehicle.
- Do not use automatic "brush-style" car washes.
- Do not use cleaning solvents of any kind.
- Periodically check all components for tightness.

### Contents

**NOTE:** Actual product may vary from illustration.

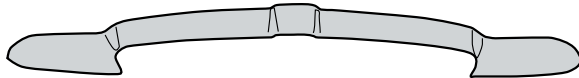

Hood shield



Bump On  
x4



Alcohol  
Pad x2

### Tools Required



Car Wash Supplies

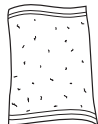

Clean Towel

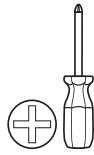

Phillips  
screwdriver

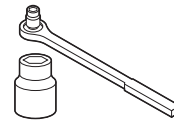

Socket  
wrench

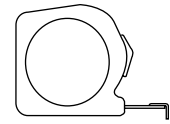

Tape measure

### Preparation Before Painting / Installation

- A trial fit is recommended to ensure proper positioning and fit.
- Check fit of parts before painting as we will not accept the return of modified or painted parts.
- Wash and dry your vehicle to remove any debris and/or dirt from the installation area.

### Installation Steps

**NOTE:** Actual application may vary slightly from illustrations.

Open hood.

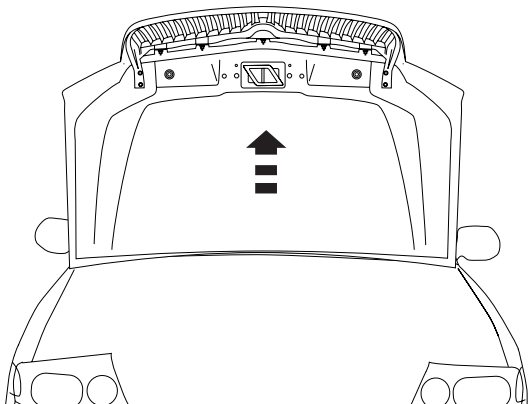

1

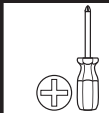

Loosen (5) nuts and (4) screws that attach grill to hood.

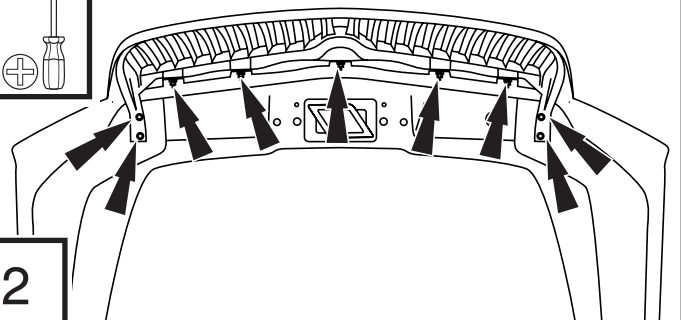

2

# Installation Steps

**NOTE:** Actual application may vary slightly from illustrations.

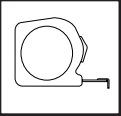

Lower hood, and create a 1/4" (.64 cm) gap between the grill and the hood.

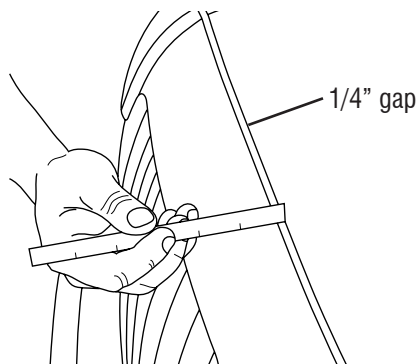

3



Clean the tape mounting locations on both ends of the hood with an alcohol pad.

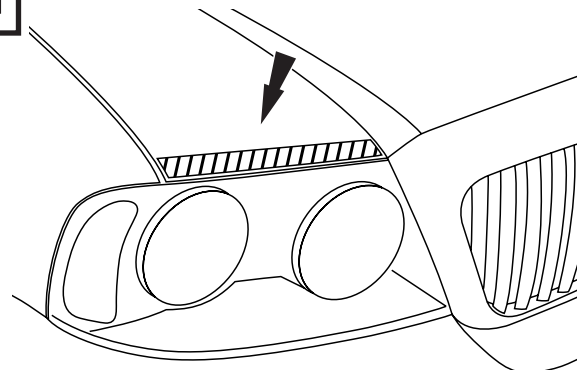

4

Expose 2" (5 cm) of tape liner from each end of the flanges on the hood shield.

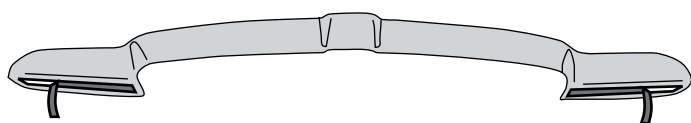

5



Install bump ons at pre-cleaned locations on both sides of the hood and front fenders.

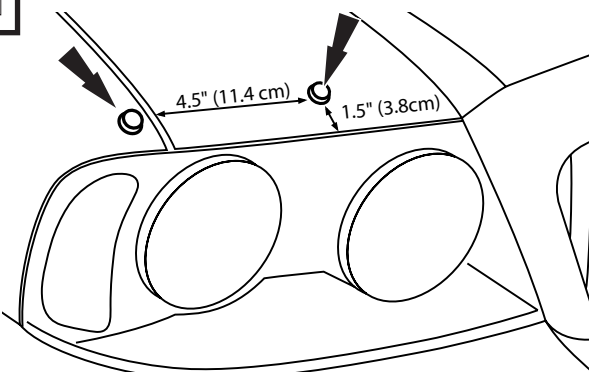

6

Align the hood shield center point with the center of hood. Slide hood shield into created gap between grill and hood. Press on exposed tape to secure position.

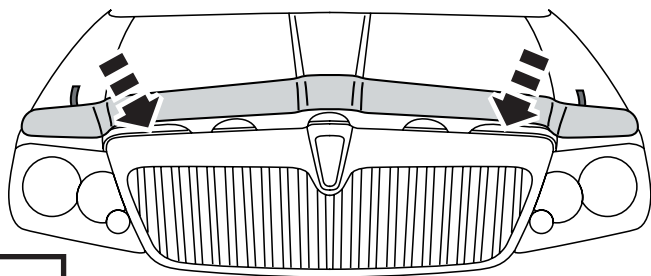

7



Raise hood and retighten the (5) grill nuts and (4) grill screws.

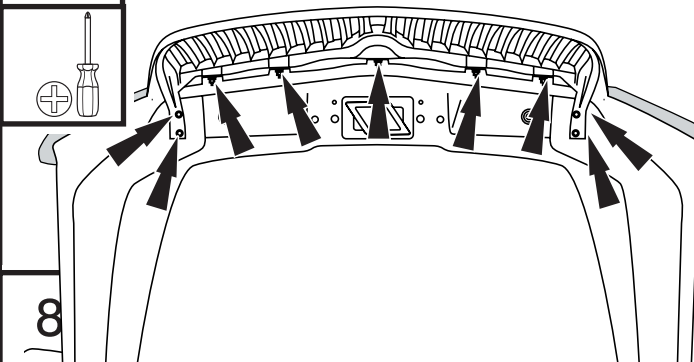

8

With the hood shield in its final position, remove the remaining tape liner by pulling on free ends.

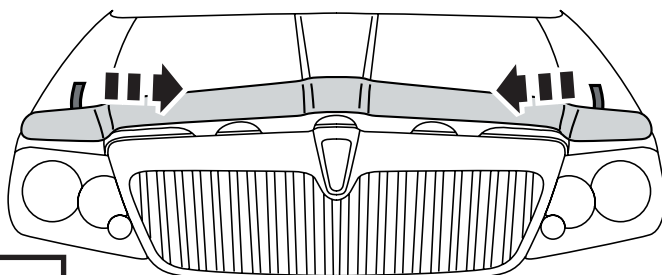

9



Apply pressure to taped areas to ensure adhesion.

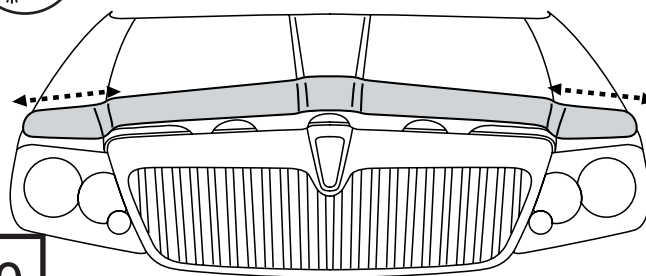

10

## Care and Cleaning

- Wash only with mild soap & dry with a clean cloth.

## Congratulations!

You have purchased one of the many quality Auto Ventshade™ branded products offered by Lund International, Inc. We take the utmost pride in our products and want you to enjoy years of satisfaction from your investment. We have made every effort to ensure that your product is top quality in terms of fit, durability, finish and ease of installation.



AUTO VENTSHADE™

Lund International, Ventshade Accessories Division  
655 Raco Drive, Lawrenceville, GA 30045  
800-241-7219 • Fax 770-339-5839 • Visit us at [lundinternational.com](http://lundinternational.com)



© 2005 Lund International, Inc. All rights reserved.  
Auto Ventshade™, the Auto Ventshade™ logo and the AVS™ logo are trademarks of Lund International, Inc.





## Bugflector® - Bugflector II® - Carflector®

Pour obtenir une installation correcte et le meilleur ajustement possible, lire toutes les instructions AVANT de commencer. Pour toute assistance technique ou obtention de pièces manquantes, appeler le service des relations avec la clientèle au 1-800-241-7219.

### Informations importantes concernant la sécurité



- ATTENTION – Avant de conduire, s'assurer que le pare-insectes est solidement assujettie sur le véhicule.
- Ne pas utiliser les stations de lavage de voitures à brosse.
- Ne pas utiliser de solvants.
- Vérifier régulièrement le serrage des composants.

### Contenu **NOTE:** Le produit réel peut changer de l'illustration.

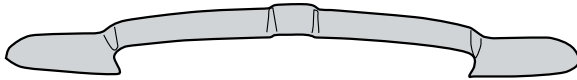

Pare-insectes



Butoirs (4)



Garniture D'Alcool (2)

### Outils nécessaires



Fournitures pour lavage de voiture

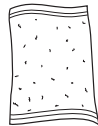

Serviette propre

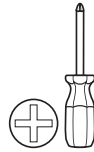

Tournevis Phillips

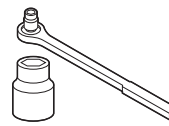

Clé à douille

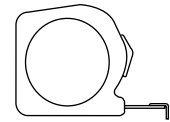

Mesure de bande

### Préparation pour la peinture/l'installation

- Il est recommandé de procéder à un essai pour s'assurer que le positionnement et l'ajustement sont corrects.
- Vérifier l'ajustement des pièces avant peinture, car nous n'acceptons pas le retour de pièces modifiées ou peintes.
- Laver les glissières de glaces de la portière du véhicule pour éliminer toute poussière et tous débris.
- Sécher les glissières avec une serviette propre.

### Étapes d'installation

**REMARQUE :** La méthode d'application peut être légèrement différente de celle représentée par les illustrations.

Ouvrir le capot.

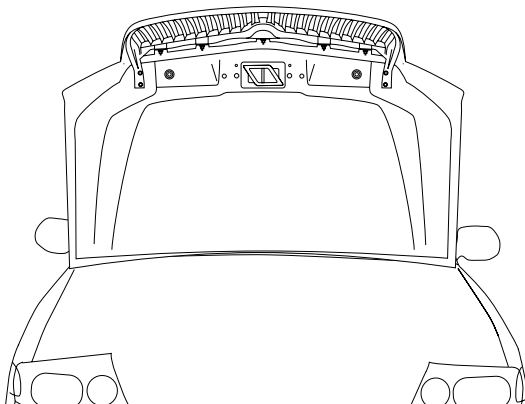

1

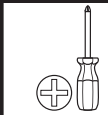

Desserrer les (5) écrous et les (4) vis qui retiennent la calandre au capot.

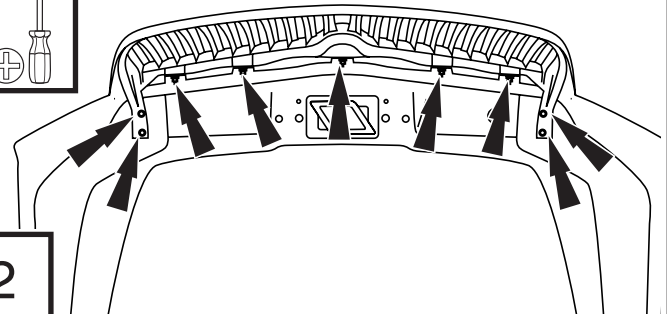

2

# Étapes d'installation

REMARQUE : La méthode d'application peut être légèrement différente de celle représentée par les illustrations.

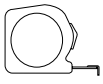

Abaissier le capot et écartier la calandre de 0,64 cm (1/4 po) du capot.

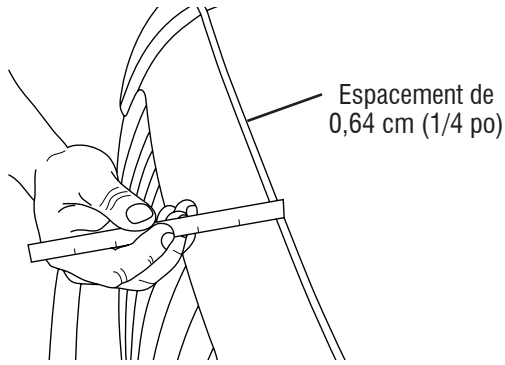

3



À l'aide d'un tampon à l'alcool, nettoyer les surfaces de montage de la bande adhésive à chacune des deux extrémités du capot.

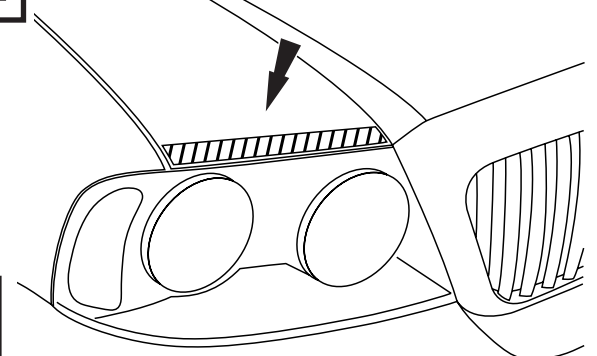

4

Décoller 5 cm (2 po) de protection d'adhésif de chacun des rebords du pare-insectes.

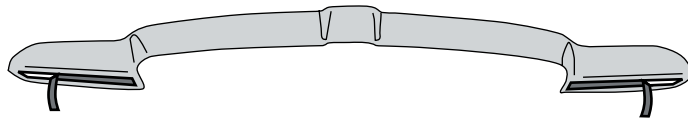

5



Installer les butoirs aux endroits prénettoyés, des deux côtés du capot et des ailes avant.

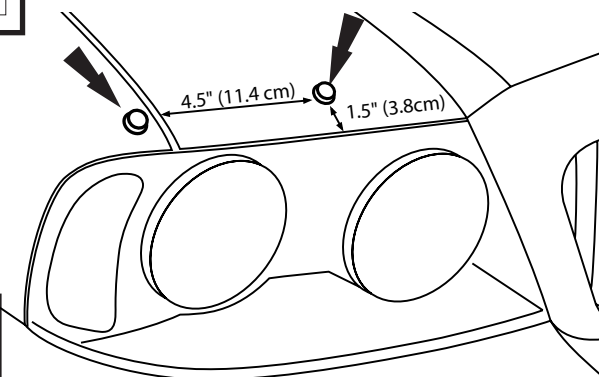

6

Aligner le point central du pare-insectes et le centre du capot. Faire glisser le pare-insectes dans l'écartement créé entre la calandre et le capot. Appuyer sur la partie exposée du ruban adhésif pour le faire adhérer en position.

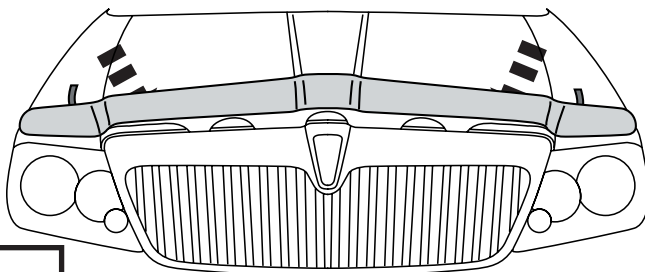

7



Ouvrir le capot et resserrer les (5) écrous et les (4) vis de la calandre.

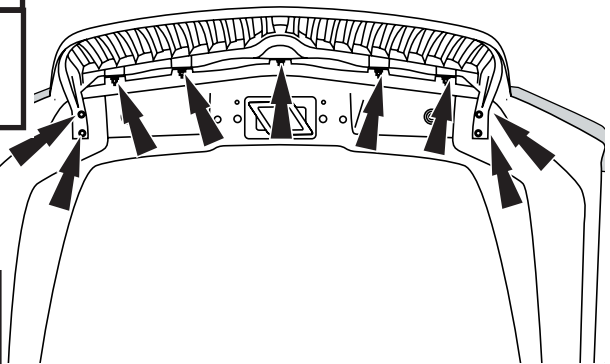
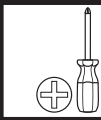

8

Une fois le pare-insectes en position finale, retirer le reste de la protection d'adhésif en tirant sur les extrémités libres.

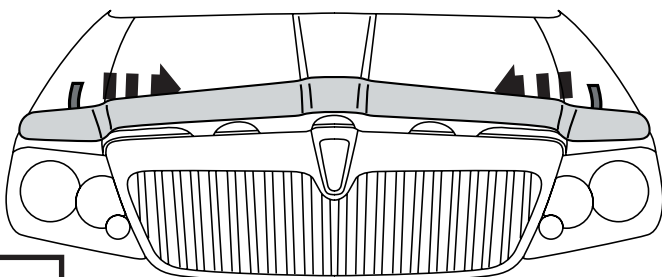

9



Appuyer sur les emplacements collés pour assurer une bonne adhésion.

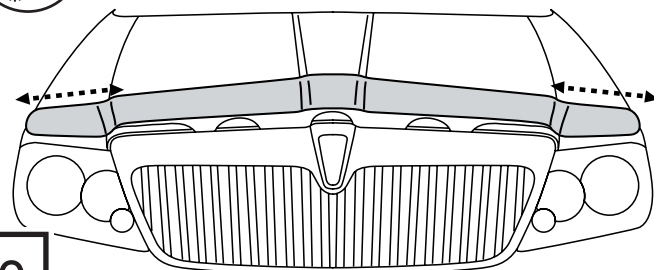

10

## Entretien et nettoyage

- Laver exclusivement avec de l'eau savonneuse et sécher avec un chiffon propre.

## Félicitations !

Vous avez acheté l'un des nombreux produits de qualité Auto Ventshade™ fabriqués par Lund International, Inc. Nous sommes extrêmement fiers de nos produits et souhaitons que vous tiriez des années de satisfaction de votre investissement. Nous avons pris toutes les mesures nécessaires pour assurer que ce produit est d'une qualité supérieure en ce qui concerne l'ajustement, la durabilité, la finition et la facilité d'installation.



**AUTO VENTSHADE™**

Lund International, Ventshade Accessories Division

655 Raco Drive, Lawrenceville, GA 30045, USA

800-241-7219 • Fax 770-339-5839 • Visitez notre site [lundinternational.com](http://lundinternational.com)



© 2005 Lund International, Inc. Tous droits réservés.

Auto Ventshade™, le logo Auto Ventshade™ et le logo AVS™ sont des marques déposées de Lund International, Inc.





## Bugflector® - Bugflector II® - Carflector®

Para una instalación adecuada y el mejor ajuste posible, lea todas las instrucciones ANTES de comenzar. Si desea recibir asistencia técnica u obtener piezas faltantes, llame al Servicio al cliente al 1-800-241-7219.

### Información importante de seguridad



- PRECAUCIÓN - Antes de conducir, asegúrese de que la visera deflectora esté correctamente anclada al vehículo.
- No utilice servicios automáticos de limpieza de vehículos que utilizan cepillos.
- No utilice limpiadores al solvente de ningún tipo.
- Compruebe periódicamente que todos los componentes estén ajustados.

### Contenido

**NOTA:** El producto real puede variar de la ilustración.

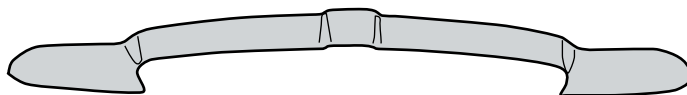

Cubierta para capó



Soporte (2)



Cojín Del Alcohol (2)

### Herramientas necesarias



Equipo de limpieza de vehículos

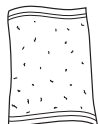

Toalla limpia

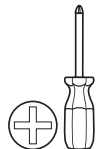

Destornillador Phillips

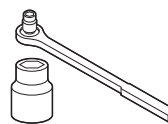

Llave de zócalo

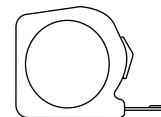

Cinta métrica

### Preparación antes de pintar o instalar

- Se recomienda realizar un ajuste de prueba para asegurar el posicionamiento y ajuste correctos.
- Compruebe que las piezas se ajusten correctamente antes de pintarlas, ya que no aceptaremos la devolución de piezas modificadas o pintadas.
- Lave los canales de la ventanilla del vehículo para quitar los desechos y la suciedad.
- Seque los canales de la ventanilla con una toalla limpia.

### Pasos de instalación

**NOTA:** El uso real puede variar levemente de ilustraciones.

Abra el capó.

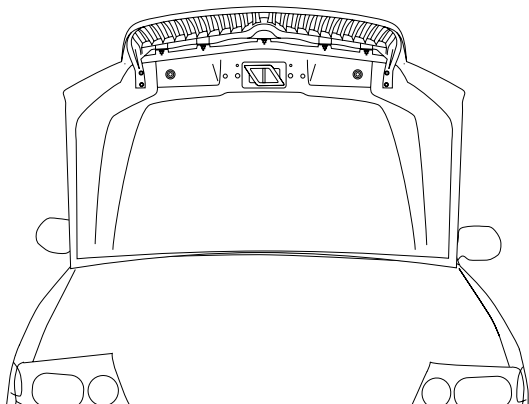

1

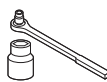

Afloje las (5) tuercas y los (4) tornillos que unen la parrilla al capó.

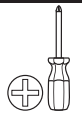

2

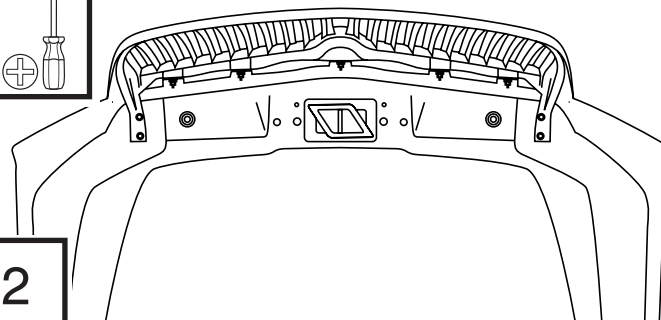

# Pasos de instalación

**NOTA:** El uso real puede variar levemente de ilustraciones.

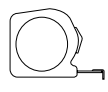

Baje el capó y cree un espacio de 1/4" (0,64 cm) entre la parrilla y el capó.

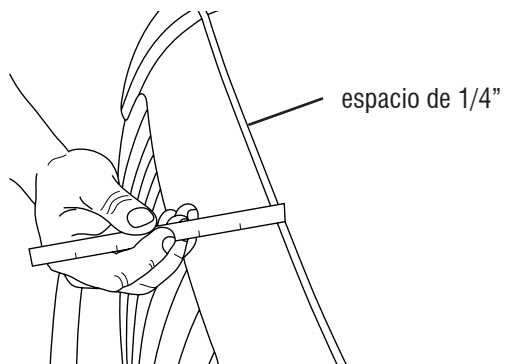

3



Limpie el lugar de colocación en ambos extremos del capó con un paño esterilizado.

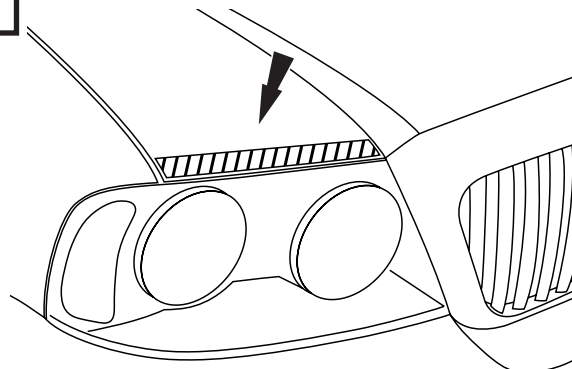

4

Exponga 2" (5 cm) de cinta protectora en cada extremo de los rebordes de la cubierta para capó.

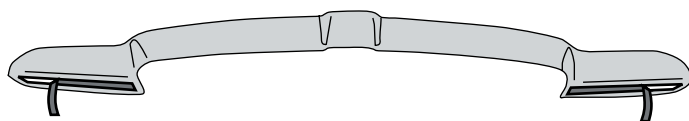

5



Coloque los soportes en las ubicaciones que limpió anteriormente en ambos extremos del capó y los guardabarras delanteros.

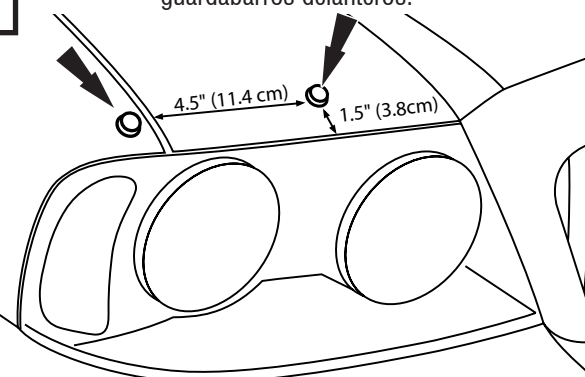

6

Alinee el centro de la cubierta para capó con el centro del capó. Deslice la cubierta para capó en el espacio creado entre la parrilla y el capó. Presione la cinta que quedó expuesta para fijarla.

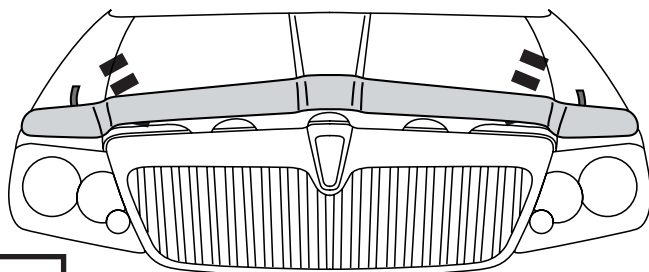

7



Levante el capó y vuelva a ajustar las (5) tuercas y los (4) tornillos de la parrilla.

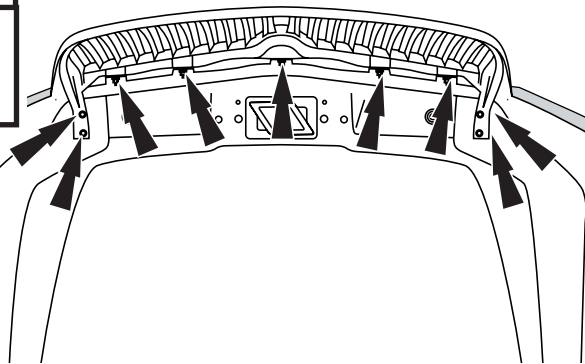

8

Una vez que la cubierta para capó se encuentre en su posición definitiva, quite la cinta protectora restante tirando de los extremos que quedaron libres.

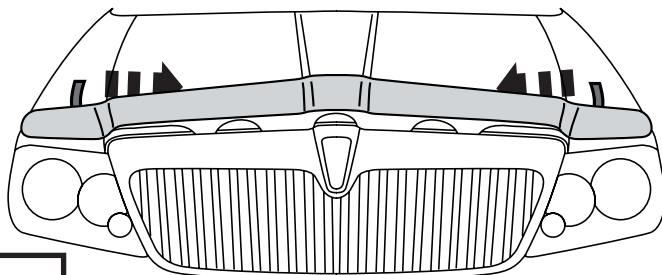

9



Presione en todas las áreas encintadas para asegurar la adhesión.

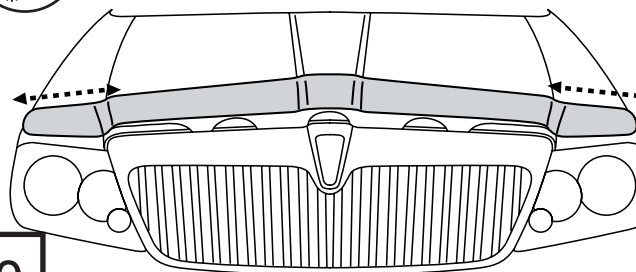

10



## Cuidado y limpieza

- Limpie solamente con agua jabonosa tibia y seque con un paño limpio.

## Felicidades

Usted ha comprado uno de los tantos artículos de calidad de Auto Ventshade™ ofrecidos por Lund International, Inc. Nuestros productos son nuestro mayor orgullo. Deseamos que disfrute de años de satisfacción con su inversión. Hemos realizado todos los esfuerzos para asegurarnos de que su producto sea de la mejor calidad en cuanto a ajuste, durabilidad, acabado y facilidad de instalación.



**AUTO VENTSHADE™**

Lund International, Ventshade Accessories Division

655 Raco Drive, Lawrenceville, GA 30045

800-241-7219 • Fax 770-339-5839 • Visite nuestro sitio Web: [lundinternational.com](http://lundinternational.com)



© 2005 Lund International, Inc. Todos los derechos reservados.

Auto Ventshade™, el logo de Auto Ventshade™ y el logo de AVS™ son marcas comerciales de Lund International, Inc.

