

Installation Instructions

I - Sheet Number BF79 Rev.A



Bugflector® - Bugflector II® - Carflector® - Chrome Hood Shield™

For proper installation and best possible fit, please read all instructions BEFORE you begin.
For technical assistance or to obtain missing parts, please call Customer Relations at 1-800-241-7219.

Important Safety Information



- CAUTION - Before driving, ensure that the hood shield is properly anchored to vehicle.
- Do not use automatic "brush-style" car washes.
- Do not use cleaning solvents of any kind.
- Periodically check all components for tightness.

Contents **NOTE:** Actual product may vary from illustration.



Hood Shield

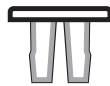

Hood Insert x2



Washer x2



Screw x2

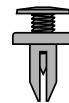

Fastener x2



Bump On x4

Tools Required



Car Wash Supplies

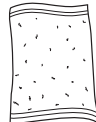

Clean Towel

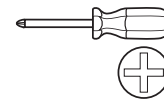

Appropriate hand tools

Preparation Before Painting / Installation

- A trial fit is recommended to ensure proper positioning and fit.
- Check fit of parts before painting as we will not accept the return of modified or painted parts.
- Wash and dry your vehicle to remove any debris and/or dirt from the installation area.

Installation Steps **NOTE:** Actual application may vary slightly from illustrations.

Open Hood.

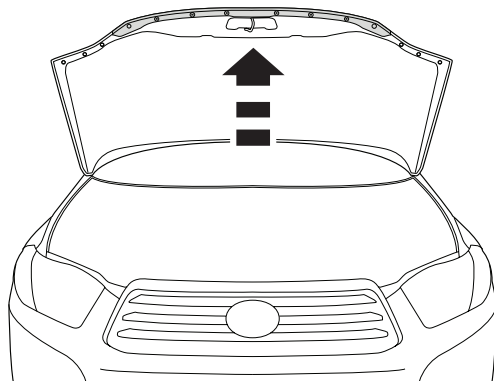

1

Remove (2) weatherstrip retainers.

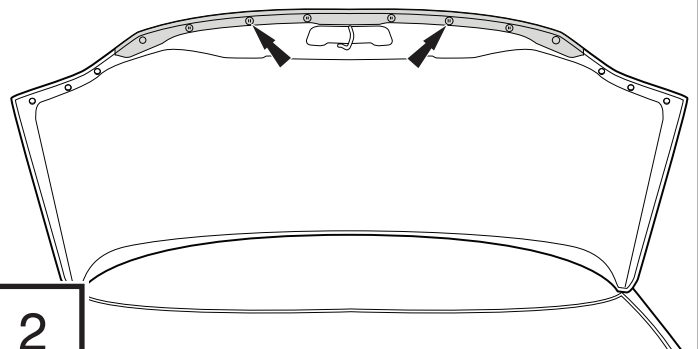

2

Installation Steps

NOTE: Actual application may vary slightly from illustrations.

3 Install (2) hood inserts in hood, **UNDER-NEATH** the weatherstrip.

Center part on front edge of hood and align holes.
NOTE: Inner flanges should be **UNDER** weatherstrip.

4

Install (2) screws with washers on the inner flanges.

5

Install (2) fasteners on the outer flanges.

6

Close hood. Apply bump ons to surface of hood

7

Care and Cleaning

- Wash only with mild soap & dry with a clean cloth.

Congratulations!

You have purchased one of the many quality Auto Ventshade™ branded products offered by Lund International, Inc. We take the utmost pride in our products and want you to enjoy years of satisfaction from your investment. We have made every effort to ensure that your product is top quality in terms of fit, durability, finish and ease of installation.



AUTO VENTSHADE™

Lund International, Ventshade Accessories Division
655 Raco Drive, Lawrenceville, GA 30045

800-241-7219 • Fax 770-339-5839 • Visit us at lundinternational.com

© 2007 Lund International, Inc. All rights reserved.



Auto Ventshade™, the Auto Ventshade™ logo, Chromelector™, and the AVS™ logo are trademarks of Lund International, Inc.





Bugflector® - Bugflector II® - Carflector® - Chrome Hood Shield™

Pour obtenir une installation correcte et le meilleur ajustement possible, lire toutes les instructions AVANT de commencer. Pour toute assistance technique ou obtention de pièces manquantes, appeler le service des relations avec la clientèle au 1-800-241-7219.

Informations importantes concernant la sécurité



- ATTENTION – Avant de conduire, s'assurer que le pare-insectes est solidement assujéti sur le véhicule.
- Ne pas utiliser les stations de lavage de voitures à brosses.
- Ne pas utiliser de solvants.
- Vérifier régulièrement le serrage des composants.

Contenu **NOTE :** votre produit pourrait différer de l'illustration.



Protecteur de capot



2 espaceurs pour capot



2 rondelles



2 vis



2 fixations



4 gommés

Outils nécessaires



Équipement de nettoyage



Linge propre

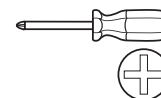

Outils appropriés

Préparation avant la peinture ou l'installation

- Effectuez un essai préalable afin de vérifier le bon positionnement et l'ajustement.
- Vérifiez la bonne pose des pièces avant de peindre car nous n'accepterons pas le renvoi de pièces modifiées ou peintes.
- Nettoyez et séchez votre véhicule afin d'éliminer les débris et/ou les poussières de la zone d'installation.

Étapes de l'installation **NOTE :** l'installation pourrait différer légèrement par rapport aux illustrations.

Ouvrez le capot.

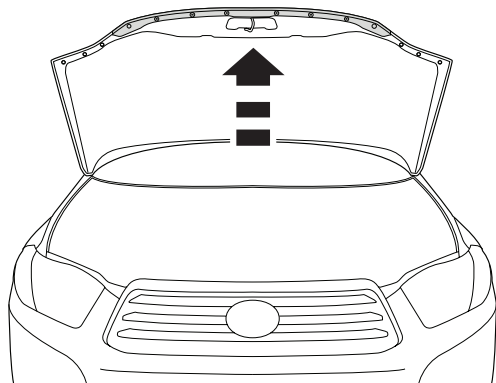

1

Retirez les 2 fixations pour coupe-froids.

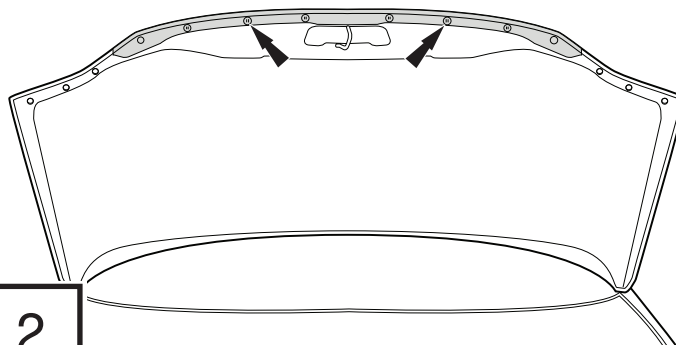

2

Étapes d'installation

REMARQUE : La méthode d'application peut être légèrement différente de celle représentée par les illustrations.



Installez les 2 espaceurs de capot
EN DESSOUS du coupe-froid.

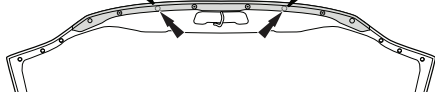
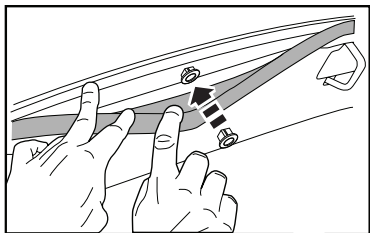

3

Centrez à l'avant du capot et alignez les orifices.

NOTE : les flasques internes doivent être
SOUS le coupe-froid.

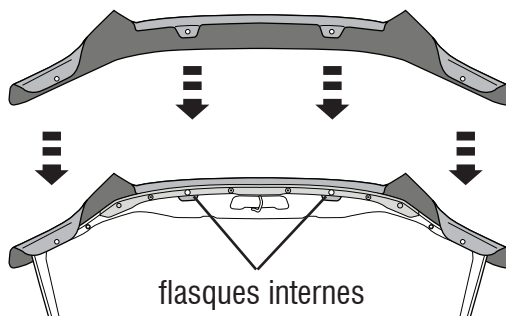

4

flasques internes

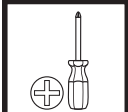

Installez 2 vis avec des rondelles sur les flasques internes.

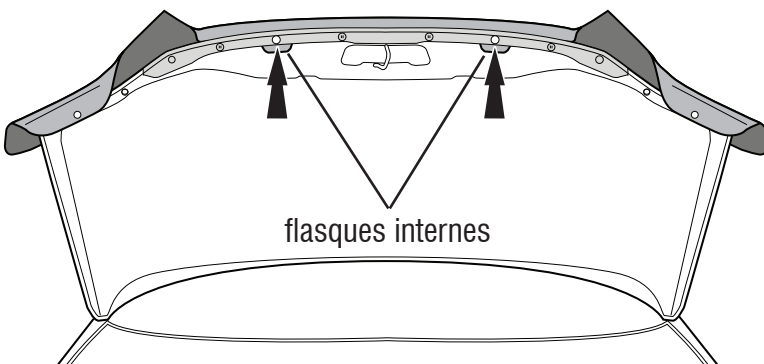

flasques internes

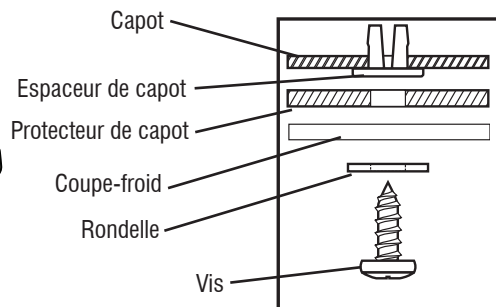

Capot

Espaceur de capot

Protecteur de capot

Coupe-froid

Rondelle

Vis

5

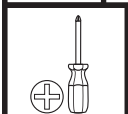

Installez 2 fixations sur les flasques externes.

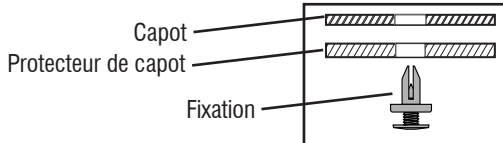
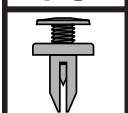

Capot

Protecteur de capot

Fixation

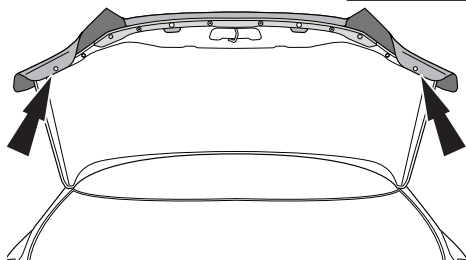

6



Fermez le capot. Placez les gommés sur la surface du capot.

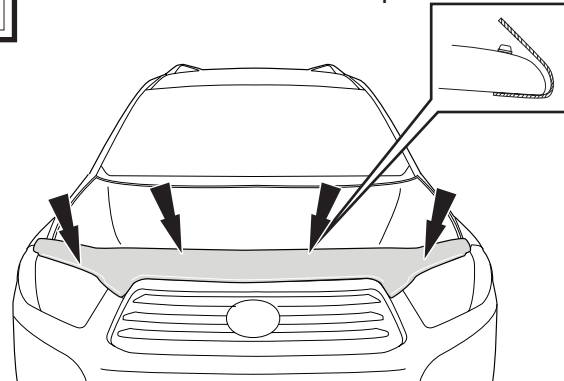

7

Entretien et nettoyage

- Laver exclusivement avec de l'eau savonneuse et sécher avec un chiffon propre.

Félicitations !

Vous avez acheté l'un des nombreux produits de qualité Auto Ventshade™ fabriqués par Lund International, Inc. Nous sommes extrêmement fiers de nos produits et souhaitons que vous tiriez des années de satisfaction de votre investissement. Nous avons pris toutes les mesures nécessaires pour assurer que ce produit est d'une qualité supérieure en ce qui concerne l'ajustement, la durabilité, la finition et la facilité d'installation.



AUTO VENTSHADE™

Lund International, Ventshade Accessories Division

655 Raco Drive, Lawrenceville, GA 30045, USA

800-241-7219 • Fax 770-339-5839 • Visitez notre site lundinternational.com

© 2007 Lund International, Inc. Tous droits réservés.



Auto Ventshade™ le logo Auto Ventshade™, Chromeflector™ et le logo AVS™ sont des marques déposées de Lund International, Inc.



Instrucciones de instalación

Hoja informativa N.º BF79 Rev. A



Bugflector® - Bugflector II® - Carflector® - Chrome Hood Shield™

Para una instalación adecuada y el mejor ajuste posible, lea todas las instrucciones ANTES de comenzar. Si desea recibir asistencia técnica u obtener piezas faltantes, llame al Servicio al cliente al 1-800-241-7219.

Información importante de seguridad



- PRECAUCIÓN - Antes de conducir, asegúrese de que la cubierta para capó esté correctamente anclada al vehículo.
- No utilice servicios automáticos de limpieza de vehículos que utilizan cepillos.
- No utilice limpiadores al solvente de ningún tipo.
- Compruebe periódicamente que todos los componentes estén ajustados.

Contenidos **NOTA:** El producto real puede diferir del de la ilustración.



Deflector de capó



2 accesorios de inserción del capó



2 arandelas



2 tornillos

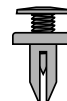

2 sujetadores



4 topos

Herramientas requeridas



Productos para el lavado de autos



Toalla limpia

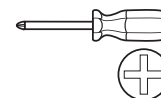

Herramientas manuales apropiadas

Preparación antes de la pintura / Instalación

- Se recomienda realizar una prueba de ajuste para garantizar una colocación y un ajuste correctos.
- Controle el ajuste de las piezas antes de pintar ya que no aceptaremos la devolución de piezas modificadas o pintadas.
- Lave y seque su vehículo para eliminar cualquier tipo de restos o suciedad de la superficie de instalación del deflector.

Pasos de la instalación **NOTA:** La colocación real puede ser un poco diferente a la indicada en las ilustraciones.

Abra el capó.

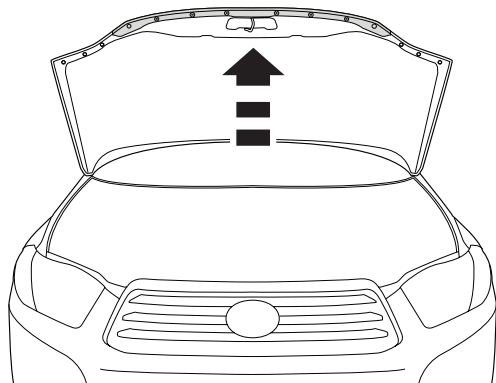

1

Quite los (2) retenes del burlete.

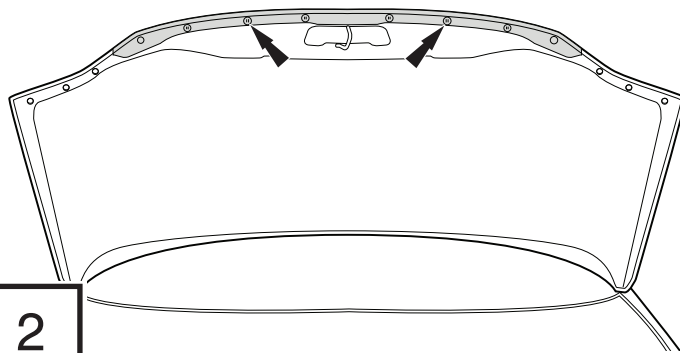

2

Pasos de instalación **AVISO:** La colocación real puede variar con respecto a las ilustraciones.



Coloque (2) accesorios de inserción en el capó **DEBAJO** del burlete.

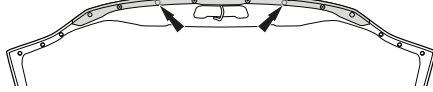
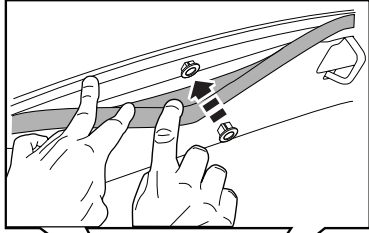

3

Coloque la pieza en el centro del borde frontal del capó y alinee los orificios. **NOTA:** Las bridas internas deben estar **DEBAJO** del burlete.

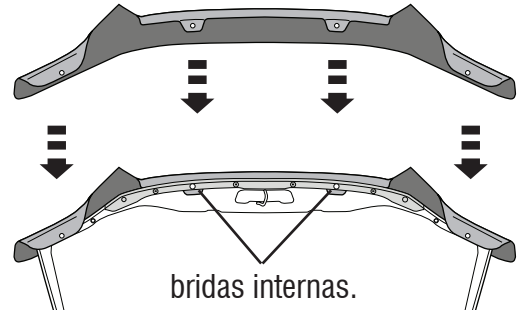

4

bridas internas.



Coloque (2) tornillos con arandelas en las bridas internas.

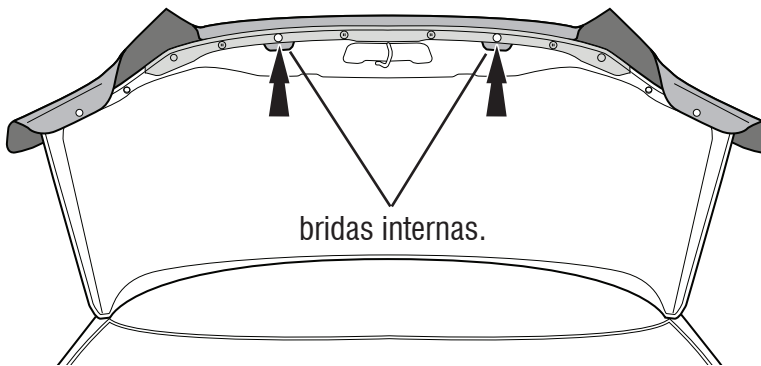
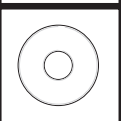

bridas internas.

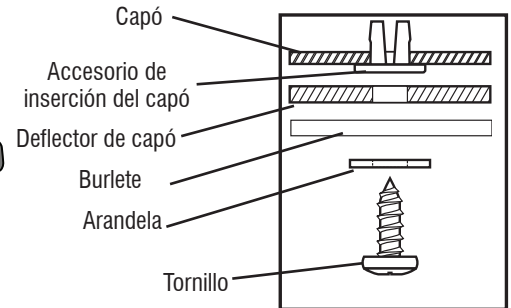

Capó

Accesorio de inserción del capó

Deflector de capó

Burlete

Arandela

Tornillo

5



Coloque (2) sujetadores en las bridas externas.

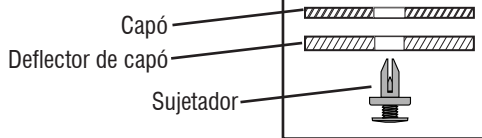
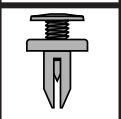

Capó

Deflector de capó

Sujetador

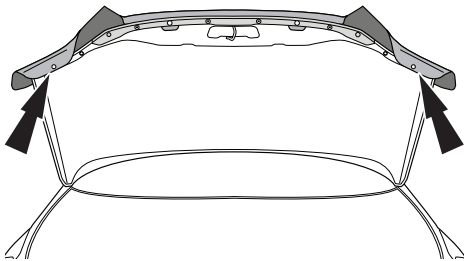

6



Cierre el capó. Coloque los toques en la superficie del capó.

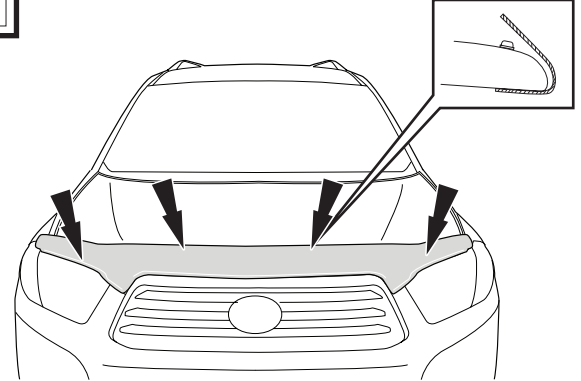

7

Cuidado y limpieza

- Limpie solamente con agua jabonosa tibia y seque con un paño limpio.

Felicidades

Usted ha comprado uno de los tantos artículos de calidad de Auto Ventshade™ ofrecidos por Lund International, Inc. Nuestros productos son nuestro mayor orgullo. Deseamos que disfrute de años de satisfacción con su inversión. Hemos realizado todos los esfuerzos para asegurarnos de que su producto sea de la mejor calidad en cuanto a ajuste, durabilidad, acabado y facilidad de instalación.



AUTO VENTSHADE™

Lund International, Ventshade Accessories Division

655 Raco Drive, Lawrenceville, GA 30045

800-241-7219 • Fax 770-339-5839 • Visite nuestro sitio Web: lundinternational.com

© 2007 Lund International, Inc. Todos los derechos reservados.



™ Auto Ventshade™ el logo de Auto Ventshade™, Chromeflector™ y el logo de AVS™ son marcas comerciales de Lund International, Inc.

