

Installation Instructions

I - Sheet Number BF91 Rev.A



Bugflector® - Bugflector II® - Carflector® - Chrome Hood Shield™

For proper installation and best possible fit, please read all instructions **BEFORE** you begin.
For technical assistance or to obtain missing parts, please call Customer Relations at 1-800-241-7219.

Important Safety Information



- CAUTION - Before driving, ensure that the hood shield is properly secured to vehicle.
- Do not use automatic "brush-style" car washes.
- Do not use cleaning solvents of any kind.
- Periodically check all components for tightness.

Contents **NOTE:** Actual product may vary from illustration.



Hood shield



Scrivet x2
(#98030)



Screw x2
(#98037)



Washer x2
(#98038)



Well Nut x2
(#98039)



Bump On x4
(#98024)

Tools Required



Car Wash Supplies

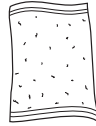

Clean Towel

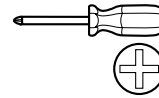

Phillips Head Screwdriver

Preparation Before Painting / Installation

- A trial fit is recommended to ensure proper positioning and fit.
- Check fit of parts before painting as we will not accept the return of modified or painted parts.
- Wash and dry your vehicle to remove any debris and/or dirt from the installation area.

Installation Steps **NOTE:** Actual application may vary slightly from illustrations.

Raise Hood.

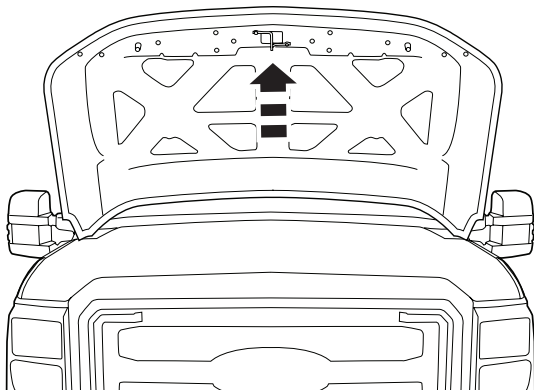

1

Clean the area around the leading edge of the hood with a clean cloth.

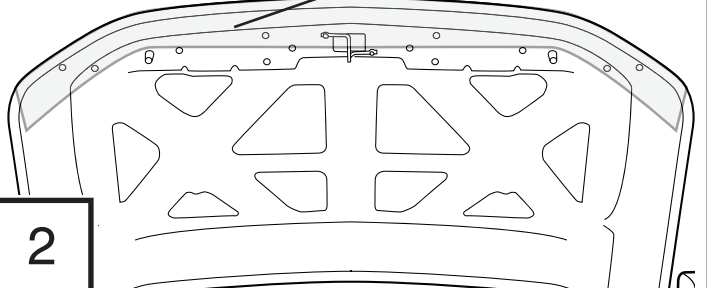

2

Installation Steps

NOTE: Actual application may vary slightly from illustrations.

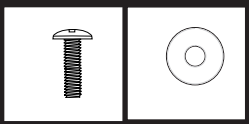

Attach fasteners to the (2) outboard hoodshield flanges by inserting screw with washer through the hood shield, and into well nut. **Partially** thread screw into well nut.

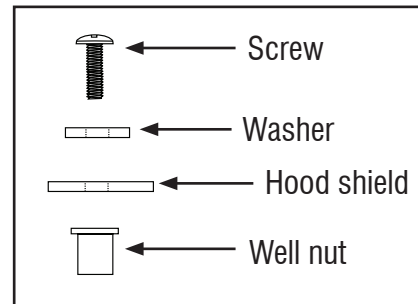
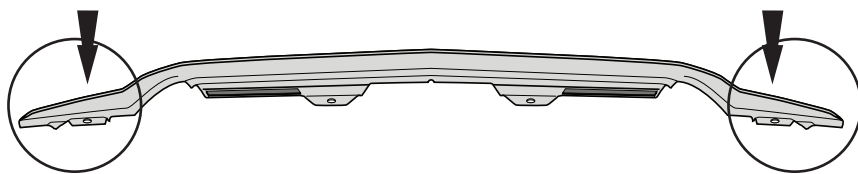
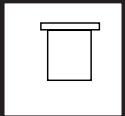

3

Expose 2" (5 cm) of tape liner from each end of the center flanges on the hood shield. Ensure that free ends are accessible.

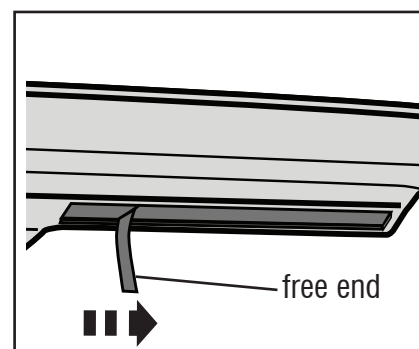
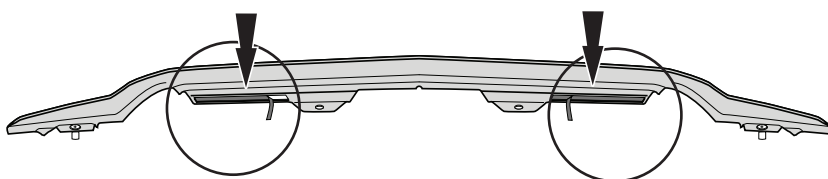

4

Center part on front edge of hood and align holes.

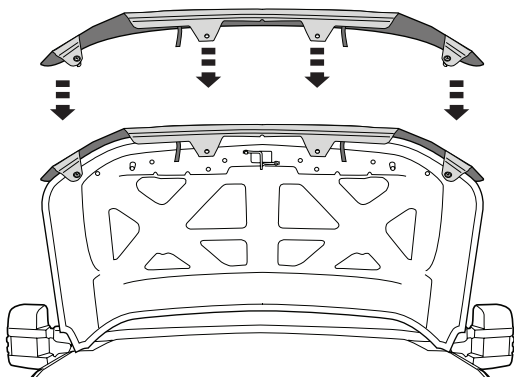

NOTE: Observe the alignment from the side view in order to guide the hood shield with its attached fastener into the proper hole in the hood.

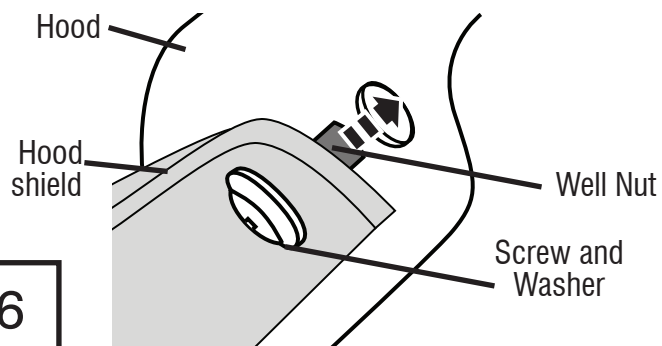

5

6

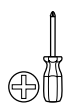

With the fastener assembly inserted into hole in hood, secure hood shield to hood by tightening screw to expand well nut. Repeat for remaining fastener.

Note the (2) inboard hole locations.

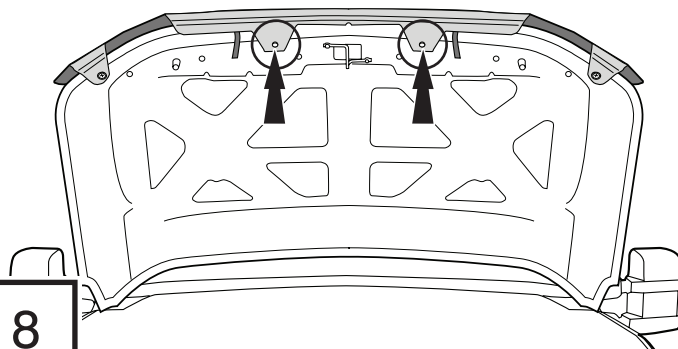
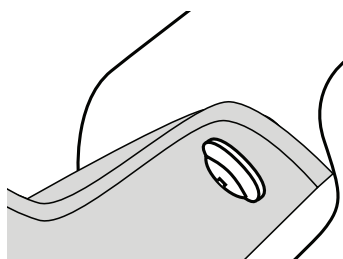

7

8

NOTE: DO NOT OVER TIGHTEN

Installation Steps

NOTE: Actual application may vary slightly from illustrations.



Install (2) Scrivet fasteners with phillips head screwdriver at the inboard holes.

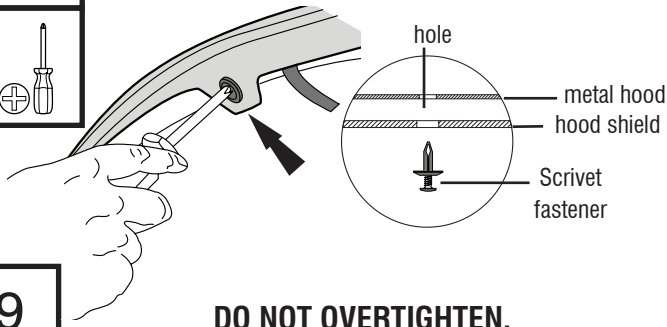

9

DO NOT OVERTIGHTEN.

Remove remaining tape liner by pulling on the free ends.

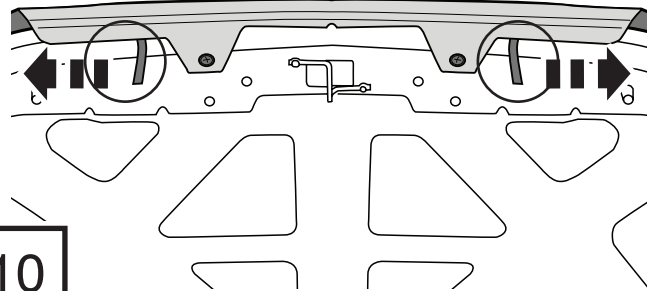

10

Apply pressure to flange to ensure proper adhesion of tape.

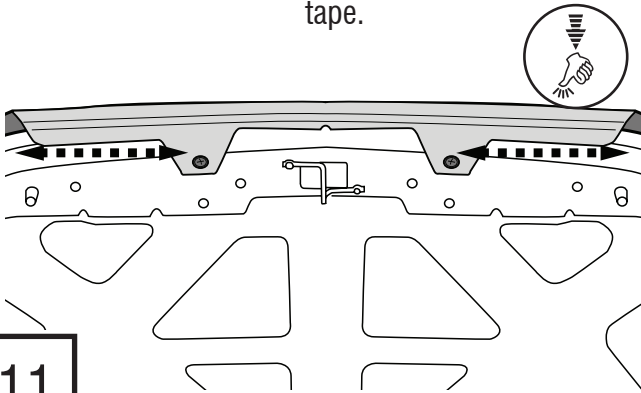

11

Turn both of the hood bumpers counter clockwise (2) full turns.

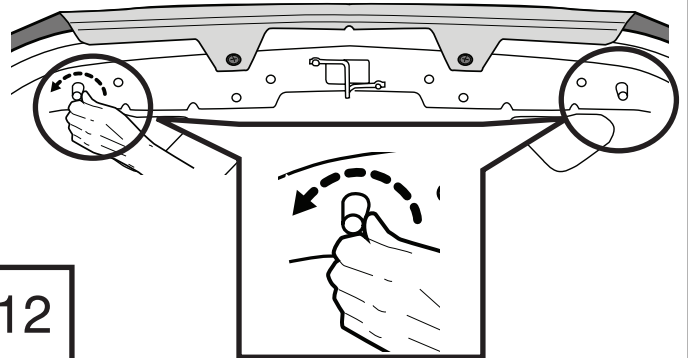

12

Close hood and apply (4) bump ons to hood surface.

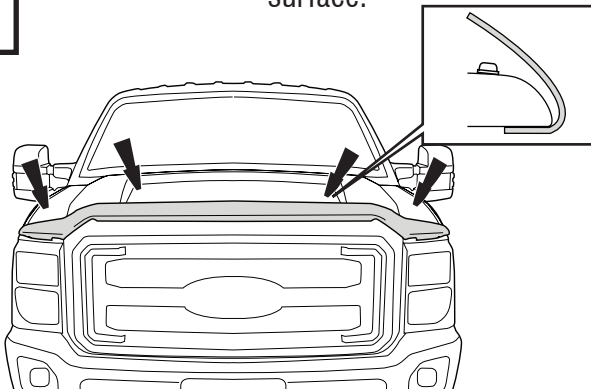

13

Care and Cleaning

- Wash only with mild soap & dry with a clean cloth.

Congratulations!

You have purchased one of the many quality Auto Ventshade™ branded products offered by Lund International, Inc. We take the utmost pride in our products and want you to enjoy years of satisfaction from your investment. We have made every effort to ensure that your product is top quality in terms of fit, durability, finish and ease of installation.



AUTO VENTSHADE™

Lund International, Ventshade Accessories Division
655 Raco Drive, Lawrenceville, GA 30045
800-241-7219 • Fax 770-339-5839 • Visit us at lundinternational.com

© 2010 Lund International, Inc. All rights reserved.

Auto Ventshade™, the Auto Ventshade™ logo, Chromelector™, and the AVS™ logo are trademarks of Lund International, Inc.



Instructions d'installation

I- Feuille numéro BF91 Rév.A



Bugflector® - Bugflector II® - Carflector® - Chrome Hood Shield™

Pour obtenir une installation correcte et le meilleur ajustement possible, lire toutes les instructions AVANT de commencer.
Pour toute assistance technique ou obtention de pièces manquantes, appeler le service des relations avec la clientèle au 1-800-241-7219.

Informations importantes concernant la sécurité



- ATTENTION – Avant de conduire, s'assurer que le pare-insectes est solidement assujettie sur le véhicule.
- Ne pas utiliser les stations de lavage de voitures à brosses.
- Ne pas utiliser de solvants.
- Vérifier régulièrement le serrage des composants.

Contenu **NOTE:** Le produit réel peut changer de l'illustration.



Protecteur de capot



2 rivets
(n°98030)



2 vis
(n°98037)



2 rondelles
(n°98038)



2 écrous à
rivet borgne
(n°98039)



4 gommes
(n°98024)

Outils nécessaires



Équipement de nettoyage

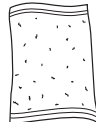

Chiffon propre

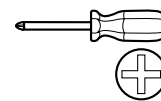

Tournevis Phillips

Préparation pour la peinture/l'installation

- Il est recommandé de procéder à un essai pour s'assurer que le positionnement et l'ajustement sont corrects.
- Vérifier l'ajustement des pièces avant peinture, car nous n'acceptons pas le retour de pièces modifiées ou peintes.
- Laver les glissières de glaces de la portière du véhicule pour éliminer toute poussière et tous débris.
- Sécher les glissières avec une serviette propre.

Étapes d'installation **REMARQUE :** La méthode d'application peut être légèrement différente de celle représentée par les illustrations.

Relevez le capot.

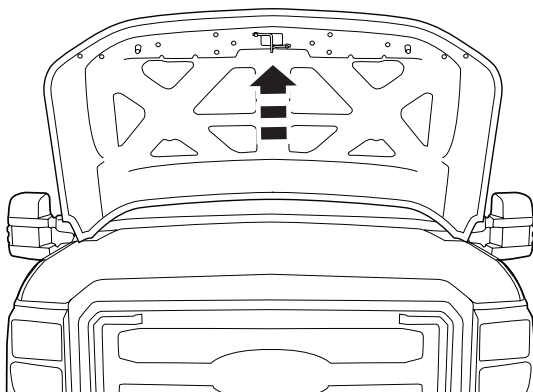

1

Nettoyez le bord avant du capot à l'aide d'un linge propre.

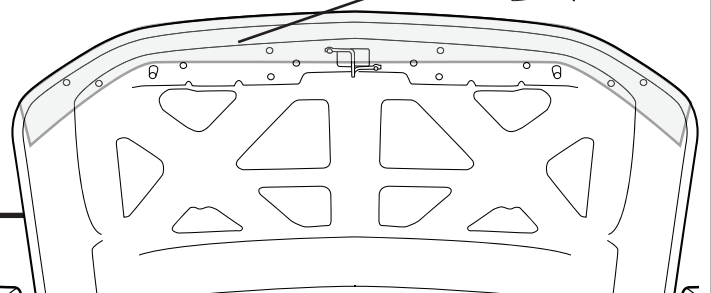

Étapes d'installation

REMARQUE : La méthode d'application peut être légèrement différente de celle représentée par les illustrations.



Attachez les fixations sur les 2 rebords extérieurs du protecteur de capot en insérant la vis avec la rondelle par le protecteur de capot et dans l'écrou à rivet borgne. Insérez **partiellement** la vis dans l'écrou à rivet borgne.

3

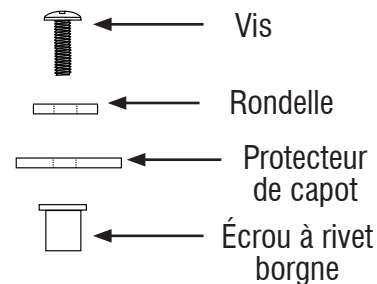
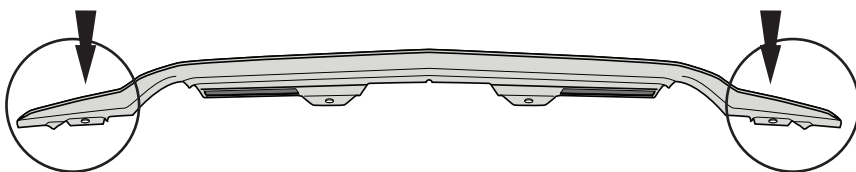

Exposez 2 pouces (5 cm) de la bande autocollante à chaque extrémité des rebords au centre sur le protecteur de capot. Vérifiez que les extrémités décollées de la bande sont accessibles.

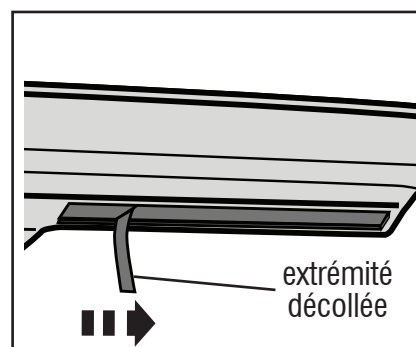
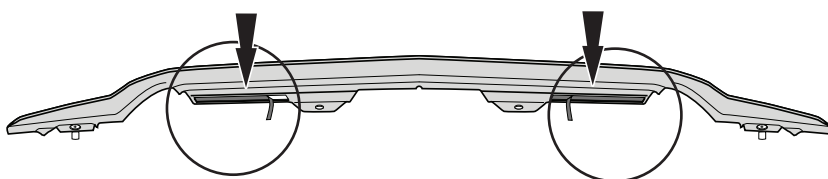

4

Centrez la pièce à l'avant du capot et alignez les orifices.

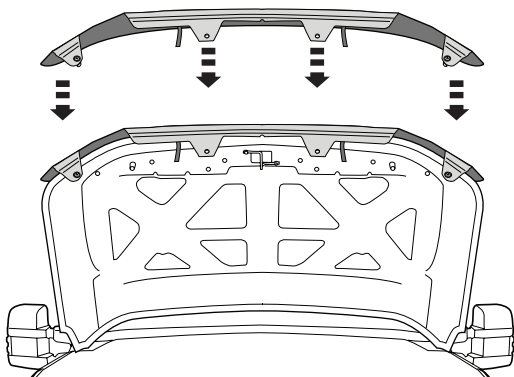

REMARQUE : Respectez l'alignement ci-dessous afin de guider le protecteur de capot et sa fixation dans l'orifice adéquat du capot.

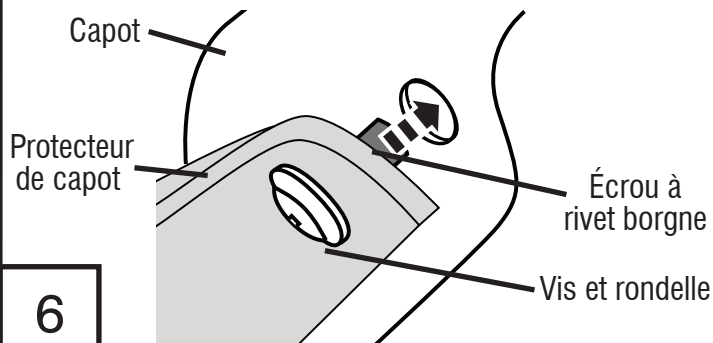

5

6



Une fois que l'ensemble de la fixation est inséré dans l'orifice du capot, fixez le protecteur de capot en serrant la vis dans l'écrou à rivet borgne. Répétez la même procédure pour l'autre fixation.

Notez les emplacements des 2 orifices intérieurs.

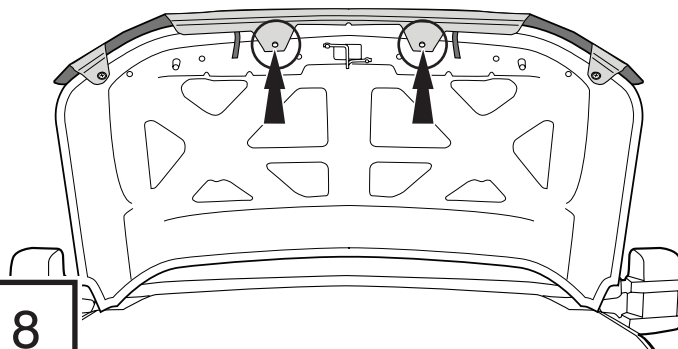
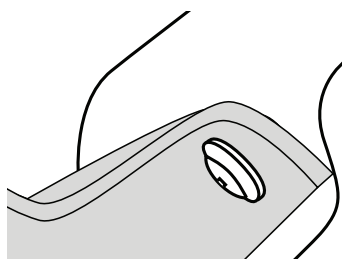

7

8

REMARQUE : NE PAS SERRER À L'EXCÈS

Étapes d'installation

REMARQUE : La méthode d'application peut être légèrement différente de celle représentée par les illustrations.



Installez les 2 rivets à l'aide du tournevis Phillips dans les orifices intérieurs.

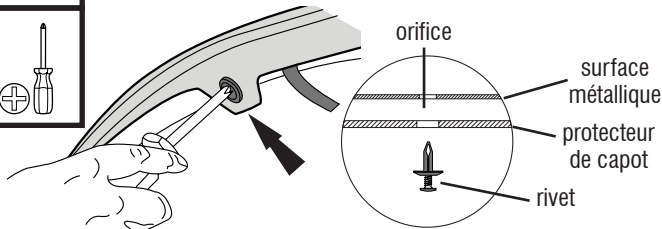

9

NE PAS SERRER À L'EXCÈS.

Retirez l'excès de bande autocollante en tirant des extrémités décollées.

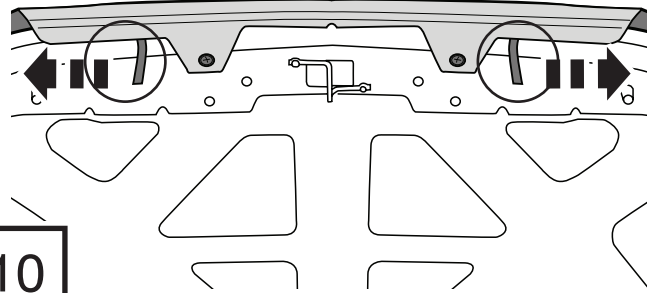

10

Exercez une pression sur le rebord afin de vous assurer que la bande adhésive colle bien.

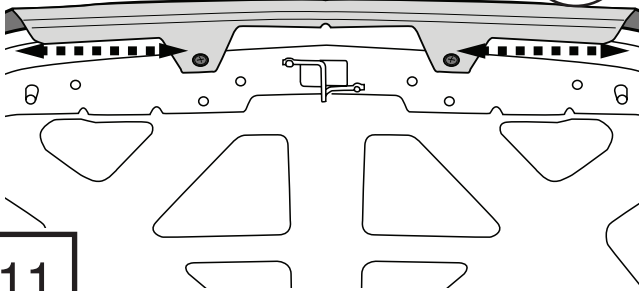

11

Tournez de 2 tours complets les deux butées du capot dans le sens anti-horaire.

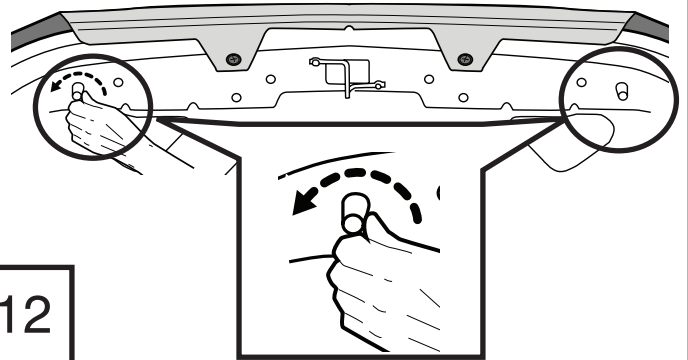

12

Fermez le capot. Posez les 4 gommes sur la surface du capot.

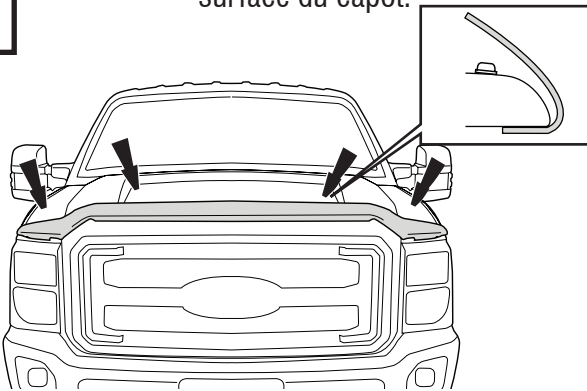

13

Entretien et nettoyage

- Laver exclusivement avec de l'eau savonneuse et sécher avec un chiffon propre.

Félicitations !

Vous avez acheté l'un des nombreux produits de qualité Auto Ventshade™ fabriqués par Lund International, Inc. Nous sommes extrêmement fiers de nos produits et souhaitons que vous tiriez des années de satisfaction de votre investissement. Nous avons pris toutes les mesures nécessaires pour assurer que ce produit est d'une qualité supérieure en ce qui concerne l'ajustement, la durabilité, la finition et la facilité d'installation.



AUTO VENTSHADE™
Lund International, Ventshade Accessories Division
655 Raco Drive, Lawrenceville, GA 30045, USA

800-241-7219 • Fax 770-339-5839 • Visitez notre site lundinternational.com

© 2010 Lund International, Inc. Tous droits réservés.



Auto Ventshade™ le logo Auto Ventshade™, Chromeflector™ et le logo AVS™ sont des marques déposées de Lund International, Inc.



Instrucciones de instalación

Hoja informativa N.º BF91 Rev. A



Bugflector® - Bugflector II® - Carflector® - Chrome Hood Shield™

Para una instalación adecuada y el mejor ajuste posible, lea todas las instrucciones ANTES de comenzar. Si desea recibir asistencia técnica u obtener piezas faltantes, llame al Servicio al cliente al 1-800-241-7219.

Información importante de seguridad



- PRECAUCIÓN - Antes de conducir, asegúrese de que la visera deflectora esté correctamente anclada al vehículo.
- No utilice servicios automáticos de limpieza de vehículos que utilizan cepillos.
- No utilice limpiadores al solvente de ningún tipo.
- Compruebe periódicamente que todos los componentes estén ajustados.

Contenido

NOTA: El producto real puede variar de la ilustración.



Protector de capó



Sujetadores Scrivet x2
(#98030)



Tornillo x2
(#98037)



Arandela x2
(#98038)



Remache de tuerca ciego x2
(#98039)



Marcadores táctiles x4
(#98024)

Herramientas necesarias



Elementos para el lavado del coche



Toalla limpia

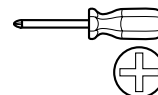

Destornillador Phillips

Preparación antes de pintar o instalar

- Se recomienda realizar un ajuste de prueba para asegurar el posicionamiento y ajuste correctos.
- Compruebe que las piezas se ajusten correctamente antes de pintarlas, ya que no aceptaremos la devolución de piezas modificadas o pintadas.
- Lave los canales de la ventanilla del vehículo para quitar los desechos y la suciedad.
- Seque los canales de la ventanilla con una toalla limpia.

Pasos de instalación

NOTA: El uso real puede variar levemente de ilustraciones.

Levante el capó.

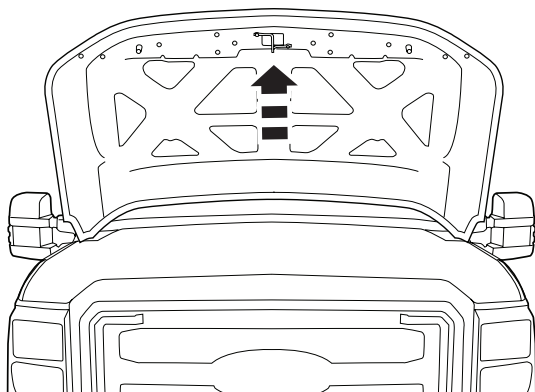

1

Limpie la zona alrededor del borde delantero del capó con un trapo limpio.

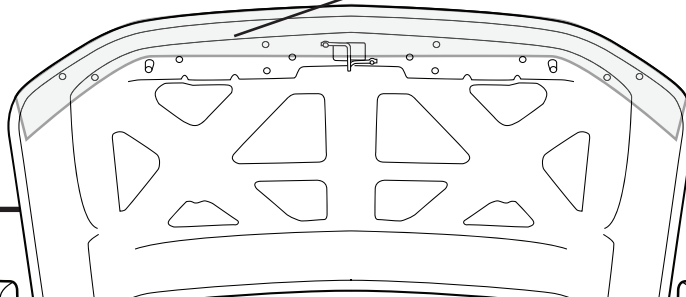

Pasos de instalación

NOTA: El uso real puede variar levemente de ilustraciones.



Acople los sujetadores a las (2) bridas protectoras del protector de capó exterior colocando un tornillo con una arandela a través del protector del capó y dentro del remache de tuerca ciego. **Parcialmente**, enrosque el tornillo dentro del remache.

3

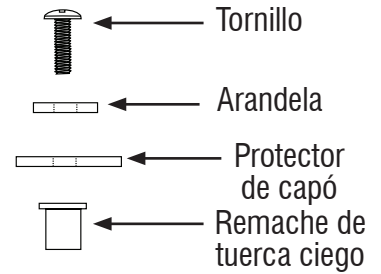
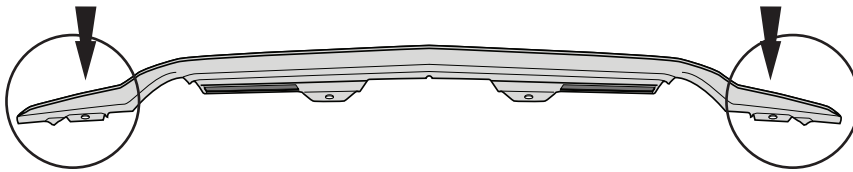

Despegue 2" (5 cm) del revestimiento adhesivo de cada extremo de las bridas centrales del protector de capó. Asegúrese de que los extremos libres sean accesibles.

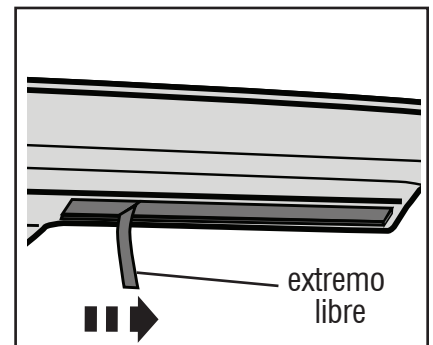
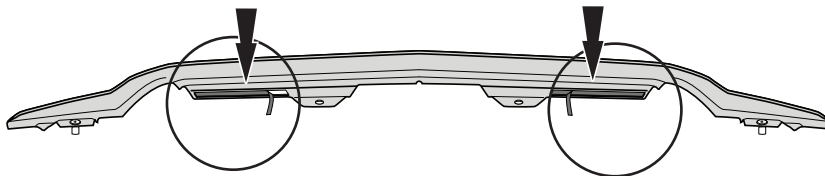

4

Centre la pieza en el borde delantero del capó y alinee los orificios.

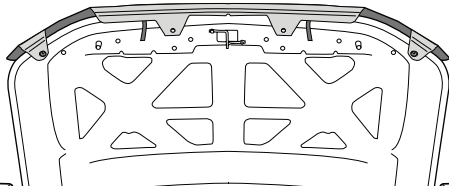
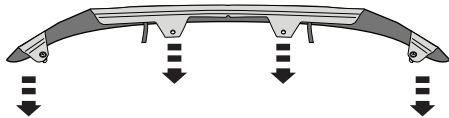

5

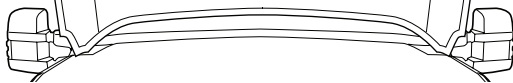

NOTA: Observe la alineación desde el costado para guiar el protector de capó con los sujetadores acoplados en el orificio correcto del capó.

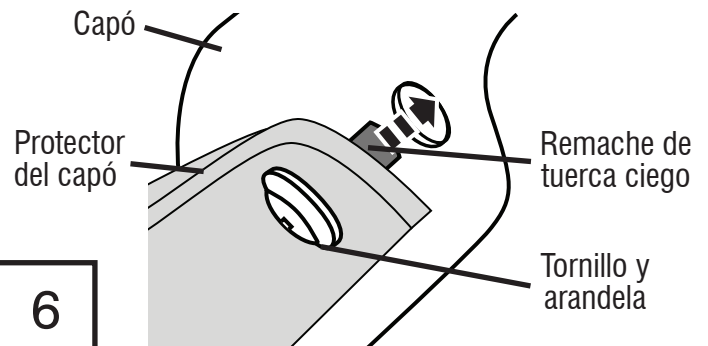

6

Con el conjunto del sujetador dentro del orificio del capó, fije el protector en el capó apretando el tornillo para expandir el remache de tuerca ciego. Repita esto con los sujetadores restantes.

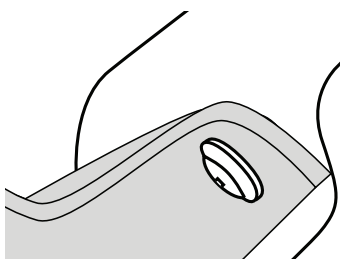
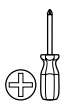

7

NOTA: NO APRIETE EN EXCESO

Tenga en cuenta las (2) ubicaciones de los orificios en el interior.

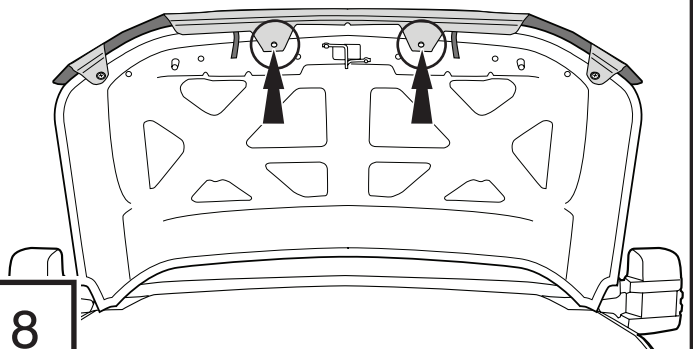

8

Pasos de instalación

NOTA: El uso real puede variar levemente de ilustraciones.



Instale los (2) sujetadores Scrivet con el destornillador Phillips en los orificios del interior.

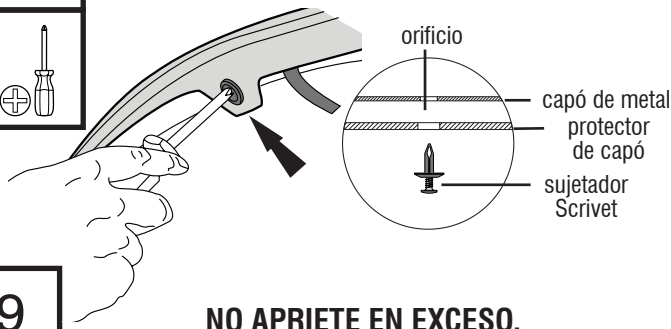

9

NO APRIETE EN EXCESO.

Retire el revestimiento adhesivo restante tirando de los extremos libres.

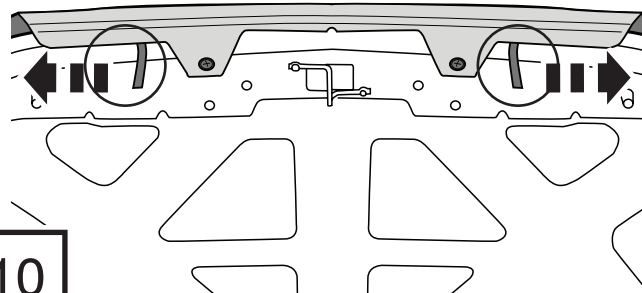

10

Aplique presión en la brida para asegurar la correcta adhesión de la cinta.

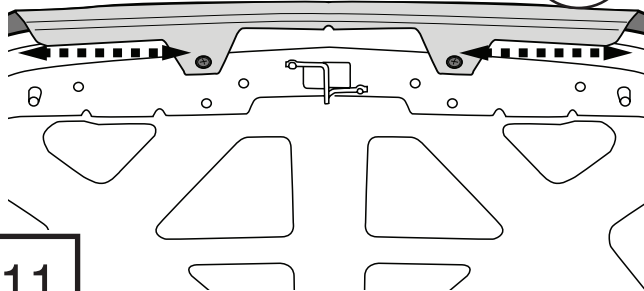

11

Gire ambos toques del capó en sentido antihorario (2) vueltas completas.

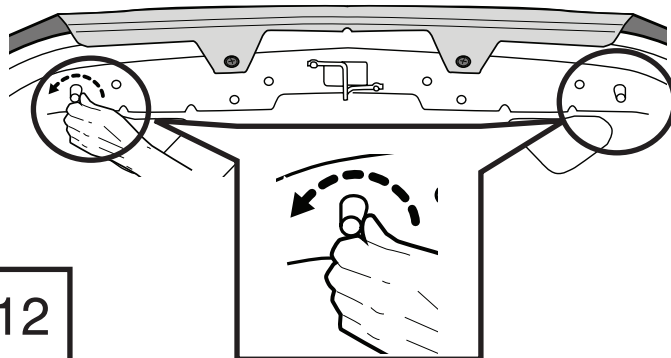

12



Cierre el capó y coloque (4) marcadores táctiles en la superficie del capó.

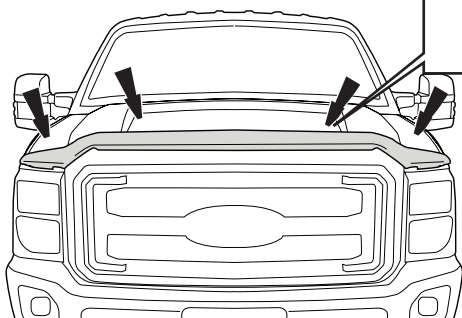
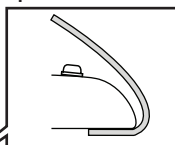

13

Cuidado y limpieza

- Limpie solamente con agua jabonosa tibia y seque con un paño limpio.

Felicidades

Usted ha comprado uno de los tantos artículos de calidad de Auto Ventshade™ ofrecidos por Lund International, Inc. Nuestros productos son nuestro mayor orgullo. Deseamos que disfrute de años de satisfacción con su inversión. Hemos realizado todos los esfuerzos para asegurarnos de que su producto sea de la mejor calidad en cuanto a ajuste, durabilidad, acabado y facilidad de instalación.



AUTO VENTSHADE™

Lund International, Ventshade Accessories Division

655 Raco Drive, Lawrenceville, GA 30045

800-241-7219 • Fax 770-339-5839 • Visite nuestro sitio Web: lundinternational.com

© 2010 Lund International, Inc. Todos los derechos reservados.



™ Auto Ventshade™ el logo de Auto Ventshade™, Chromeflector™ y el logo de AVS™ son marcas comerciales de Lund International, Inc.

