



22-C Ford Expedition Mud Flap Set, Rear Mounting Diagram & Instructions Anodized

IMPORTANT:

Manufacturer is not responsible for negligent use of vehicle with mud flaps installed, including over-tightening of screws and bolts causing damage to vehicle or mud flaps.



TOOLS REQUIRED-

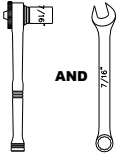

7/16" Socket Wrench
and Open Wrench



Push Pin Removal Tool



Philips
Screwdriver

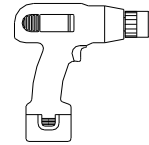

Electric or re-chargeable
Drill



1/4" Drill Bit

FLAPS

(1) Flap Assembly,
Front, DS

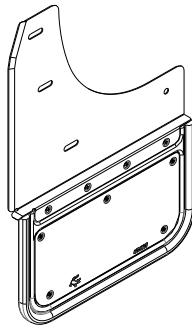

(1) Flap Assembly
Front, PS

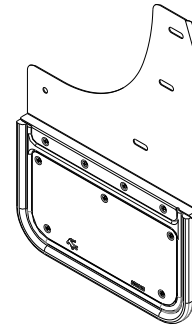

PARTS BAG # 770581

a) (8) Capscrew,
1/4"-20 x 1", SS Blk Ox.
Part #014073

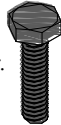

b) (10) Washer, Flat
0.281" x 1", 18ga, SS Blk Ox.
Part #018069

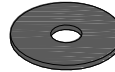

c) (2) Washer, Lock
1/4" SS,
Part #024000



d) (2) Nut, Hex
1/4-20, SS
Part #025000



e) (6) Spring Nut
1/4-20 x 0.54" Reach
Part #028010

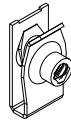

f) (8) Washer, Nylon
0.281" x 0.885" x 0.062"
Part #054080



g) (2) Durashield
5/8" X 13" Protecti.
Part #766424

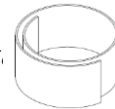

INSTALLATION (For ease of installation it is suggested that the wheel be removed)

1. Before you install your Mud Flap Set, see the diagram and parts list for all necessary parts.
2. Remove the four factory push pins located on the inner fender.
3. Pull back the liner and install spring nuts (e) to the tabs that hold the liner in place.
4. Hold the mud flap in place and use a marker to mark about 1/4" above the mud flap.

5. Install durastrip (g) from the mark down the edge of the vehicle. This protects the paint and body from the mud flap.
6. Loosely install mud flap holes #1 to #3 to spring nuts (e) using a capscrew (a), flat washer (b), and nylon washer (f).
7. Push the mud flap hole #4 against the factory liner and drill a 1/4" hole through the mud flap hole into the factory liner.
8. Loosely install mud flap hole #4 to liner using a capscrew (a), flat washer (b), and nylon washer (f) and secure using a flat washer (b), lock washer (c), and hex nut (d).
9. Using a square or another levelling tool, ensure that the mud flap is level. Tighten all fasteners.
10. Repeat procedure on passenger side.

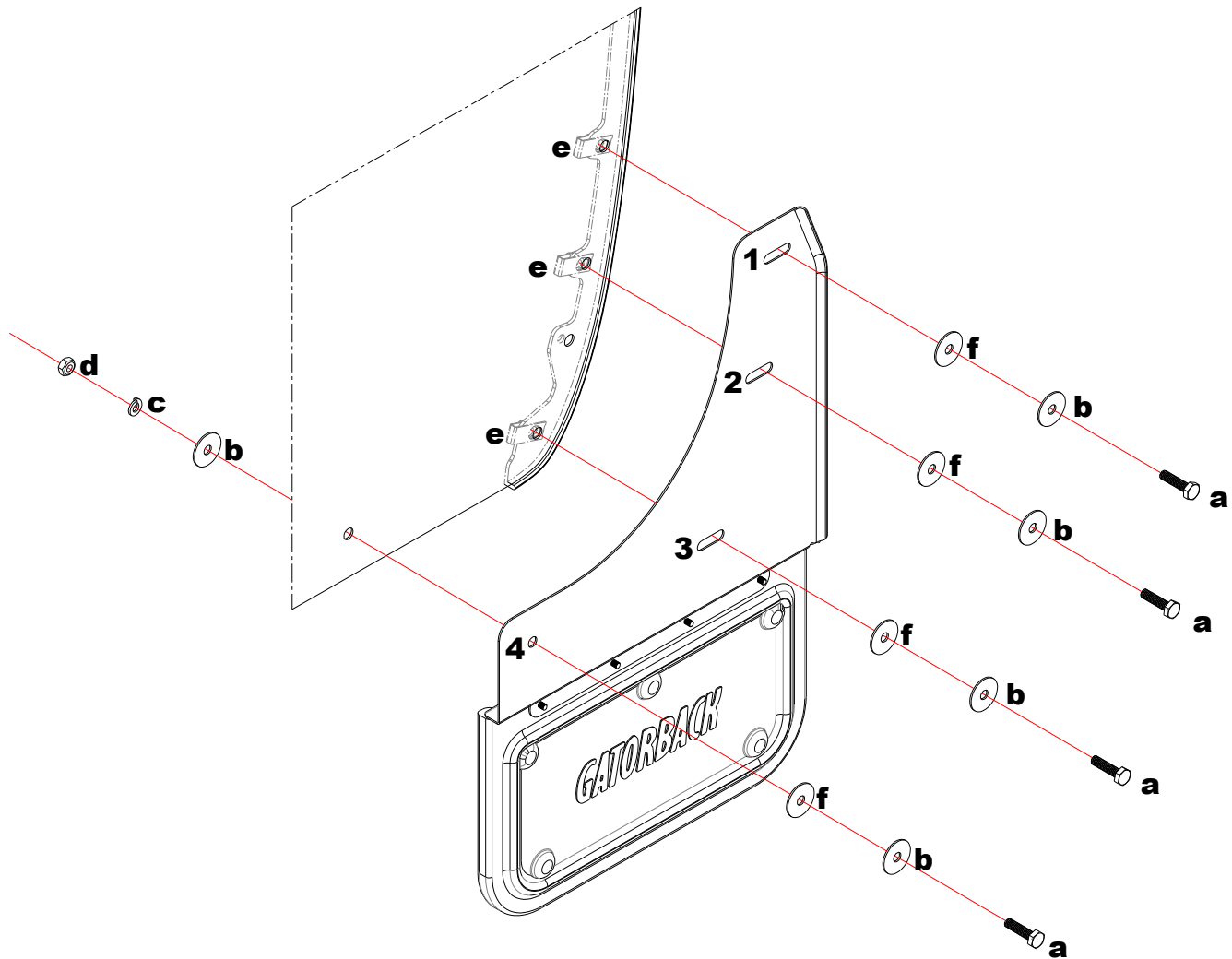

Please check out our YouTube channel to see an install video for this application.

