



2019 Ford Ranger
Mud Flap Set, Rear
Mounting Diagram & Instructions
Kit# GCR45R

IMPORTANT:

Manufacturer is not responsible for negligent use of vehicle with mud flaps installed, including over-tightening of screws and bolts causing damage to vehicle or mud flaps.

TOOLS REQUIRED-

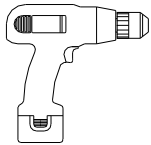

Electric or Rechargeable Drill



1/4" Drill Bit



Push Pin Removal Tool

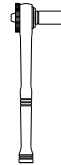

OR

3/8" Open Wrench or Socket Wrench

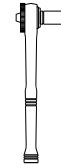

OR

5/16" Open Wrench or Socket Wrench

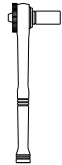

OR

7/16" Open Wrench or Socket Wrench

FLAPS

(1) Flap Rear, DS

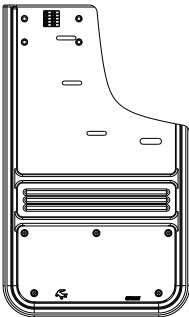

(1) Flap Rear, PS

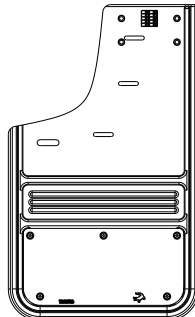

(1) Bracket Rear, DS Part #767040



(1) Bracket Rear, PS Part #767041



PARTS BAG # 767089

a) (6) Bolt, Hex Flange SS, M4.2 x 1" Black Part #016041

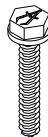

b) (4) Capscrew SS, 1/4-20 x 1" Part #014007



c) (8) Washer, Flat 1 OD", SS Part #018028

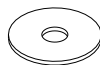

d) (6) Washer, Flat, Blk Ox. 0.203" ID x 1" OD, SS Part #018070



d) (6) Washer, Flat 0.190" x 0.885", Nylon Part #054080



e) (4) Lock Washer SS, 1/4", Helicoil Part #024000



f) (4) Nut, Hex SS, 1/4-20 Part #025000



g) (6) U-Clamp 1.50" x 4" x 0.125" Part #766960

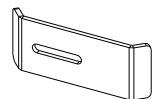

INSTALLATION *(For ease of installation it is suggested that the wheel be removed)*

1. Before you install your Mud Flap Set, see the diagram and parts list for all necessary parts.
2. Remove the (1) factory push pin from hole number #1 on Diagram "A" and discard.
3. Remove the (1) factory screw from hole #2 on Diagram "A" and set aside to reinstall later.
4. Gently pull flare out and install bracket between flare and inner liner, aligning hole #1 with hole #3 and hole #2 with hole #4.
Note: Bracket will require slight bend to properly fit
5. Re-install screw in bottom of flare (Diagram "A" hole #2 and #4)

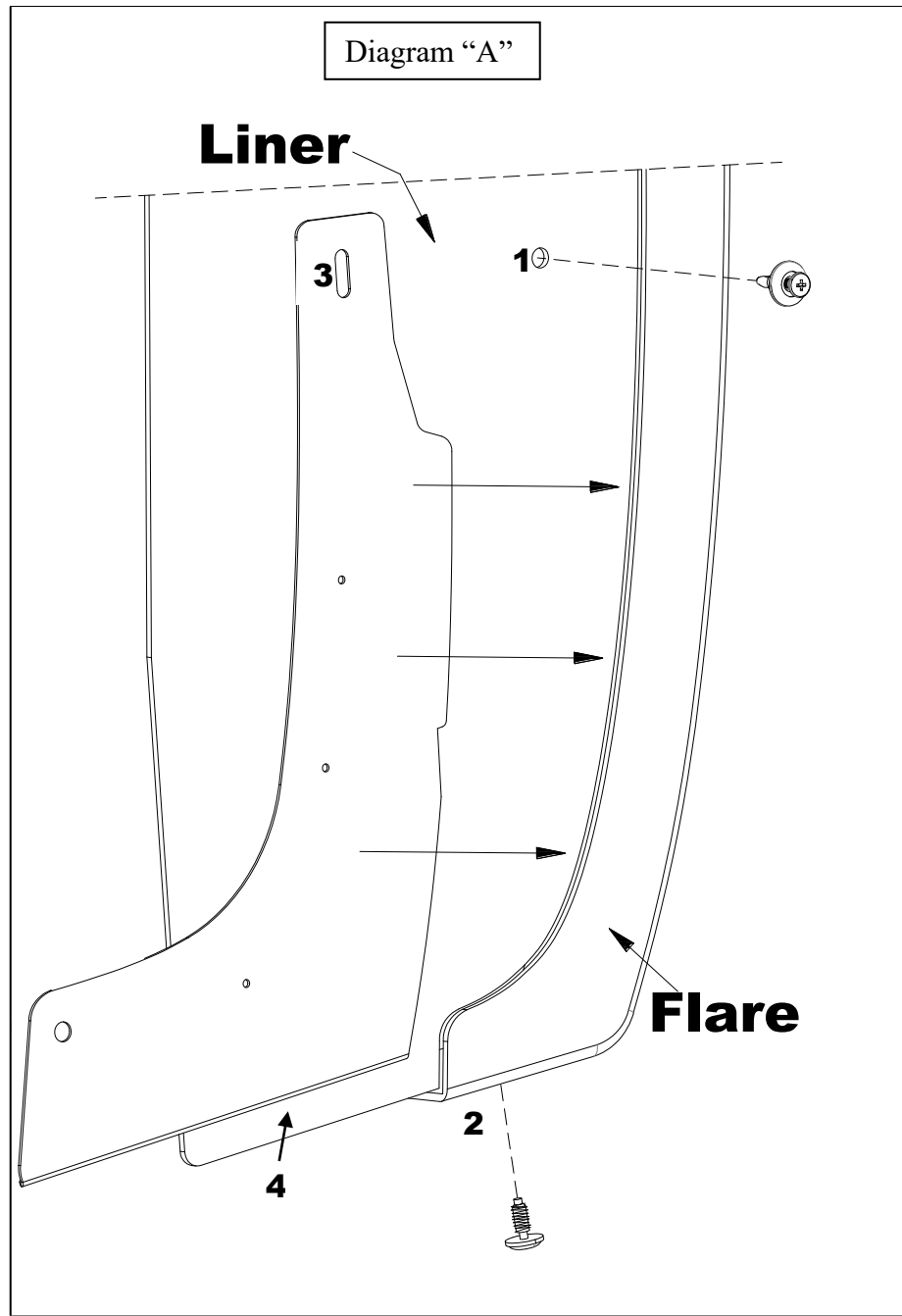

6. Install supplied capscrew (014007), washers (018028), lock washer (024000), and nut (025000) through holes #1 and #3 as shown in Diagram "B"
7. Align slots #5 to #7 with the dimples in the bracket and fasten using supplied U-Clamps (766960), nylon washer (054080), black stainless washer (018070), and bolt (016041) as shown in Diagram "B"
8. Before tightening, ensure that the flap is level using a square or bubble level. Do not over tighten.
9. Using hole #8 on the mud flap and hole #9 on the bracket as a guide, drill a 1/4" hole through the inner fender liner.
10. Fasten the mud flap hole #8 to the liner through hole #9 using a capscrew (014007), two stainless steel washer (018028), lock washer (024000), and nut (025000).
11. Tighten all fasteners
12. Repeat on passenger side.

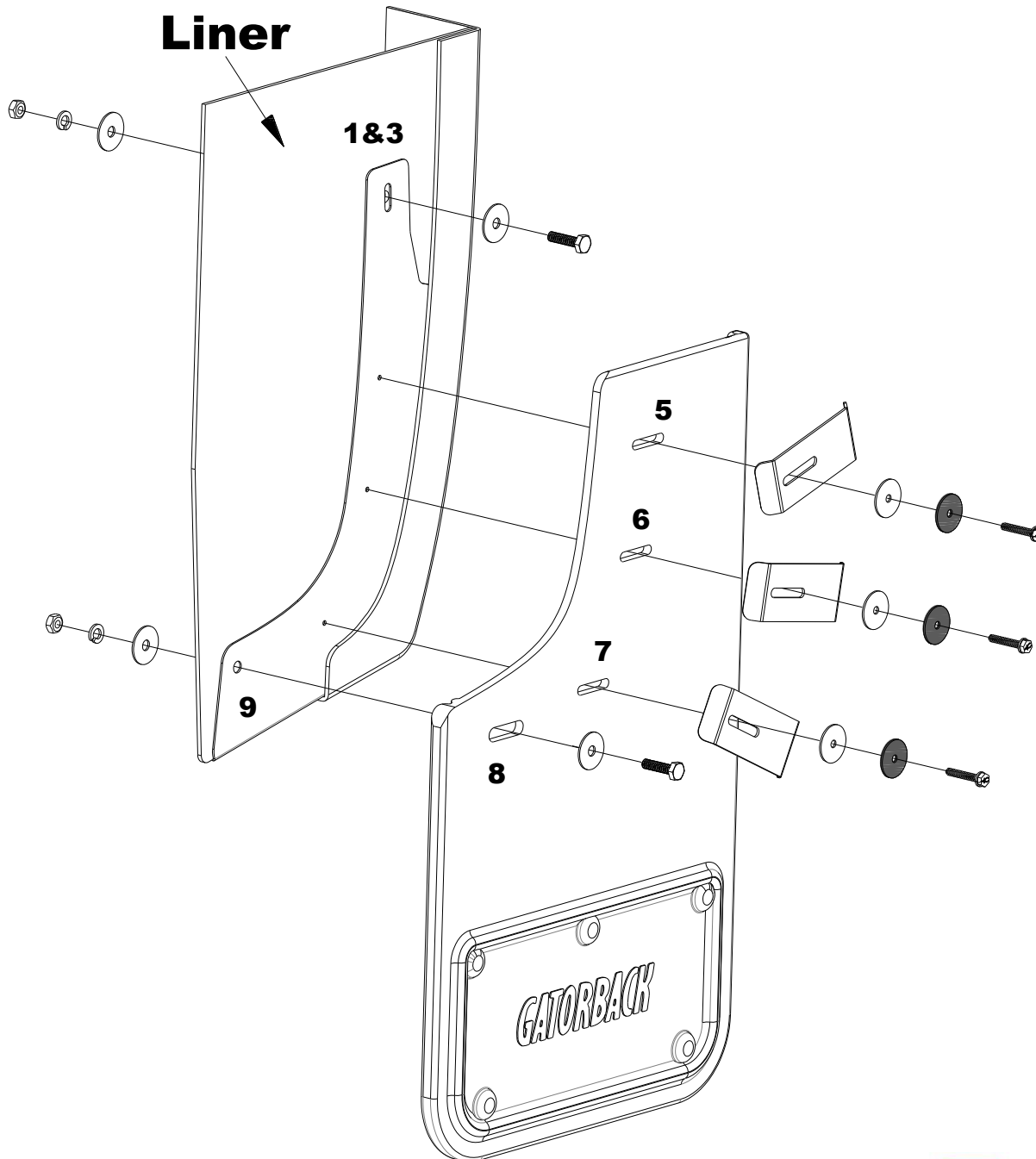

Please check out our YouTube channel to see an install video for this application.

