

LoadLifter 7500 XL™



Installation Guide



Ford F250/F350



Watch the video
Info on Table of Contents page

Kit 57550

For maximum effectiveness and safety, please read these instructions completely before proceeding with installation.

Failure to read these instructions can result in an incorrect installation.

TABLE OF CONTENTS

Installation Diagram	2
Hardware and Tools Lists	3
Introduction	4
Notation Explanation	4
Installing the System	5
Preparing the Vehicle.	5
Installing the Upper Frame Brackets.	5
Air Spring and Bracket Assembly	6
Prepping the Vehicle	
F350 DRW Models Only	10
All Models.	11
Installing the Air Spring Assemblies	13
Installing the Air Lines	17
Installing the Heat Shield.	18
Finished Installation Photos	19
Installation Checklist	21
Maintenance and Use Guidelines	21
Limited Warranty and Return Policy	21

Video-enhanced installation guides

Visit airliftcompany.com/workshop/category/install-videos to access our installation video archive*.

Installation Diagram

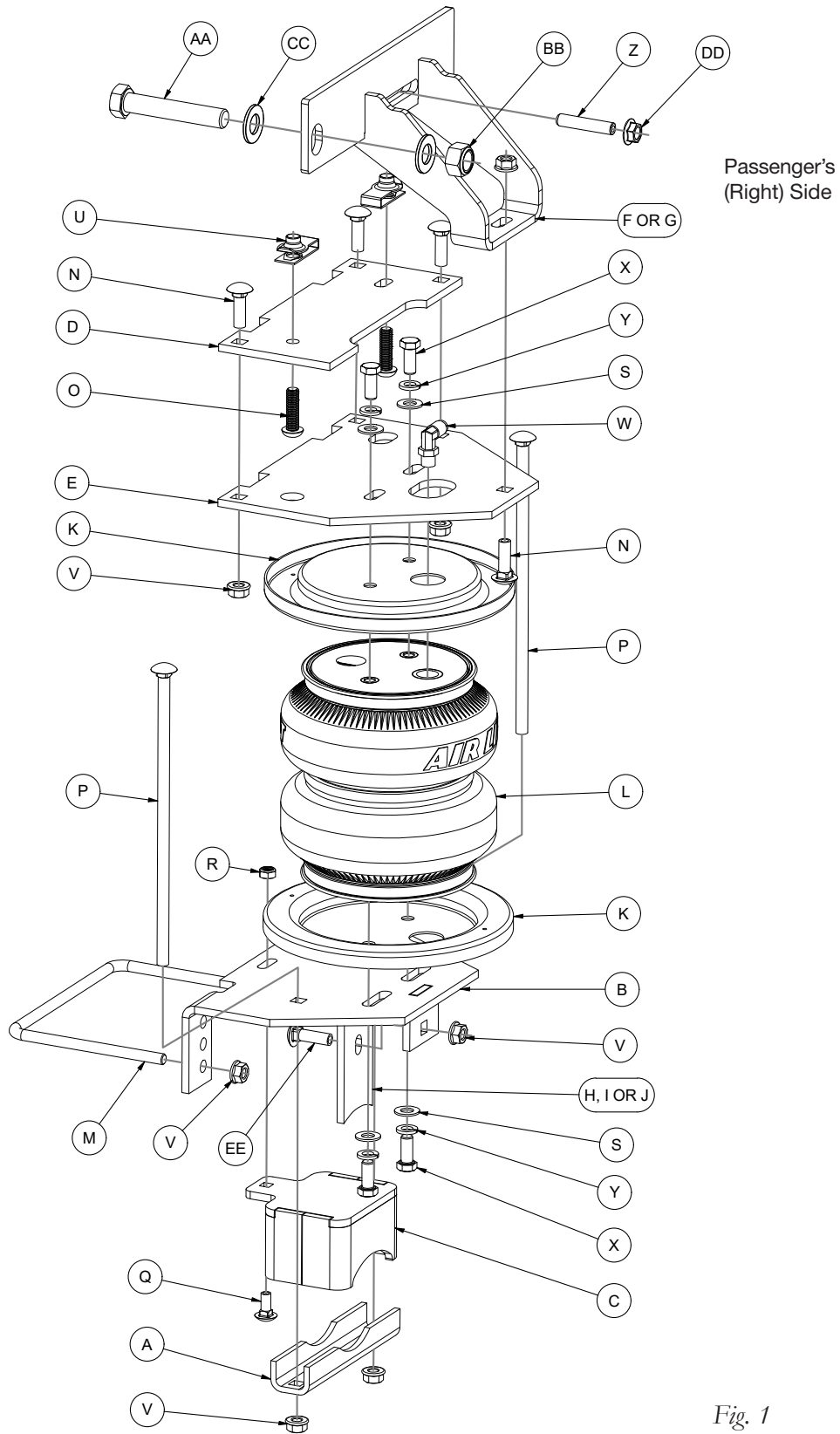

Fig. 1

Hardware and Tools Lists

HARDWARE LIST

Item	Part#	Description	Qty
A	01531	Clamp bar	2
B	03818	Lower bracket	2
C	03223	Lower bracket, cup	2
D	07974	Upper frame bracket	2
E	07925	Upper air spring bracket	2
F	07895	RH upper frame brace	1
G	07873	LH upper frame brace	1
H	03914	Lower leg adapter, F250	2
I	03917	Lower leg adapter, F350 DRW	2
J	03918	Lower leg adapter, F350 SRW	2
K	11897	Roll plate	4
L	58115	Air spring	2
M	11770	U-bolt	2
N	17361	3/8"-16 x 1 1/4" Carriage bolt	10
O	17366	M10-1.5 x 35mm Button head cap screw	4
P	17387	3/8"-16 x 10" Carriage bolt	4
Q	17500	5/16"-18 x 3/4" Carriage bolt	2
R	18404	5/16"-18 Serrated flange lock nut	2
S	18444	3/8" Flat washer	8
T*	18501	M8 Flat washer	2
U	18622	M10-1.5mm, Short universal nut	4
V	18422	3/8"-16 Serrated flange lock nut	18
W	21830	1/4" NPT x 1/4" PTC swivel 90 degree fitting	2
X	17203	3/8"-24 x 7/8" Hex bolt	8
Y	18427	3/8" Lock washer	8
Z	17525	M10 x 1.5 x 50mm Set screw	1
AA	17348	5/8"-11 x 4 1/2" Hex cap screw	3
BB	18548	5/8"-11 Nylon lock nut	3
CC	18449	5/8"-11 Flat washer	6
DD	18651	M10 x 1.5 Serrated flange lock nut	1
EE	17134	3/8"-16 x 1" Carriage bolt	2
FF*	10466	Zip ties	6
GG*	21230	Valve cap	2
HH*	21234	Rubber washer	2
II*	18411	Small star washer	2
JJ*	21233	5/16" Hex nut	4
KK*	20086	Air line assembly	1

* These parts are not shown in the Installation Diagram (Fig.1).

TOOLS LIST

Description	Qty
Metric & standard open-end box wrenches	set
Ratchet with metric and standard sockets	set
Drill and 5/16" drill bit	1
Torque wrench	1
Hex key wrenches metric and standard	set
9/16" Crows foot adapter	1
9/16" Ratchet combo wrench	1
Mid-size adjustable wrench	1
Hose cutter, razor blade or sharp knife	1
Hoist or floor jack	1
Safety stands	2
Safety glasses	1
Air compressor or compressed air source	1
Spray bottle with dish soap/water solution	1



Missing or damaged parts? Call Air Lift customer service at (800) 248-0892 for a replacement part.

Introduction

The purpose of this publication is to assist with the installation and maintenance of the LoadLifter 7500 XL air spring kit. LoadLifter 7500 XL kits utilize sturdy, reinforced, commercial-grade double-convolute bellows.

The air springs are manufactured like a tire with layers of rubber and cords that control growth. LoadLifter 7500 XL kits are recommended for most 3/4- and 1-ton pickups and SUVs with leaf springs and provide up to 7,500 pounds (3,402kg) of load-leveling support with air adjustability from 5-100 PSI (.34-7BAR).

It is important to read and understand the entire installation guide before beginning installation or performing any maintenance, service or repair.

NOTATION EXPLANATION

Hazard notations appear in various locations in this publication. Information which is highlighted by one of these notations must be observed to help minimize risk of personal injury or possible improper installation which may render the vehicle unsafe. Notes are used to help emphasize areas of procedural importance and provide helpful suggestions. The following definitions explain the use of these notations as they appear throughout this guide.



DANGER

INDICATES IMMEDIATE HAZARDS WHICH WILL RESULT IN SEVERE PERSONAL INJURY OR DEATH.



WARNING

INDICATES HAZARDS OR UNSAFE PRACTICES WHICH COULD RESULT IN SEVERE PERSONAL INJURY OR DEATH.



CAUTION

INDICATES HAZARDS OR UNSAFE PRACTICES WHICH COULD RESULT IN DAMAGE TO THE MACHINE OR MINOR PERSONAL INJURY.

Installing the System

PREPARING THE VEHICLE

1. Raise the vehicle and support it in a way, using safety stands or equivalent, that the axle can be safely dropped away from the frame. This will need to be done in order for the air spring assembly to be put into position between the axle and frame (Fig. 2).

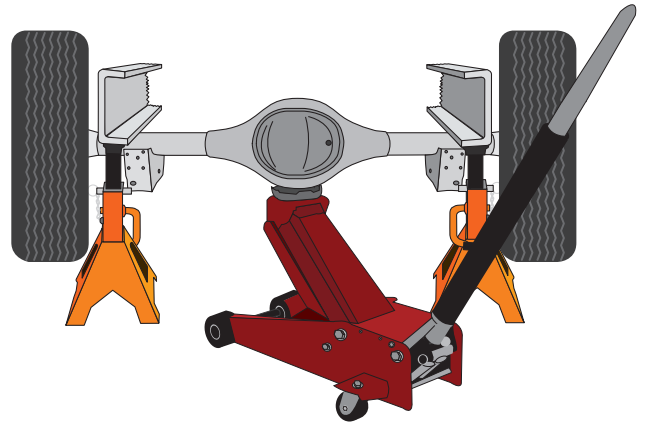

Fig. 2

INSTALLING THE UPPER FRAME BRACKETS

1. Unbolt and remove the jounce bumper assembly from under the frame on both sides (Fig. 3).



Fig. 3

2. Remove the clip-in studs by prying on the hinged end with a screwdriver to release. Pull all four clip-in studs out of the frame (Fig. 4).

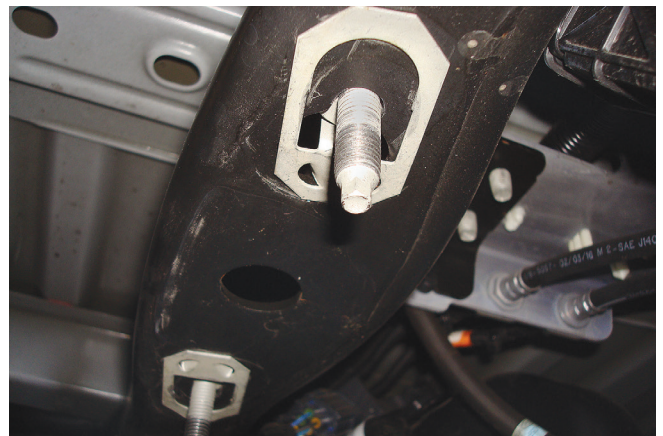

Fig. 4

3. Install the universal nuts (U) into the frame rail, lining up the holes in the frame and the threads in the nuts so that a bolt can be installed (Fig. 5).

TECH TIP

A flat-tipped screwdriver works well for installing the universal nut into position.

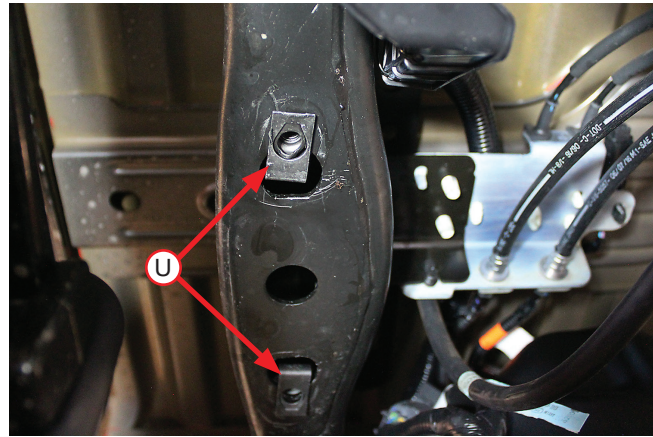

Fig. 5

4. Insert the 3/8"-16 x 1 1/4" carriage bolts (N) into the upper frame bracket (D). Install the upper frame bracket onto the frame using the M10-1.5 x 35mm button head cap screws (O) so that the large cut-out on the side of the bracket is inboard of the frame rail and the slotted hole in the center is forward (Fig. 6). Torque hardware to 38 lb.-ft. (52Nm).

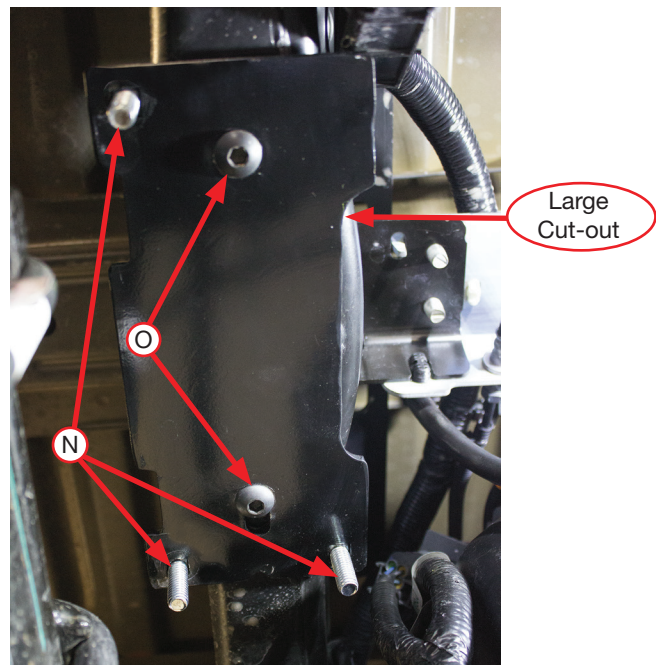

Fig. 6

AIR SPRING AND BRACKET ASSEMBLY

1. Install the swivel elbow fitting (W) into the top of the air spring finger-tight. Tighten the swivel fitting an additional one and a half turns. Place a roll plate (K) on top of the air spring (Fig. 7).

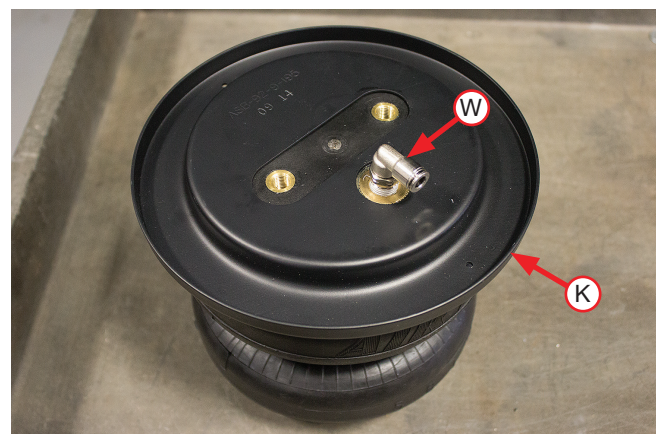

Fig. 7

- Insert 3/8"-16 x 1 1/4" carriage bolts (N) into the square holes on the brackets, then secure the upper air spring bracket (E) onto the top of the air springs using 3/8"-24 x 7/8" hex bolts (X), 3/8" lock washers (Y) and 3/8" flat washers (S). At this stage, the air spring assemblies are left- and right-hand units. Push the brackets as far forward as possible (Fig. 8). Torque the hardware to no more than 20 lb.-ft. (27Nm).

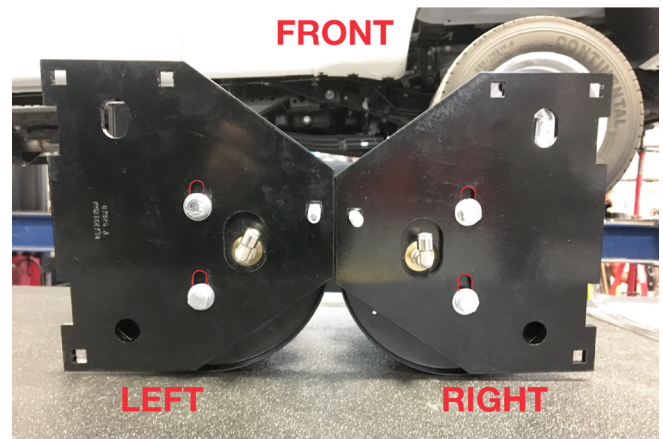

Fig. 8

- Flip the assemblies over and set a roll plate onto the bottom of the air spring (Fig. 9).



Fig. 9

- Install the lower bracket cup (C) onto the lower bracket (B) using a 5/16"-18 x 3/4" carriage bolt (Q) (Fig. 10). Cap with a 5/16"-18 serrated flange lock nut (R) (Fig. 11). Snug the bolt, but leave loose enough for the bracket to move freely in the slot.

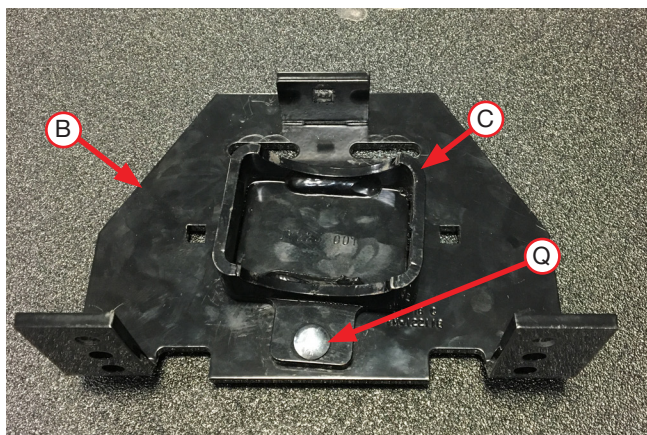

Fig. 10

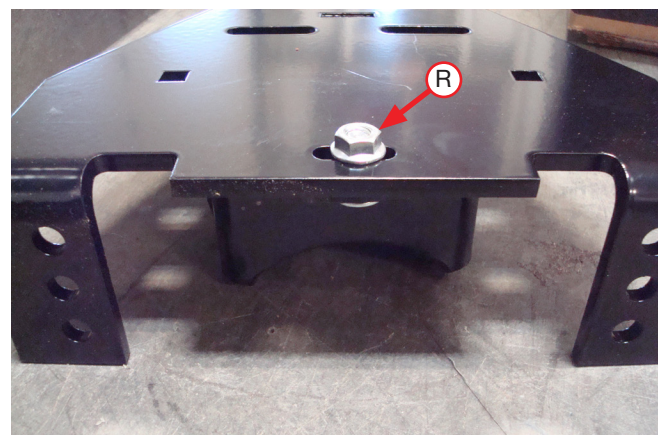

Fig. 11

5. Insert two 3/8"-16 x 10" carriage bolts (P) through the square holes in the lower bracket (B) (Fig. 12).

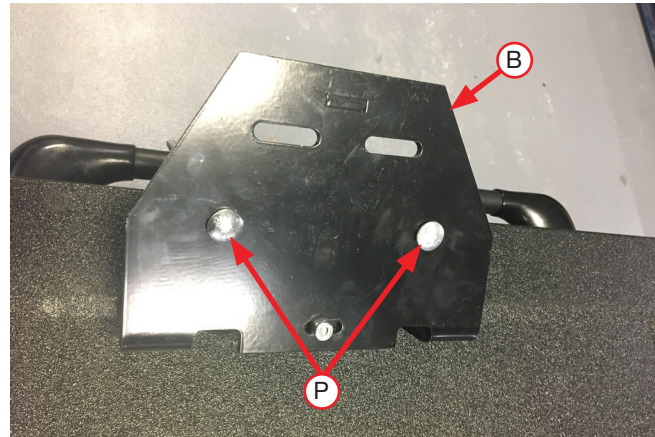

Fig. 12

6. Set the lower bracket assemblies onto the air springs with a roll plate installed and attach with two 3/8"-24 x 7/8" hex bolts (X), 3/8" lock washers (Y) and 3/8" flat washers (S) (Fig. 13). Push the lower bracket as far forward as possible. Refer to Fig. 14. Torque the hardware to no more than 20 lb.-ft. (27Nm).

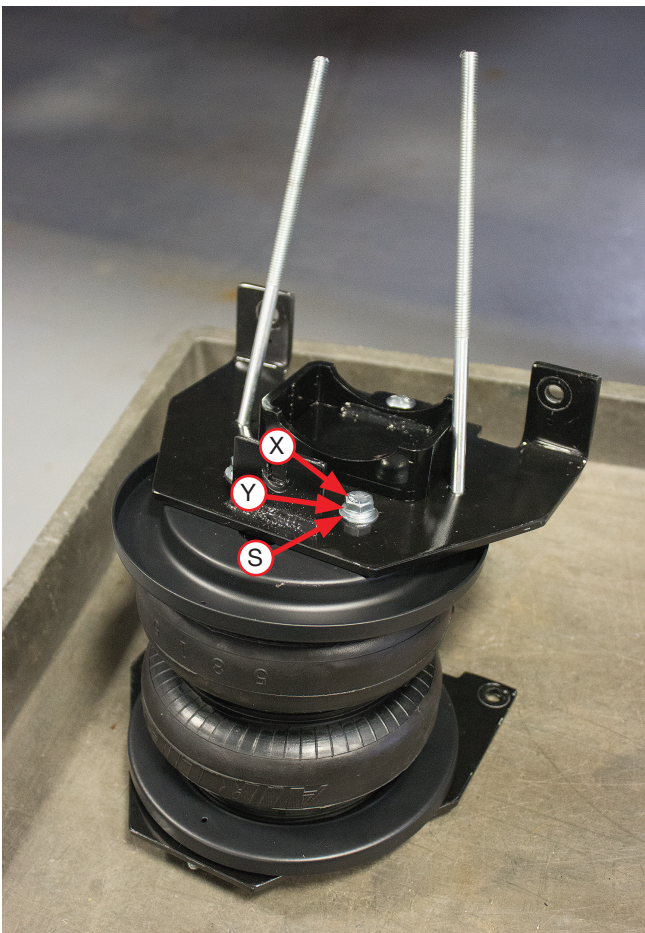

Fig. 13

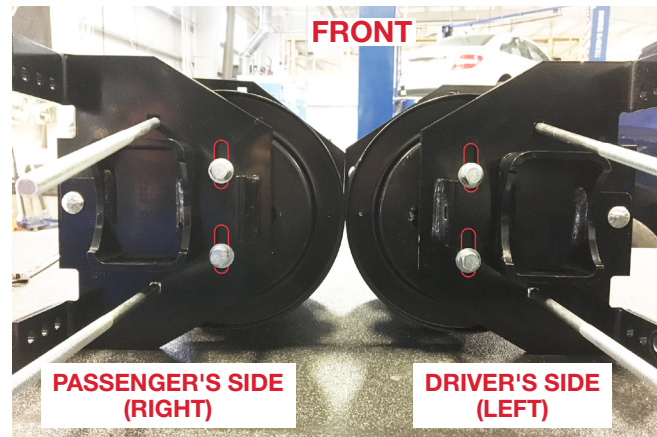

Fig. 14

- Select the appropriate lower leg adapter (H, J, I) for your vehicle, as shown in Table 1. Attach the appropriate adapter with a 3/8"-16 x 1" carriage bolt (EE) and 3/8" serrated flange lock nut (V) (Fig. 15). Install as shown (Fig. 16). Push adapter against the lower bracket and torque the hardware to 16 lb.-ft. (14Nm).

Application	Adapter Part #
F250	03914 (H)
F350 SRW	03918 (J)
F350 DRW	03917 (I)

Table 1

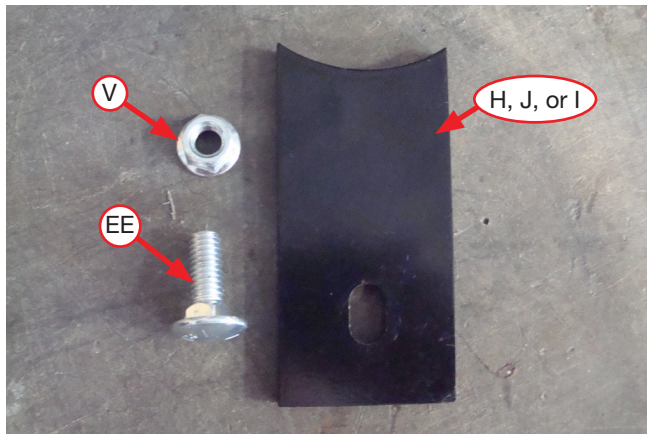

Fig. 15

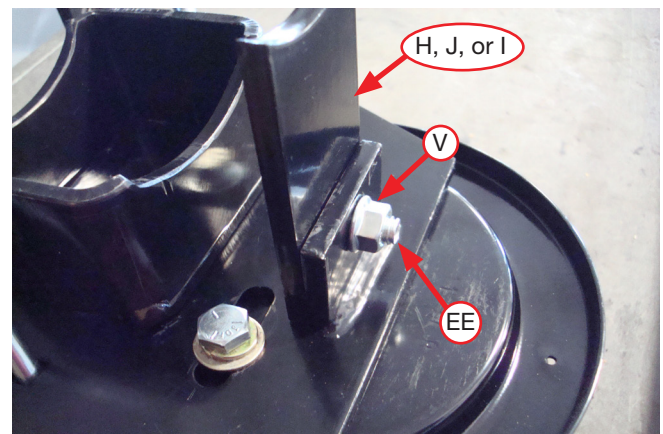

Fig. 16

- Refer to Fig. 17 for the driver's (left) and passenger's (right) side assemblies.



Fig. 17

PREPPING THE VEHICLE

F350 DRW MODELS ONLY

1. To make room for driver's (left) side bottom air spring roll plate, it will be necessary to modify the ABS/brake line bracket that is on top of the axle. To do this, first remove the ABS line Christmas tree mount from the bottom left hand side of the ABS/brake line bracket (Fig. 18).

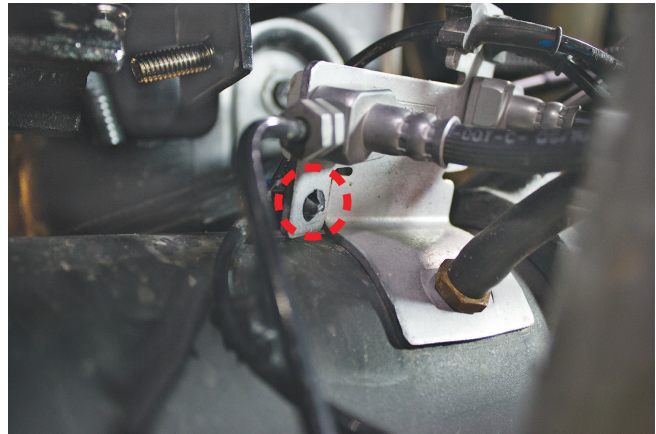

Fig. 18

2. Next, remove the ABS line from the top of the bracket by pulling it out of the slot (Fig. 19).

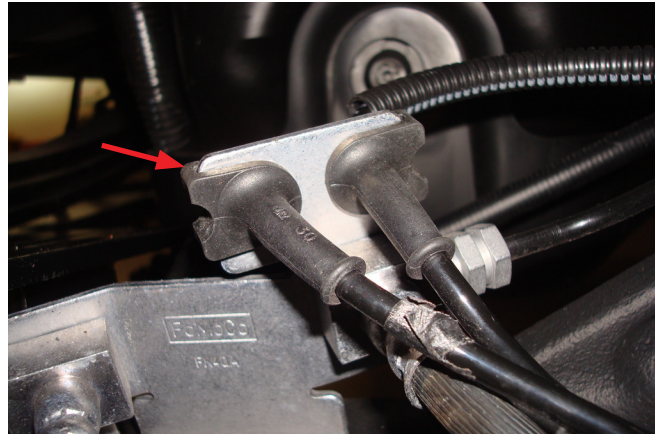

Fig. 19

3. Using an adjustable wrench, bend the top of the ABS/brake line bracket back enough to clear the roll plate (check clearance once the assembly is installed) (Fig. 20).



Fig. 20

4. Tie off the ABS line to the brake lines as shown in Fig. 21.

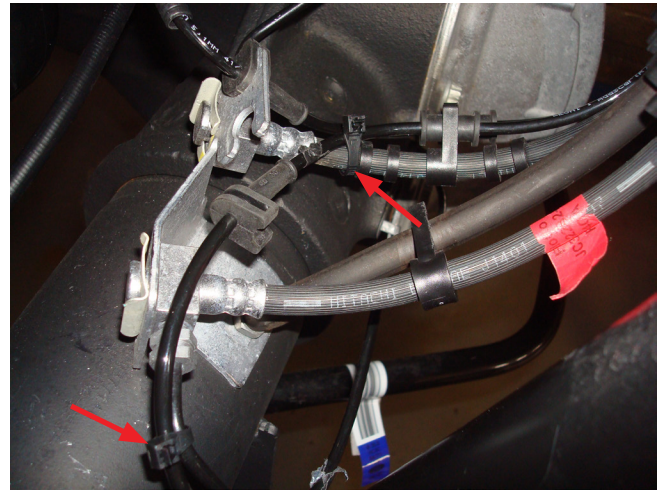

Fig. 21

ALL MODELS

1. To install the driver's (left) side upper brace (G), if equipped, remove the rearward fifth wheel bracket hardware, set aside for later use (Fig. 22).



Fig. 22

2. Locate the two M10 bolts holding the brake line bracket to the frame (Fig. 23). Unbolt both and pull the bracket away from the frame (Fig. 24).

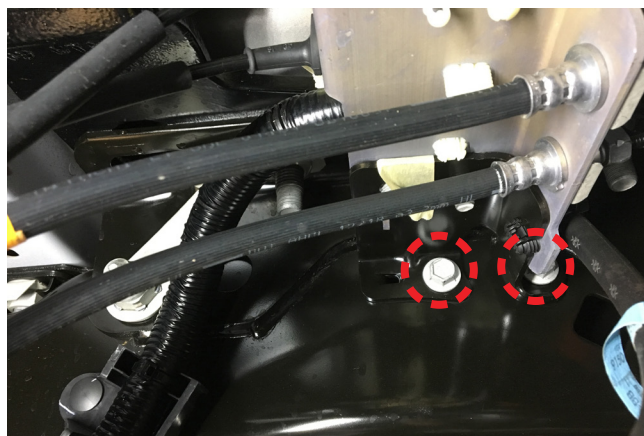

Fig. 23



Fig. 24

3. Install the set screw (Z) into the rearward threaded hole. Leave about 30mm (1.20") protruding from the frame (Fig. 25).

Fig. 25

4. Set the upper brace (G) in place over the 10mm set screw and against the frame. Ensure the hole in the rear of the brace lines up with the fifth wheel bracket hole in the frame. Set the stock brake line bracket, previously removed, over the 10mm set screw and on top of the brace. Thread the M10 serrated flange lock nut (DD) onto the set screw. Reinstall the factory fifth wheel hardware previously removed (if equipped) or use the supplied 5/8" (AA, BB, CC) hardware through the frame and brace (Fig. 26 & Fig. 27). Leave loose at this time.

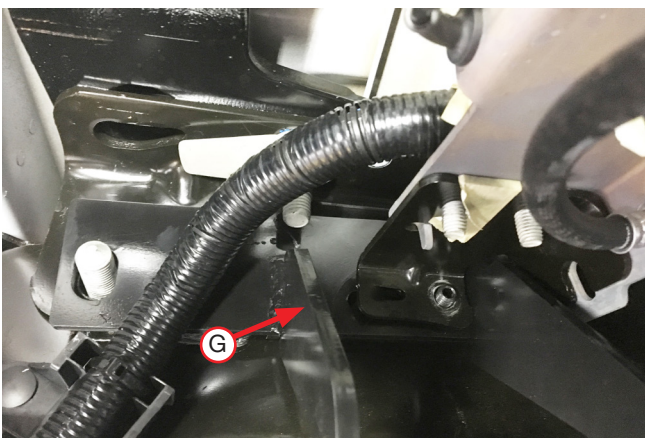

Fig. 26

Fig. 27

- To install the passenger's (right) side upper brace (F) locate the clip (blue circle Fig. 28) that holds the wiring harness for the O2 sensor. Remove and discard the clip as it will no longer be needed.

NOTE

Some models may not have the O2 sensor clip.

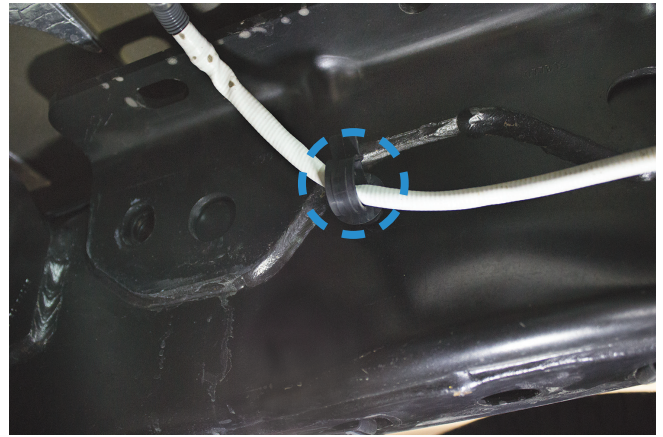

Fig. 28

- Remove the factory fifth wheel hitch hardware (if equipped), from the holes in the side of the frame. Using the existing holes in the frame, attach the upper frame brace (F) to the frame using the factory hitch hardware removed or the 5/8" (AA, BB, CC) hardware supplied (Fig. 29). Leave loose at this time.

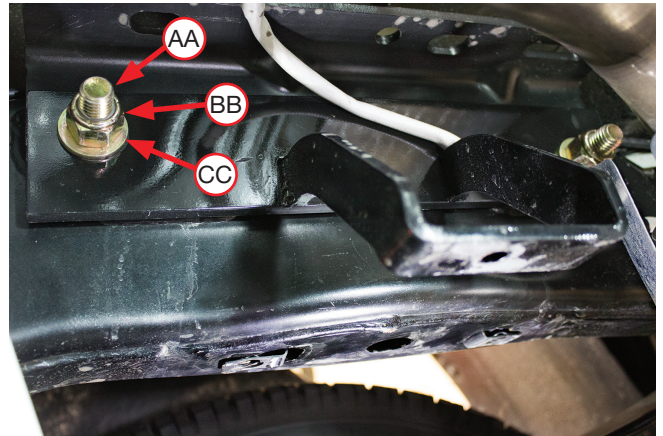

Fig. 29

INSTALLING THE AIR SPRING ASSEMBLIES

- With the vehicle supported by safety stands, drop the axle or raise the body so that the assemblies can be put into position in between the axle and frame. Set the driver's (left) side and passenger's (right) side assemblies into position so that the lower bracket cup nests on the jounce bumper strike plate for single rear wheel (SRW) or the axle for dual rear wheel (DRW) applications.

NOTE

If you have a sway bar, insert the carriage bolts through the clamp bar (A) as you set the assemblies into position over the axle (see Fig. 33).

- Once assemblies are in position on the jounce bumper strike plate or axle, push the lower bracket so that it is flush against the leaf spring stack and both flanges on the lower bracket are locked around the stock U-bolts (Fig. 30).

NOTE

The flanges need to be oriented so that they lock around the truck's existing leaf spring U-bolts.

On the driver's (left) side, the long carriage bolt in the lower bracket will be between the hard brake line and axle (Fig. 36). On the passenger's (right) side, the carriage bolt will be on the back side of the brake line (Fig. 37).

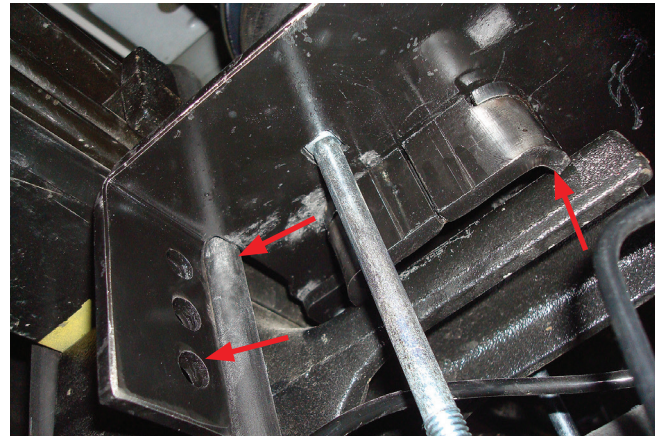

Fig. 30

- Install the U-bolts (M) around the stock leaf spring U-bolts and insert through the closest set of holes that will position the U-bolts closest to the leaf spring (Fig. 31). Cap with 3/8"-16 serrated flange lock nuts (V). Snug the bolts evenly, just tight enough to hold the lower bracket flush against the stock U-bolts.

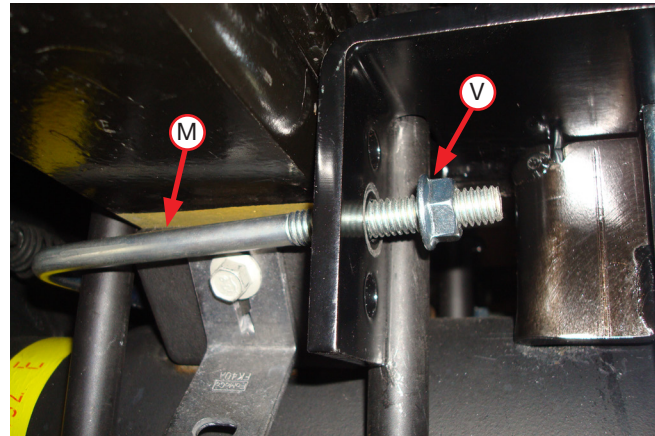

Fig. 31

- Before proceeding, ensure the 90 degree fittings are pointing inboard toward the center of the vehicle. While raising the axle or lowering the body of the vehicle, align the previously installed upper frame bracket carriage bolts (including the one on the air spring bracket) with the air spring bracket/frame brace holes so the carriage bolts protrude. Cap all the carriage bolts with the 3/8" Serrated flange lock nuts (V) (Fig. 32). Snug the bolts down first then torque to 31 lb.-ft. (42Nm).

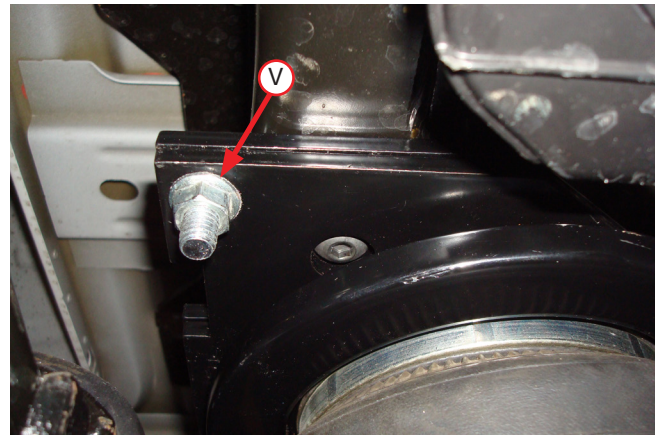

Fig. 32

- Torque the frame brace/fifth wheel 5/8" hardware supplied (AA, BB, CC if used) to 150 lb.-ft. (203Nm). If using the stock fifth wheel hardware removed, torque to 180 lb.-ft. (244Nm).
- Torque the M10 serrated flange lock nut on the driver's (left) side brace to 37 lb.-ft. (50Nm).
- Finish raising the axle or lowering the body and remove safety stands.

8. If not already completed (sway bar noted earlier), set the lower clamp bars (A) over the carriage bolts located under the axle (Fig. 33). Attach with the 3/8" serrated flange lock nut (V). Evenly torque the lower clamp bar hardware to 16 lb.-ft. (22Nm).

TECH TIP

For sway bar applications it is acceptable to tighten the front carriage bolt hardware down more than the rear to gain more clearance on the sway bar. Also, it may be necessary to use a 9/16" crows foot adapter to properly torque the hardware.

9. Finish tightening the U-bolt hardware previously snugged by torquing to 10 lb.-ft. (14Nm).
10. On vehicles that have a sway bar, it will be necessary to cut the front carriage bolt just below the nut, so it does not contact the sway bar (Fig. 34).

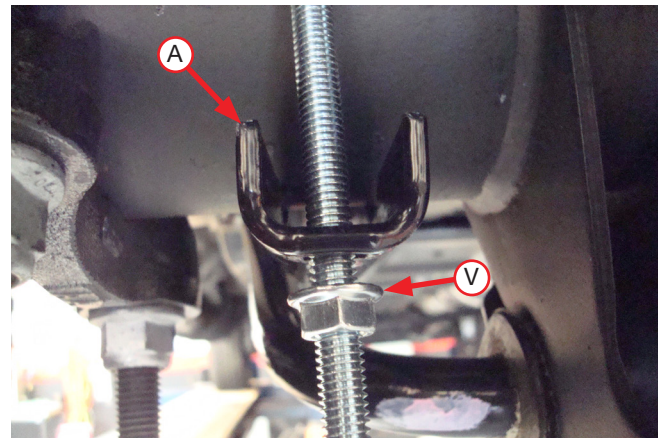

Fig. 33



Fig. 34

11. Snug the serrated flange lock nut (R) that holds the lower bracket main plate and lower bracket cup together to finish the lower bracket installation (Fig. 35).

NOTE

This nut will be difficult to tighten. It may be necessary to flip the wrench over a couple of times and/or move from the front/back side of the axle to get this tightened.



Fig. 35

12. Fig. 36 and Fig. 37 show the lower bracket installed (DRW application shown).

Driver's (left) side lower assembly

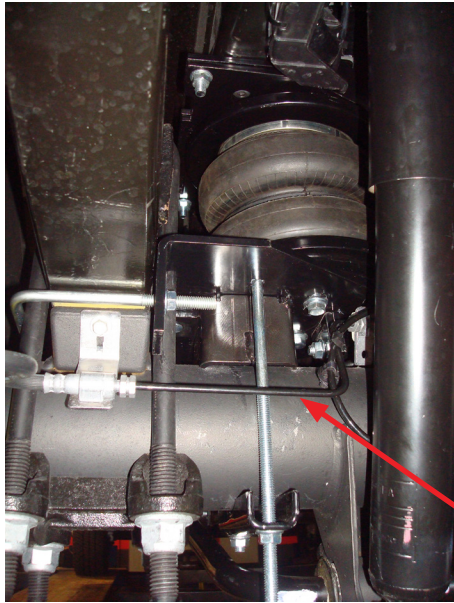

Fig. 36

Passenger's (right) side assembly



Fig. 37

If the hard brake line is resting on the lower bracket carriage bolts on either side, push or pull the brake line out of the way.

13. The axle vent tube will also have to be zip tied to one of the brake soft lines in order to keep it out of the way of the air spring assembly (Fig. 38 & Fig. 39).

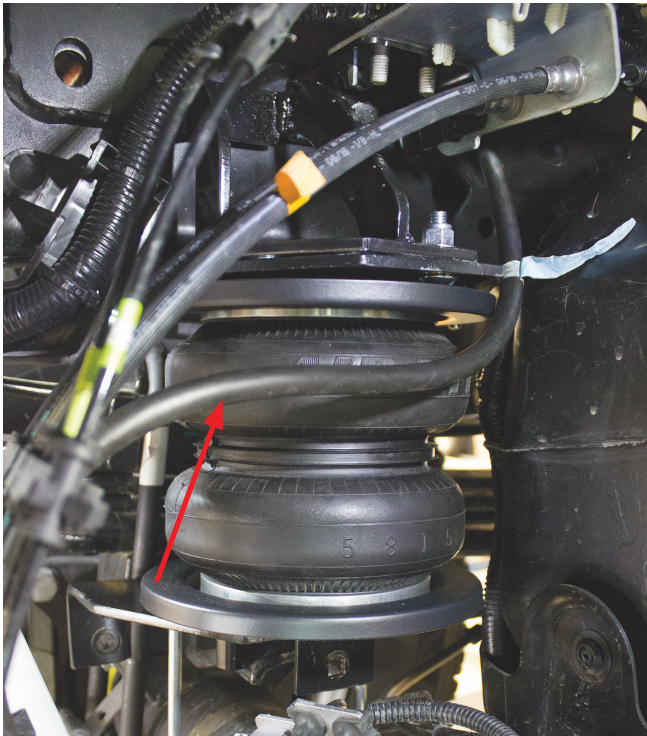

Fig. 38



Fig. 39

Installing the Air Lines

1. Choose the locations for the Schrader valves and drill a 5/16" (8mm) hole, if necessary (Fig. 40).
2. Cut the air line in half. Make clean, square cuts with a razor blade or hose cutter (Fig. 41). Do not use scissors or wire cutters.

CAUTION

KEEP AT LEAST 6" (152MM) OF CLEARANCE BETWEEN ALL AIR LINES AND THE EXHAUST SYSTEM. AVOID SHARP BENDS AND EDGES.

3. Use zip ties to secure the air line to fixed points along the chassis. Do not pinch or kink the air line. Leave at least 2" (51mm) of slack in the air line to allow for any movement that might pull on the air line. The minimum bend radius for the air line is 1" (25mm).
4. Install the Schrader valve in the chosen location (Fig. 42).

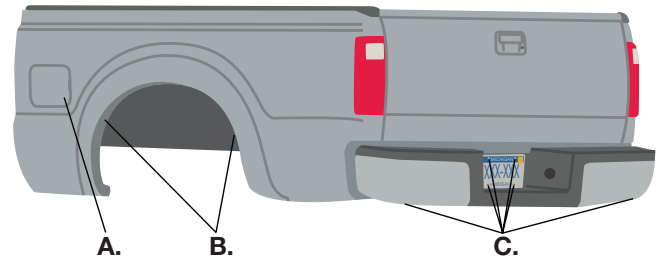

A. Inside fuel tank filler door
 B. Inside rear wheel wells
 C. License plate or rear bumper area

Fig. 40

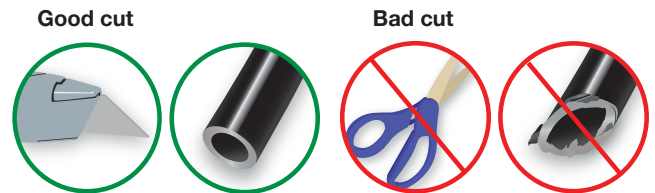

Fig. 41

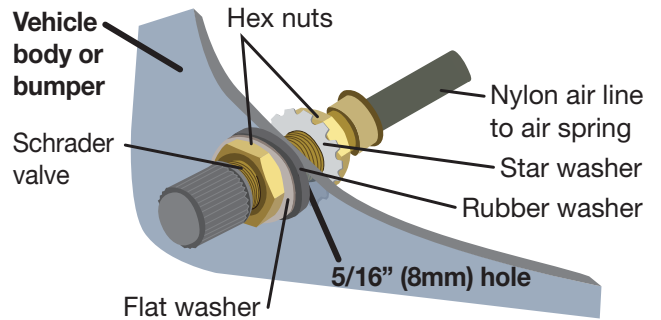

Fig. 42

INSTALLING THE HEAT SHIELD

1. Attach the metal heat shield to the exhaust where it is closest to the air spring. Slide the air line thermal sleeve over the air line and place it where the air line is closest to the exhaust (Fig. 43).

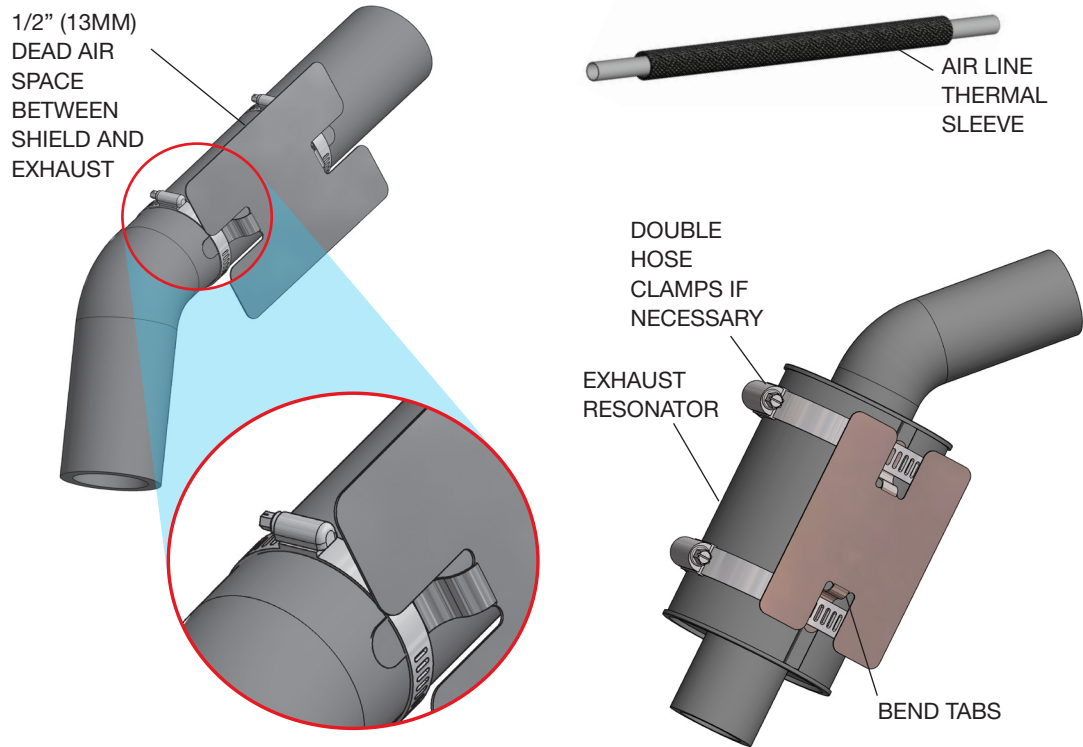
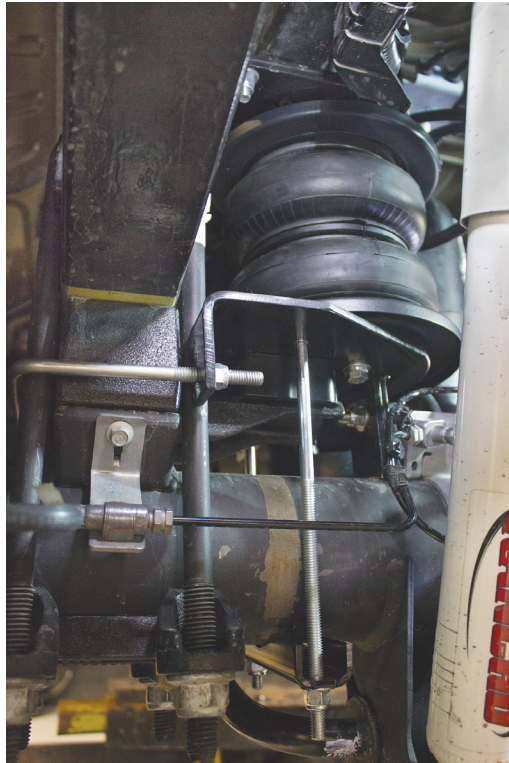

Fig. 43

FINISHED INSTALLATION PHOTOS

1. The following images show the finished installation of both sides for F250 & F350 SRW applications (Figs. 44-47).



Driver's (left) side installation from the rear *Fig. 44*



Driver's (left) side installation from the middle *Fig. 45*

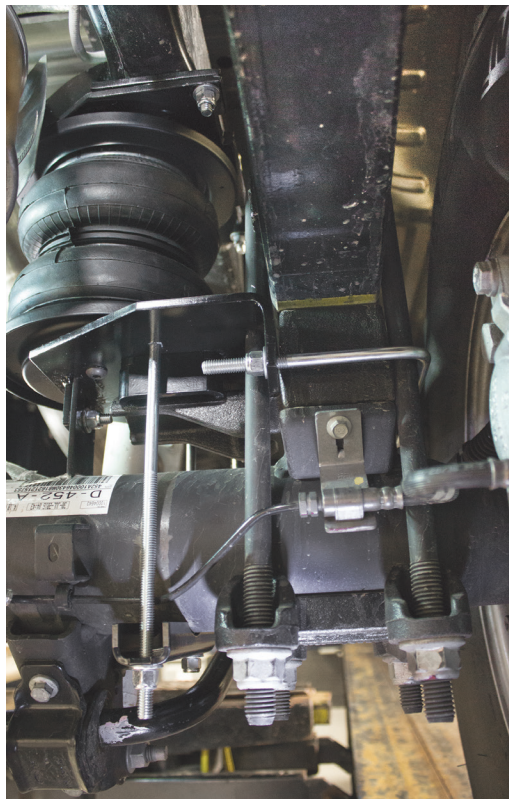

Passenger's (right) side installation from the rear *Fig. 46*



Passenger's (right) side installation from the middle *Fig. 47*

2. The following images show the finished installation of both sides for F350 DRW application (Figs. 48-51).

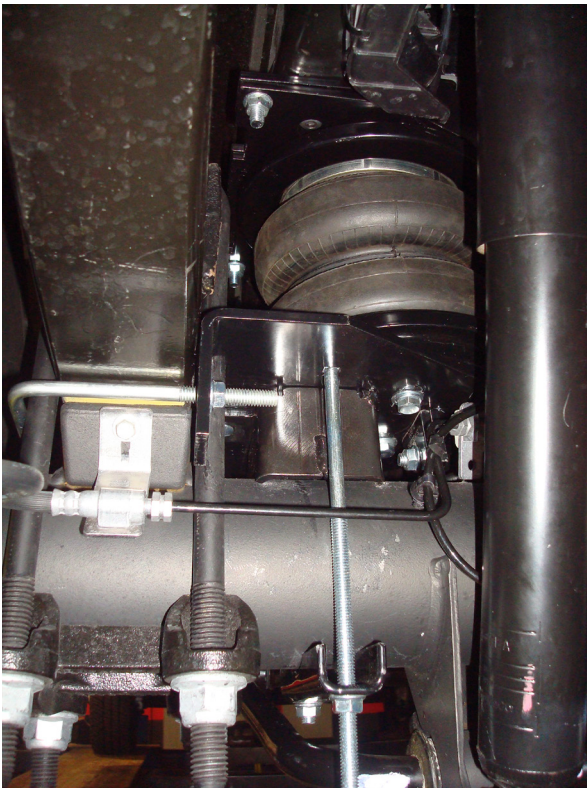

Driver's (left) side installation from the rear

Fig. 48



Driver's (left) side installation from the middle

Fig. 49

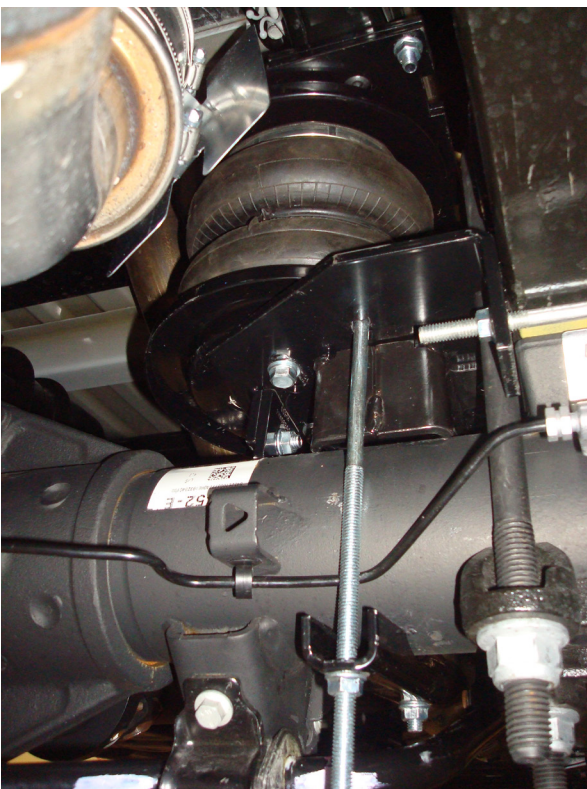

Passenger's (right) side installation from the rear

Fig. 50

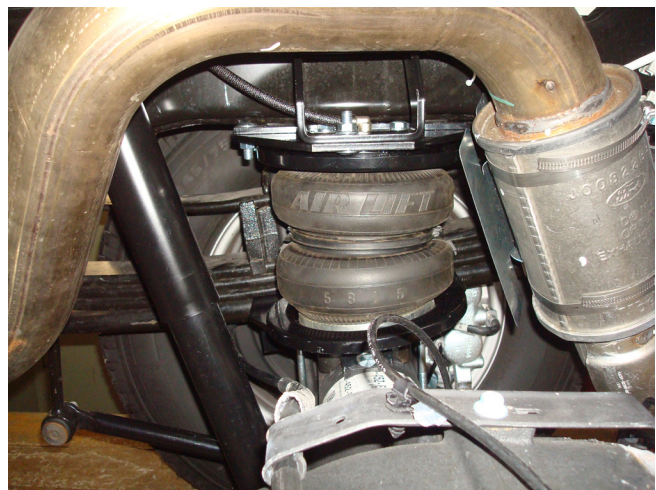

Passenger's (right) side installation from the middle

Fig. 51

INSTALLATION CHECKLIST

- Clearance test** — Inflate the air springs to 40-60 PSI (2.8-4.1BAR) and make sure there is at least 1/2" (13mm) clearance from anything that might rub against each air spring. Be sure to check the tire, brakes, frame, shock absorbers and brake cables.
- Leak test before road test** — Inflate the air springs to 40-60 PSI (2.8-4.1BAR) and check all connections for leaks. All leaks must be eliminated before the vehicle is road tested.
- Heat test** — Be sure there is sufficient clearance from heat sources, at least 6" (152mm) for air springs and air lines. If a heat shield was included in the kit, install it. If there is no heat shield, but one is required, call Air Lift customer service at (800) 248-0892.
- Fastener test** — After 500 miles (800km), recheck all bolts for proper torque.
- Road test** — The vehicle should be road tested after the preceding tests. Inflate the air springs to recommended driving pressures. Drive the vehicle 10 miles (16km) and recheck for clearance, loose fasteners and air leaks.
- Operating instructions** — If professionally installed, the installer should review the operating instructions with the owner. Be sure to provide the owner with all of the paperwork that came with the kit.

MAINTENANCE AND USE GUIDELINES

1. Check air pressure weekly.
2. Always maintain normal ride height. Never inflate beyond 100 PSI (7BAR).
3. If the system develops an air leak, use a soapy water solution to check all air line connections and the inflation valve core before deflating and removing the air spring.

Minimum Recommended Pressure
5 PSI (.34BAR)

Maximum Air Pressure
100 PSI (7BAR)

CAUTION

FOR SAFETY AND TO PREVENT POSSIBLE DAMAGE TO THE VEHICLE, DO NOT EXCEED MAXIMUM GROSS VEHICLE WEIGHT RATING (GVWR) OR PAYLOAD RATING, AS INDICATED BY THE VEHICLE MANUFACTURER.

ALTHOUGH THE AIR SPRINGS ARE RATED AT A MAXIMUM INFLATION PRESSURE OF 100 PSI (7BAR), THE AIR PRESSURE ACTUALLY NEEDED IS DEPENDENT ON LOAD AND GROSS VEHICLE WEIGHT RATING.

LIMITED WARRANTY AND RETURN POLICY

Air Lift Company provides a limited lifetime warranty to the original purchaser of its load support products, that the products will be free from defects in workmanship and materials when used on cars and trucks as specified by Air Lift Company and under normal operating conditions, subject to the requirements and exclusions set forth in the full Limited Warranty and Return Policy that is available at www.airliftcompany.com/warranty.

For additional warranty information contact Air Lift Company customer service.



Thank you for purchasing Air Lift Products — the Authorized Installer's choice!

Need Help?

Contact Air Lift Company Customer Service at (800) 248-0892
or email service@airliftcompany.com.

For calls outside the U.S. or Canada, dial (517) 322-2144.



MADE IN USA
WITH GLOBAL
COMPONENTS

Air Lift Company • 2727 Snow Road • Lansing, MI 48917 or P.O. Box 80167 • Lansing, MI 48908-0167

Air Lift Company reserves the right to make changes and improvements to its products and publications at any time.
For the latest version of this manual, contact Air Lift Company at (800) 248-0892 or visit airliftcompany.com.