

RTS36DG/RTS37DG

# MAGNUM RT STEPS

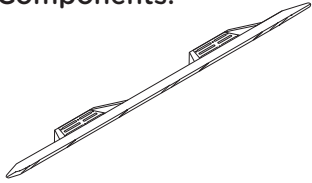

## Components:



Passenger Side Step Bar Qty 1

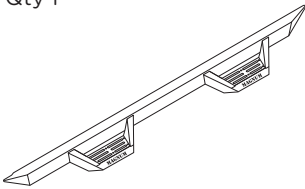

Driver Side Step Bar Qty 1

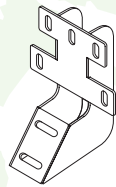

Mounting Brackets Qty 6

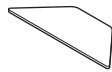

Front Armor Plates Qty 2

## Hardware:



M8 x 30MM Hex Head Bolts Qty 6

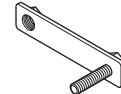

RTSPN175 Bolt/Nut Plates Qty 6



M8 Hex Head Nuts Qty 24



M8 Plastic Push Nuts Qty 6



M8 Flat Washers Qty 30



M8 Lock Washers Qty 30

## Tools Required:

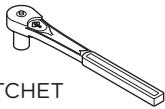

RATCHET



TORQUE WRENCH



13MM SOCKET

## Torque Specifications:

For Rocker Panel Mount Installations  
M8 through M12 bolts and nuts are set to 15-20 ft lbs.

**Note: When installing the brackets and bars, all hardware must be left loose until all the items are attached.**

**1.** Remove all contents from the package and check steps for any damage. Also, verify that all components and hardware listed above are included before you begin installation.

**2.** Begin on driver side of vehicle and align the Front, Center and Rear brackets as shown.

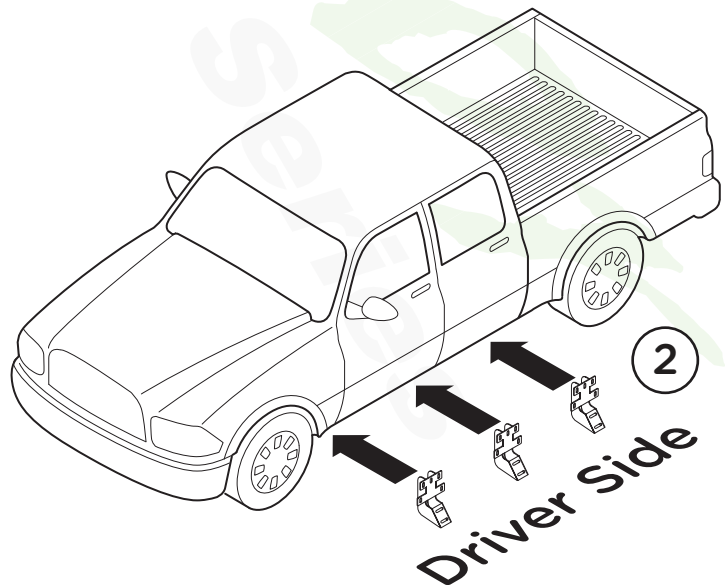

**3.** Existing mounting studs are located on the interior wall of the rocker panel. These mounting studs will be used for the following instruction.

**Note:** Mounting studs may be painted and need to be cleaned with an M8-1.25 die before the M8 Hex Head Nut will properly thread. Do not try to force thread the nut on the stud as this could strip the nut.

**4.** Position each bracket onto the existing mounting studs on the rocker panel (4a). Fasten by using three (3) M8 Flat Washers, three (3) M8 Lock Washers and three (3) M8 Hex Head Nuts per bracket (4b).

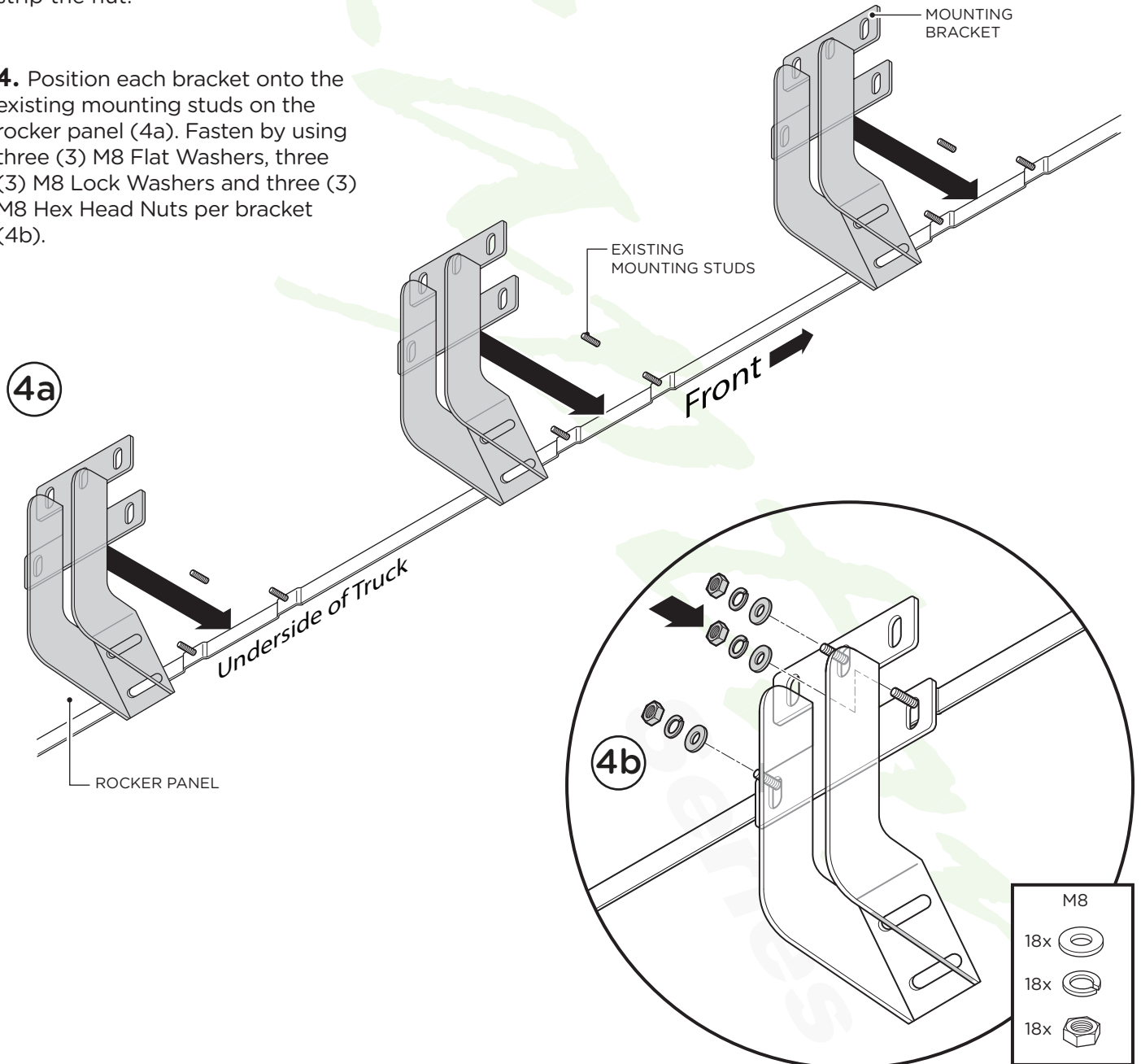

## Installing the Step Bar

**5.** Line up mounting points on the step bar with the mounting holes in each bracket.

**6.** Fasten the step bar to each bracket using one (1) RTSPN175 Bolt/Nut Plate, one (1) Plastic Push Nut, one (1) M8 Hex Head Nut, two (2) M8 Lock Washers, two (2) M8 Flat Washers and one (1) M8 x 30MM Hex Head Bolt. two (2) M8 Hex Head Nuts.

**7.** Adjust the bars front/back and up/down to desired placement. Once you have the step positioned, tighten until the split lock washer is flat between the bolt head and flat washer. Do not over tighten.

**8.** When all hardware is in place, everything must be tightened. See page 1 for torque specifications. Repeat these steps for opposite side installation.

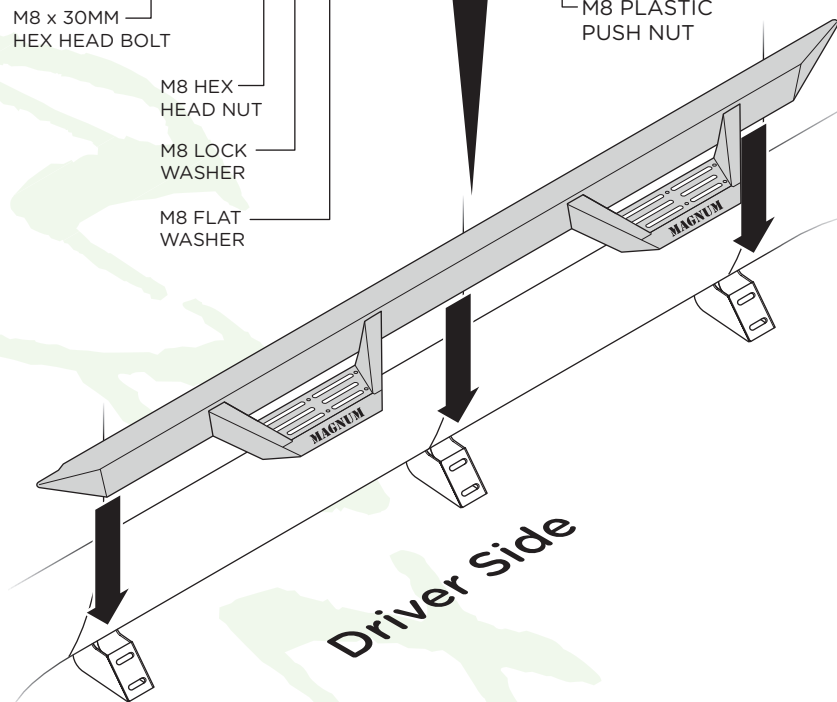
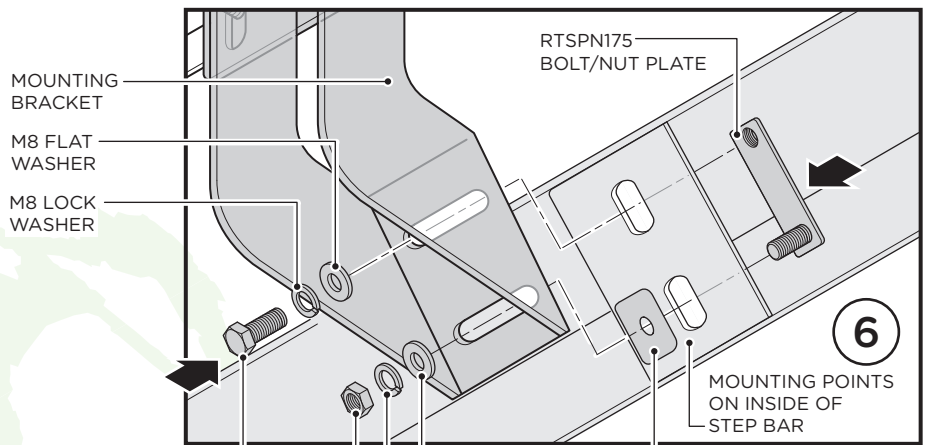

### OPTIONAL:

If you wish to install the Front Armor Plates, begin by thoroughly cleaning the front side of the front step where the Front Armor Plate will attach.

**1.** Remove adhesive protection from the Front Armor Plate.

**2.** Carefully line up with the front side of the front step. Be careful not to let the side overhang as they could peel off over time.

Once lined up, firmly press the Front Armor Plate on the step to ensure complete adhesion.

Repeat these steps for opposite side.

