

<THESE INSTRUCTIONS MUST BE GIVEN TO THE END USER>



B&W Trailer Hitches
 1216 Hawaii Rd / PO Box 186
 Humboldt, KS 66748
 P:800.248.6564
 F:620.869.9031

Call or Email us for
 Installation Support
 hitches@turnoverball.com
 bwtrailerhitches.com

Custom 5th Wheel Hitch Mounting Rail Installation Instructions

MODEL 2402

See Limited Lifetime Warranty at
bwtrailerhitches.com/warranty

2017 - 2021 Ford F250 & F350 Trucks

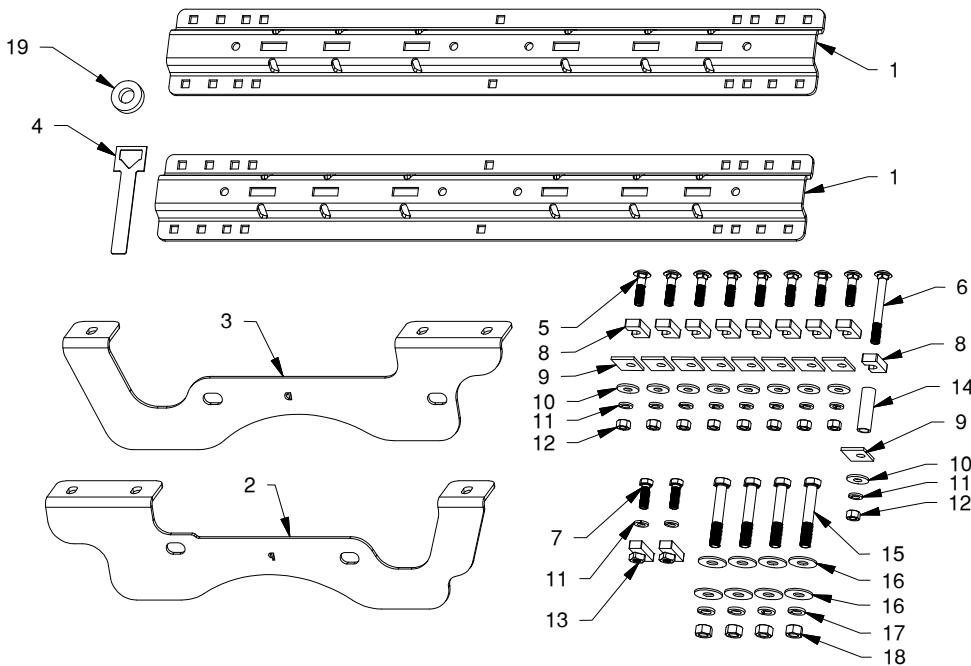

PARTS LIST		
ITEM	DESCRIPTION	QTY
1	Mounting Rail (Separate Box)	2
2	Frame Bracket, Passenger	1
3	Frame Bracket, Driver	1
4	Hardware Tool	1
5	1/2" X 2" Carriage Bolt	8
6	1/2" X 4-1/2" Carriage Bolt	1
7	1/2" X 1-1/2" Cap Screw	2
8	1/2" U-Shaped Spacer	9
9	Offset Rectangle Washer	9
10	1/2" Flat Washer	9
11	1/2" Lock Washer	11
12	1/2" Finish Nut	9
13	Threaded Spacer Block	2
14	Tube Spacer	1
15	5/8" X 4" Cap Screw	4
16	5/8" Flat Washer	8
17	5/8" Lock Washer	4
18	5/8" Finish Nut	4
19	1/2" Polypropylene Tape	1

⚠ WARNING Failure to comply with the safety information in these instructions could result in serious injury or death.

- ⚠ Read all installation and operating instructions along with all labels before using this product.
- ⚠ Adding components to the chassis of any vehicle can be hazardous. There is potential for damage to vehicle, injury from tool usage and many other hazards. This installation must be completed by someone who is aware of the hazards involved. This person must be knowledgeable of proper safety procedures for a vehicle installation of this nature, and for usage of the equipment required to perform the installation.
- ⚠ Without proper knowledge, towing can be a dangerous activity. Understand all the risks involved with towing before proceeding. For information on towing safety, see **"The Trailer Handbook: A guide to Understanding Trailer and Towing Safety"** from the *National Association of Trailer Manufacturers*, www.NATM.com and your trailer manufacturer's owner's manual.
- ⚠ Do not exceed tow or tongue rating of coupler, tow or tongue rating of hitch, or tow or weight ratings of truck or trailer. See vehicle and trailer manufacturer information for ratings. Exceeding these ratings may cause damage to towing components or loss of attachment between the trailer and truck.
- ⚠ Additional caution must be used when towing a wedge car trailer. Towing stability greatly depends on keeping the center of gravity as low as possible. Load heavy cars over the axles. Never tow with a single car on the front of the trailer. When towing a wedge car trailer, never exceed speeds that are reasonable for the roadway conditions (e.g. turns, going around a curve, etc.). Failure to account for proper trailer center of gravity and speeds that are reasonable for the roadway conditions may cause damage to the truck, trailer, towing components, and loss of attachment between the truck and trailer.
- ⚠ Do not modify this product in any manner. Doing so could alter its integrity and lead to a loss of attachment between the trailer and the tow vehicle.
- ⚠ A visual inspection of the hitch should be performed before each time you tow. Regularly check that all pinned connections are secure, and that all bolted connections are at the correct torque specification. Check for cracks or damage to the hitch. Do not tow with the hitch if cracks or damage outside of normal wear is found. Towing with a hitch that has cracks or damage could result in damage to the tow vehicle, trailer, towing components or loss of attachment between the tow vehicle and trailer.

PREPARING TO INSTALL

NOTICE: If truck is equipped with a removable bed liner or mat, it should be removed or it must be cut to allow the mounting rails to connect directly with the bed. It is acceptable to install the mounting rails over a spray in bed liner.

- Review parts and tools.** Remove all parts from the packaging and familiarize yourself with all the parts and tools required. Use the parts list on the front page to verify that all parts and hardware are present.

Installation of the mounting rails requires several common tools and a few specialized tools. Below is a listing of equipment used during a typical installation.

- Impact Wrench or Ratchet with 15/16" & 3/4" sockets
- 15/16" and 3/4" Box End Wrench
- A Drill and 1/8" & 9/16" and 7/8" Drill Bits
- Patriot 5th Wheel or Slider Base
- Hammer
- Flashlight
- Tape Measure
- Eye Protection
- Ear Protection
- Torque Wrench
- Center Punch

- Add Polypropylene tape to kit components.** As an added layer of protection between the aluminum body of the bed and the steel components of this kit a roll of polypropylene tape is included in the mounting kit box. Apply the tape, as shown below, to the components that will contact the bed of the truck.

- **Mounting Rails:** Apply four strips along the bottom of the entire length of both rails. Take care not to cover any of the holes, see Figure A1.

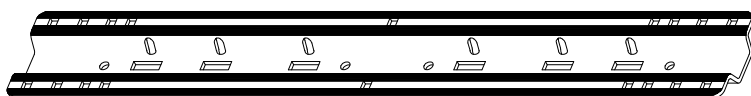

Figure A1

- **Frame Brackets:** Apply tape to the outside edge of each flange as shown in Figure A2.

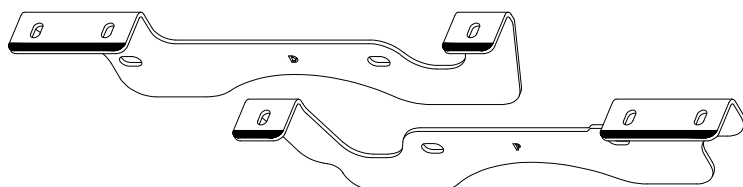

Figure A2

- **1/2" U-Shaped Spacer, Offset Rectangle Washer and Threaded Spacer Block.** Apply tape to washers as needed when they are mounted against the bed, see Figure A3 for reference.

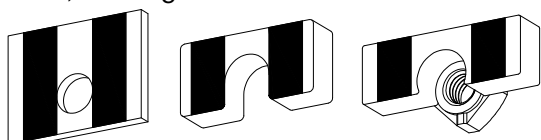

Figure A3

NOTICE: Galvanic corrosion information.

B&W recommends that the installer references Ford SVE Bulletin Q-222R1 for attaching accessories to aluminum panels and structure. It can be found at www.fleet.ford.com/truckbbas.

DRILL REAR MOUNTING HOLES

- Layout the rear mounting rail.** Place a mounting rail onto the bed of the truck. Hook a tape measure over the rear edge of the bed (not on any part of the tailgate), measure the location for the mounting rail as shown in Figure B1. Next, center the mounting rail in the bed by measuring the distance on either side from the edge of the rail to the sides of wheel wells. The rail will be centered when both measurements on either side of the rail are the same.

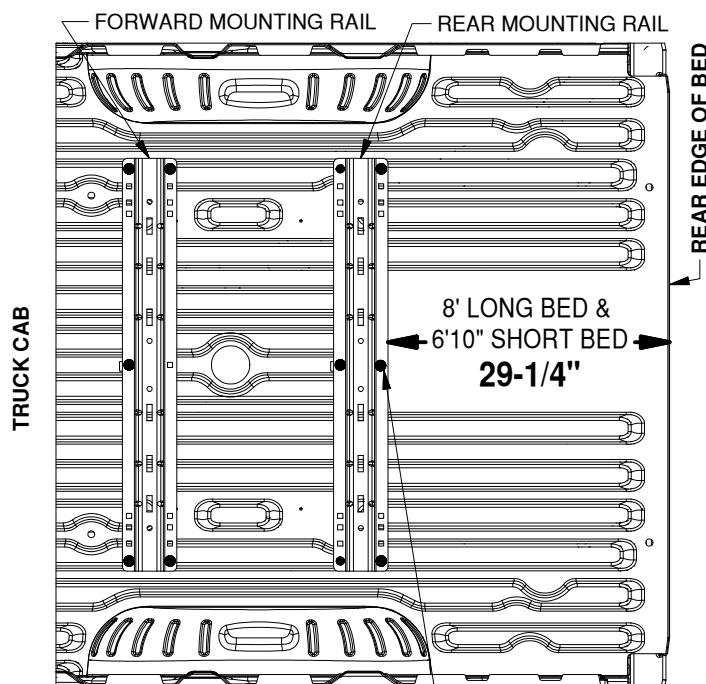

Figure B1: Detail view over bed, showing drill locations for the forward and rear bed rails.

IMPORTANT: The mounting rail is designed to install only at the described location. Failure to place the mounting rail precisely may result in added difficulty during installation and/or property damage.

- Mark hole locations.** While carefully ensuring the mounting rail does not move, use a center punch tool to mark the 6 drill locations on the rear rail. See Figure B1 for hole marking locations for this installation (forward rails will install on a later step). Once all 6 rear rail locations are clearly marked, move the bed rail out of the way and drill each location with an 1/8" drill bit.

WARNING: The fuel tank of the truck may be directly below the area of the bed which needs to be drilled. Always carefully examine the area under the truck where modification will occur. Make certain that the tank, or other equipment, is not damaged during drilling. Damage to the tank may result in property damage, serious injury or death.

3. **Check hole locations.** Using the frame brackets, align each bracket to the side of the frame where the brackets will be installed, see Figures B3 & B4. Check that the 1/8" holes are centered within the slots in the frame brackets. If the 1/8" drilled holes are not centered re-drill the 1/8" holes until the brackets and the drilled holes are aligned.

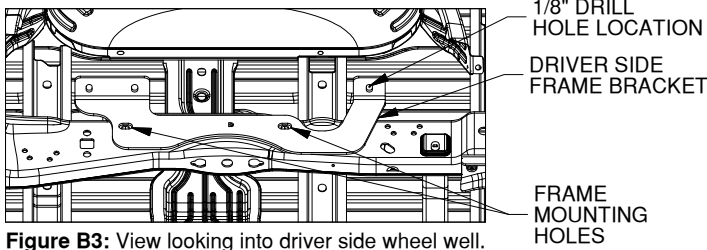

Figure B3: View looking into driver side wheel well.

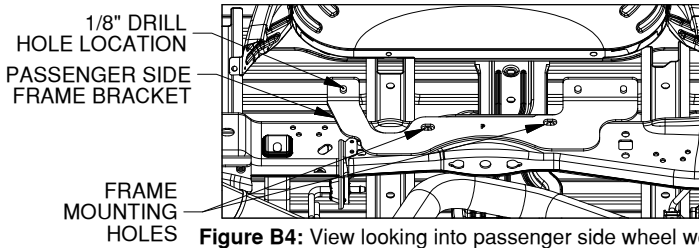

Figure B4: View looking into passenger side wheel well.

4. **Enlarge the holes.** Using the 1/8" holes as pilots, drill out each hole with a 9/16" bit. The center forward drill location on the rear rail is directly above a bed crossmember. This hole location will receive a 1/2" X 4-1/2" carriage bolt, see Figure D1. The drill must pass through both the bed and the crossmember, at this location, and should be as straight as possible when drilled. Enlarge this hole to 7/8" in the bed only.

INSTALL FRAME BRACKETS

1. **Install the frame brackets.** Locate two 5/8" x 4" cap screws and two 5/8" washers. Pass the cap screws with the flat washers through the frame bracket and the frame. Secure the frame bracket on the inside of the frame with two 5/8" flat washers, 5/8" lock washers, and 5/8" finish nuts, as shown in Figures C1 & C2. Do not tighten the mounting hardware at this time.

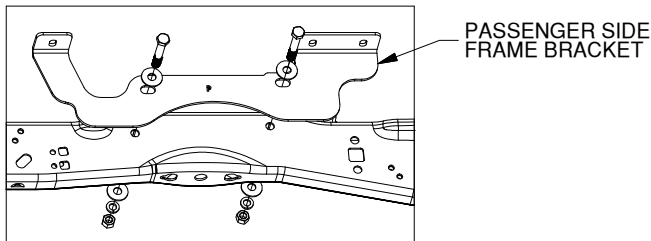

Figure C1: Frame bracket installation on passenger side of frame.

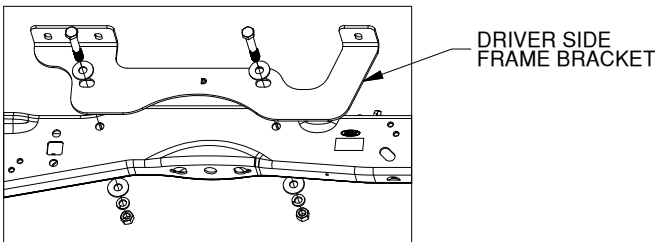

Figure C2: Frame bracket installation on driver side of frame.

INSTALL REAR MOUNTING RAIL

NOTICE: Due to the corrugation in the truck bed, U-shaped spacers are provided to function as space fillers between the mounting rails and the kit attachment hardware. Always place a u-shaped spacer in the gap either above the bed (between the mounting rail and the bed) or below the bed (between the bed and the side mounting brackets). Failure to use u-shaped spacers will result in property damage when hardware is tightened.

1. **Install the rear mounting rail.** The rear mounting rail requires three different fasteners, as shown in Figure D1. Start by placing the tube spacer into the 7/8" drilled hole in the bed, then re-position the rear mounting rail over the drilled 9/16" holes.

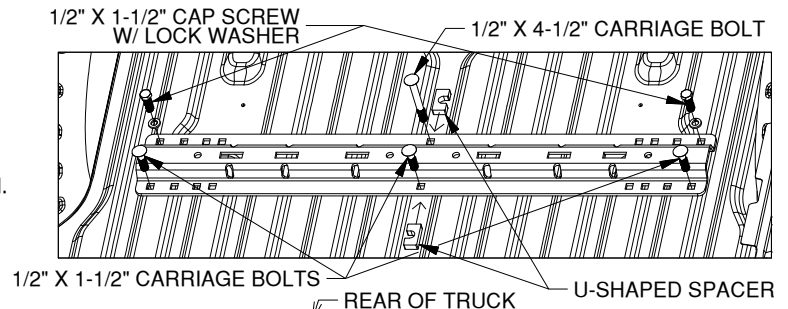

Figure D1: View looking into truck bed from rear of truck.

2. **Install the 1/2" cap screws (two places).** Locate two 1/2" x 1-1/2" cap screws, 1/2" lock washers, threaded spacer blocks and the hardware tool. Use the hardware tool to hold the threaded spacer block and insert the threaded spacer block into the bed cross member below the drilled 9/16" hole, see Figure D2. From the top of the bed, place a 1/2" cap screw and 1/2" lock washer into the mounting rail and through the bed, as shown in Figure D1. Thread the cap screw into the threaded spacer block until the block is firmly against the bottom of the bed. Ensure that the spacer block is in line with the corrugations of the bed and will not deform the bed when tightened. The hardware tool can be bent if needed to aid in positioning the threaded spacer block. Repeat the process on both sides of the truck.

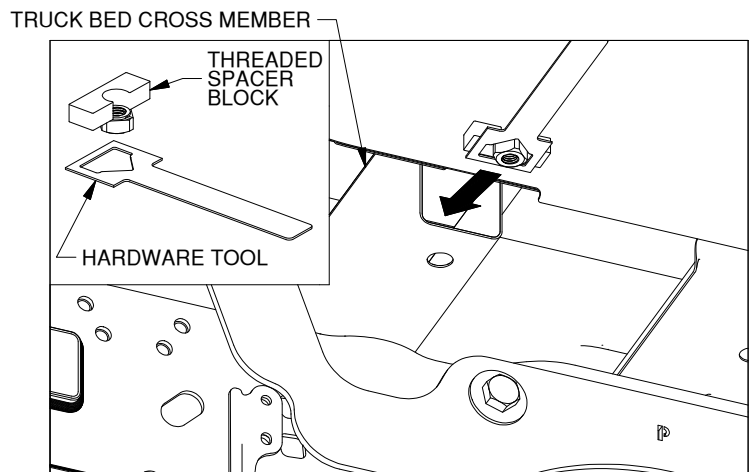

Figure D2: Hardware tool and threaded spacer block. **PAGE 3 of 4**

3. **Install the carriage bolts.** Locate the 1/2" X 4-1/2" carriage bolt, 1/2" X 2" carriage bolts, offset rectangle washers, 1/2" flat washers, 1/2" lock washers and 1/2" finish nuts. Install a 1/2" carriage bolt through the mounting rail in each of the four remaining holes in the rear rail. The 4-1/2" carriage bolt belongs in the forward center hole and should pass through the tube spacer placed under the rail earlier, see Figure D4. Install a u-shaped spacer on the top of the bed under the rail in the two center connections and under the bed above the frame bracket flanges on the two outside connections. Fasten each of the carriage bolts with an offset square washer, 1/2" flat washer, lock washer and nut, see Figure D5. Hand tighten each nut.

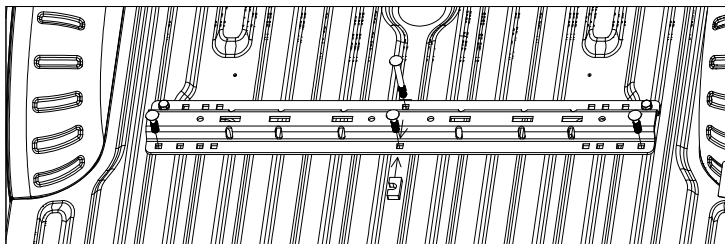

Figure D4: View looking into truck bed from rear of truck.

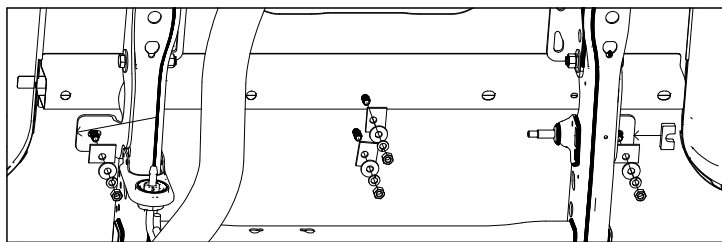

Figure D5: View looking up at underside of bed.

INSTALL FORWARD MOUNTING RAIL

1. **Position the forward mounting rail.** For this step the base which will be used in the mounting rails is required. Place a mounting rail into the truck bed in front of the rear mounting rail. Place the base over the rail attachment points and carefully lower it until the pin tabs pass through the attachment points on the rear mounting rail. Attach the forward mounting rail to the forward mounting points on the base. The base should rest flat against the top of the rails, see Figure E1. With the base still attached ensure that the forward rail is centered in the truck bed.

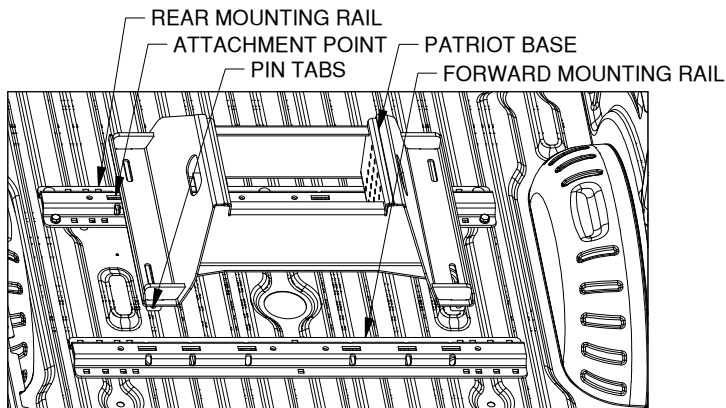

Figure E1: View into truckbed looking towards tailgate.

IMPORTANT: Before drilling forward mounting holes pull the RV base towards the rear of the truck and push the forward rail towards the cab of the truck to correctly space the mounting rails, see Figure E2.

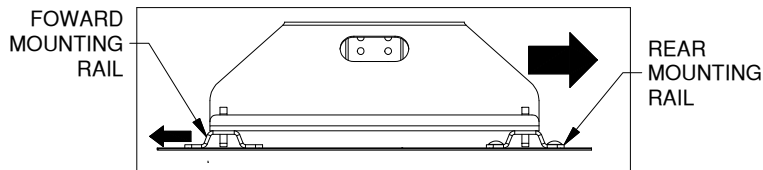

Figure E2: Side view of RV base and mounting rails.

2. **Drill forward mounting holes.** Using the same methods as used for the rear mounting rail mark, drill, check, and enlarge the holes for the forward mounting rail. Refer to "DRILL REAR MOUNTING HOLES" section, steps 2 through 4, on a previous page. Notice that the hole locations are slightly different than the rear rail, see Figure B1 (on the second page).

3. **Install forward mounting rail.** Re-position the forward mounting rail over the drilled 9/16" holes in the bed. Install a 1/2" carriage bolt through the mounting rail into each of the five drilled holes, as shown in Figure E3. Place a u-shaped spacer under the center carriage bolt.

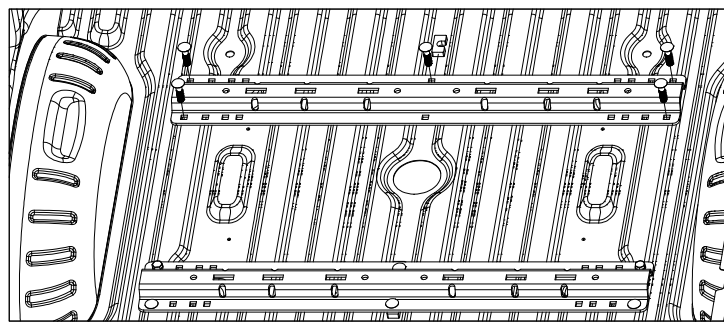

Figure E3: View looking into truck bed from rear of truck.

4. **Install the forward mounting rail, cont.** Under the bed install offset square washers, 1/2" flat washers, 1/2" lock washers, and 1/2" finish nuts on each of the carriage bolts, see Figure E4. Use U-shaped spacers under the four outside mounting locations. Hand tighten each nut.

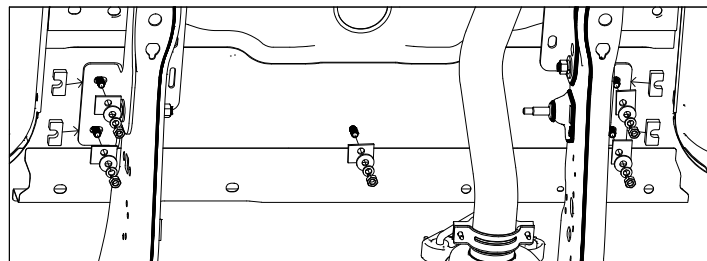

Figure E4: View looking up at underside of bed.

5. **Tighten hardware.** Using a torque wrench, first torque all the 1/2" nuts in the mounting rails to 80 ft-lbs. Second torque all 5/8" nuts in the frame brackets to 150 ft-lbs.