

# Installation Instructions

I - Sheet Number VV08 Rev.A



## Ventvisor® Deflector

**For proper installation and best possible fit, please read all instructions BEFORE you begin.  
For technical assistance or to obtain missing parts, please call Customer Service at 800-241-7219**

### Important Safety Information



- CAUTION - Before driving, ensure that the vent visors are properly secured to vehicle.
- Do not use automatic "brush-style" car washes.
- Do not use cleaning solvents of any kind.
- Periodically check all components for tightness.
- When using Surface Prep, avoid contact with skin. Use in well ventilated area. If contact is made with material, flush area with large amounts of water. If irritation persists, get immediate medical attention. USE PREP ON RUBBER ONLY

### Contents - 2 Piece Set



Front Driver  
Visor



Front Passenger  
Visor

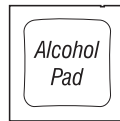

Alcohol Pad x2

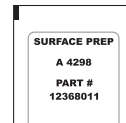

Surface Prep  
Pad

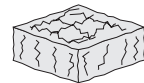

Scotch  
Brite Pad

### Contents - 4 Piece Set

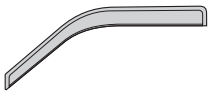

Front Driver  
Visor



Front Passenger  
Visor



Rear Driver's  
Visor



Rear Passenger's  
Visor



Alcohol Pad x4

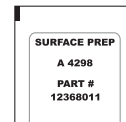

Surface Prep  
Pad

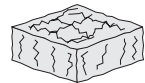

Scotch  
Brite Pad

### Tools Required

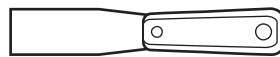

Putty Knife

### Preparation Before Painting / Installation

- Please review your warranty card **BEFORE** installation of this product.
- A trial fit is recommended to ensure proper positioning and fit.
- Check fit of parts before painting as we will not accept the return of modified or painted parts.
- Wash and dry your vehicle to remove any debris and/or dirt from the installation area.

## Front Visor Installation Steps

**NOTE:** Actual application may vary slightly from illustrations.

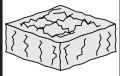

Lower the window & scuff the outside of the window trim where the visor will attach. Clean the scuffed area with an alcohol pad. Apply surface prep scuffed area.

Perform **Step 1** on both front doors, then continue.

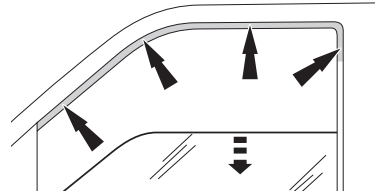

**1**

**CAUTION:** Read surface prep warning on page 1 before continuing.

Remove the tape liner from the rear flange. Peel back 2" (5 cm) of tape liner from each end of top flange.

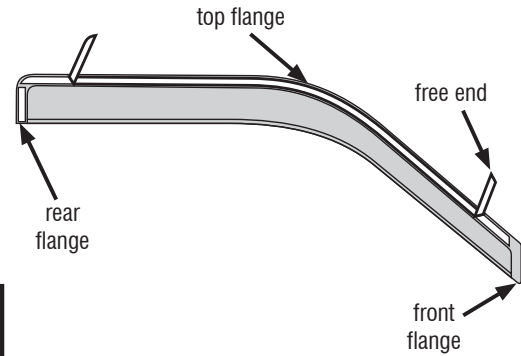

**2**



Slide the front flange behind the mirror cap, use a putty knife to create a gap if needed. Attach the top and rear flanges to the window trim.

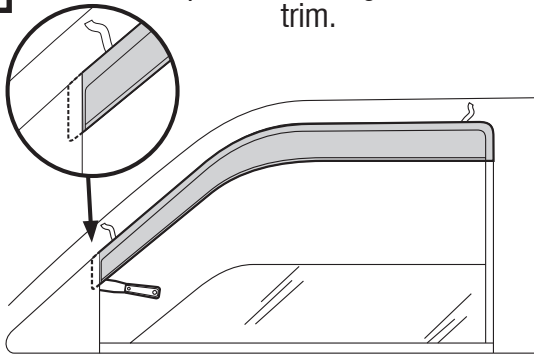

**3**

Remove tape liner by pulling on free ends. Apply pressure to top and rear tape flanges to secure.

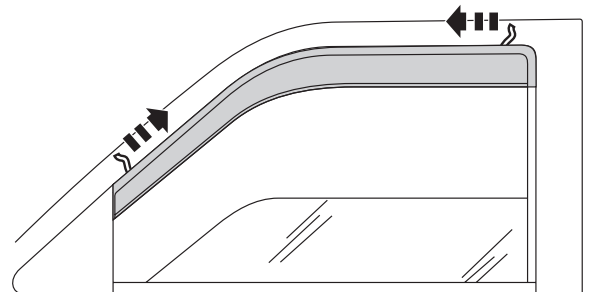

**4**

## 4 Piece Set

**REAR VISORS DO NOT USE SURFACE PREP OR SCOTCH BRITE PAD.**  
Rear visor attaches to the painted surface surrounding the window.

**5**

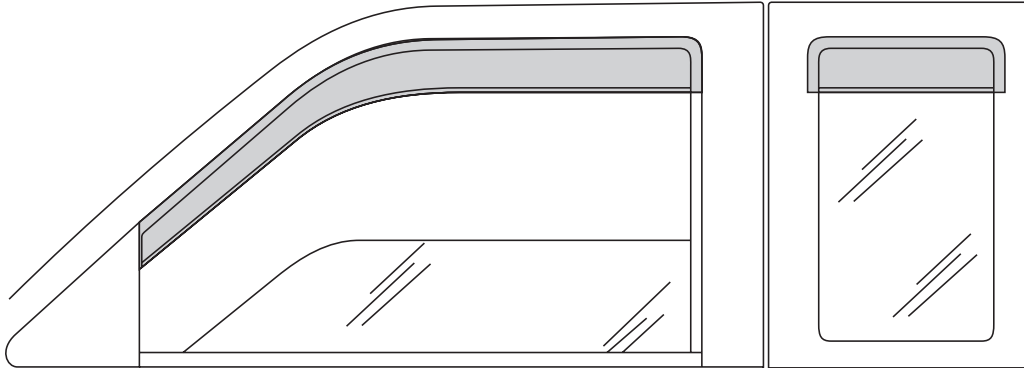

## Care and Cleaning

- Wash only with mild soap & dry with a clean cloth.

## Congratulations!

You have purchased one of the many quality Auto Ventshade™ branded products offered by Lund International, Inc. We take the utmost pride in our products and want you to enjoy years of satisfaction from your investment. We have made every effort to ensure that your product is top quality in terms of fit, durability, finish and ease of installation.



AUTO VENTSHADE™

Lund International, Ventshade Accessories Division

655 Raco Drive, Lawrenceville, GA 30045

800-241-7219 • Fax 770-339-5839 • Visit us at [lundinternational.com](http://lundinternational.com)

© 2005 Lund International, Inc. All rights reserved.

Auto Ventshade™, the Auto Ventshade™ logo and the AVS™ logo are trademarks of Lund International, Inc.





## Défecteur Ventvisor®

Pour obtenir une installation correcte et le meilleur ajustement possible, lire toutes les instructions **AVANT** de commencer. Pour toute assistance technique ou l'obtention de pièces manquantes, contacter le service après-vente au 800-241-7219.

### Informations importantes concernant la sécurité



- ATTENTION – Avant de conduire, s'assurer que la visière est solidement assujettie sur le véhicule.
- Ne pas utiliser les stations de lavage de voitures à brosse.
- Ne pas utiliser de solvants.
- Vérifier régulièrement le serrage des composants.
- En utilisant la préparation extérieure, évitez le contact avec la peau. Employez dans le secteur bien aéré. Si le contact est fait avec le matériel, secteur affleurant avec de grandes quantités de l'eau. Si l'irritation persiste, obtenez une attention médicale immédiate. EMPLOYEZ LA PRÉPARATION SUR LE CAOUTCHOUC SEULEMENT.

### Contenu - Ensemble 2

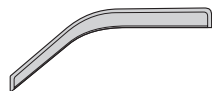

Visière avant côté conducteur

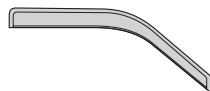

Visière avant côté passager



2 tampons à l'alcool

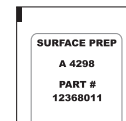

Tampons de préparation de surface



tampon à récurer Scotch Briter

### Contenu - Ensemble 4 pièces



Visière avant côté conducteur

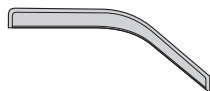

Visière avant côté passager



Visière arrière côté conducteur



Visière arrière côté passager



4 tampons à l'alcool

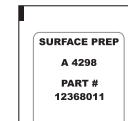

Tampons de préparation de surface

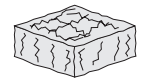

tampon à récurer Scotch Briter

### Outils nécessaires

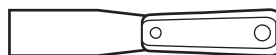

Couteau De Mastic

### Préparation pour la peinture/l'installation

- Consulter la carte de garantie **AVANT** d'installer ce produit.
- Il est recommandé de procéder à un essai pour s'assurer que le positionnement et l'ajustement sont corrects.
- Vérifier l'ajustement des pièces avant peinture, car nous n'acceptons pas le retour de pièces modifiées ou peintes.
- Laver les glissières de glaces de la portière du véhicule pour éliminer toute poussière et tous débris.
- Sécher les glissières avec une serviette propre.

## Étapes d'installation

REMARQUE : La méthode d'application peut être légèrement différente de celle représentée par les illustrations.

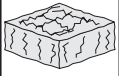

Abaisser la glace et abraser l'endroit où la visière doit être fixée. Nettoyer l'endroit abrassé avec un tampon à l'alcool. Appliquer l'apprêt sur l'endroit abrassé.

Exécuter l'étape 1 sur les deux portières avant, puis continueur.

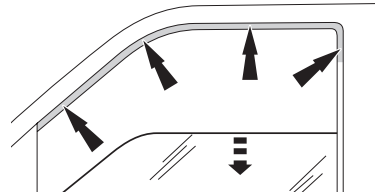

1

**ATTENTION : Lire l'avertissement concernant l'apprêt, page 1, avant de continuer.**

Retirer la protection d'adhésif de la patte arrière. Découler environ 5 cm (2 po) de protection d'adhésif à chaque extrémité du rebord supérieur.

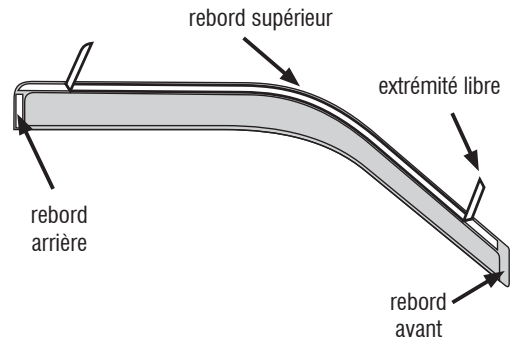

2



Glisser le rebord avant derrière le couvercle de rétroviseur. Au besoin, utiliser une couteau à mastiquer pour permettre le passage du rebord. Installer les visières avant et arrière sur l'encadrement de glace.

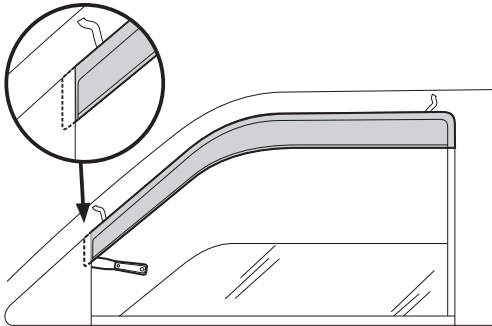

3

Retirer la protection d'adhésif en tirant sur les extrémités libres. Appuyer sur le haut et l'arrière pour faire adhérer le ruban.

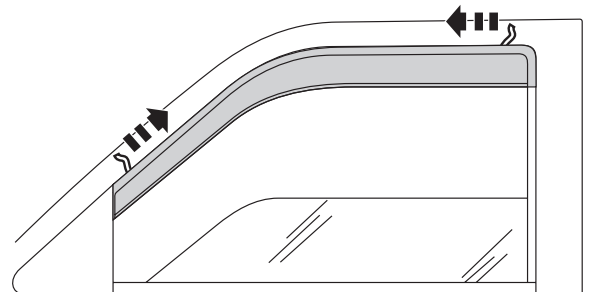

4

## Ensemble 4 pièces

**IL N'EST PAS NÉCESSAIRE D'UTILISER L'APPRÊT OU LE TAMPON SCOTCH BRITE POUR LES VISIÈRES ACCRIÈRE**

Les visières arrière se montent sur la surface peinte encadrant la glace.

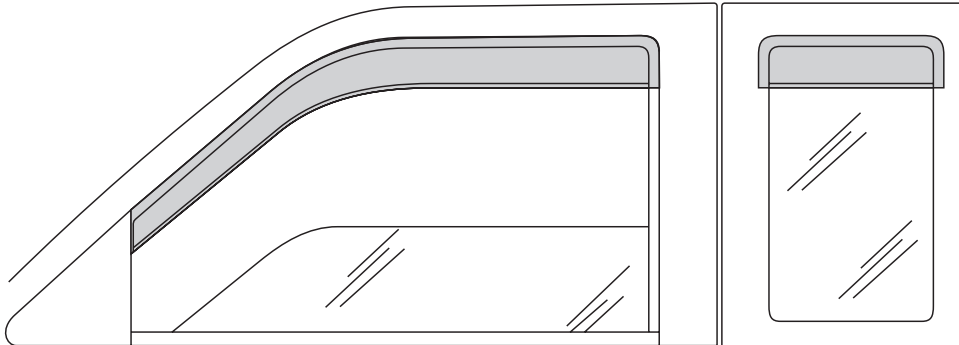

5

## Entretien et nettoyage

- Laver exclusivement avec de l'eau savonneuse et sécher avec un chiffon propre.

## Félicitations !

Vous avez acheté l'un des nombreux produits de qualité Auto Ventshade™ fabriqués par Lund International, Inc. Nous sommes extrêmement fiers de nos produits et souhaitons que vous tiriez des années de satisfaction de votre investissement. Nous avons pris toutes les mesures nécessaires pour assurer que ce produit est d'une qualité supérieure en ce qui concerne l'ajustement, la durabilité, la finition et la facilité d'installation.



Lund International, Ventshade Accessories Division  
655 Raco Drive, Lawrenceville, GA 30045, USA

800-241-7219 • Fax 770-339-5839 • Visitez notre site [lundinternational.com](http://lundinternational.com)

© 2005 Lund International, Inc. Tous droits réservés.

Auto Ventshade™, le logo Auto Ventshade™ et le logo AVS™ sont des marques déposées de Lund International, Inc.





## Deflector Ventvisor®

**Para una instalación adecuada y el mejor ajuste posible, lea todas las instrucciones ANTES de comenzar. Si desea recibir asistencia técnica o bien obtener piezas faltantes, llame al Servicio al cliente al 800-241-7219**

### Información importante de seguridad



- **PRECAUCIÓN** - Antes de conducir, asegúrese de que la visera deflectora esté correctamente anclada al vehículo.
- No utilice servicios automáticos de limpieza de vehículos que utilizan cepillos.
- No utilice limpiadores al solvente de ningún tipo.
- Compruebe periódicamente que todos los componentes estén ajustados.
- Al usar la preparación superficial, evite el contacto con la piel. Utilice en área bien ventilada. Si el contacto se hace con el material, área rasante con cantidades grandes de agua. Si persiste la irritación, consiga la atención médica inmediata. **UTILICE LA PREPARACIÓN EN EL CAUCHO SOLAMENTE**

### Contenido - Juego de dos piezas

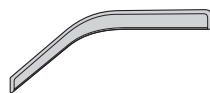

Visera delantera del conductor

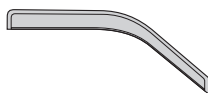

Visera delantera del acompañante



Paños esterilizados (2)

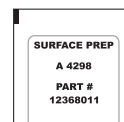

Paño prep. de superficies

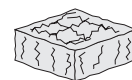

el paño Scotch Brite

### Contenido - Juego de cuatro piezas



Visera delantera del conductor



Visera delantera del acompañante

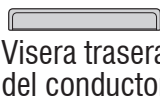

Visera trasera del conductor

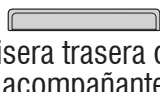

Visera trasera del acompañante



Paños esterilizados (4)

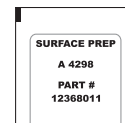

Paño preparador de superficies

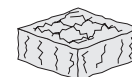

el paño Scotch Brite

### Herramientas necesarias

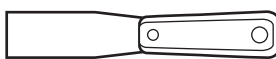

Cuchillo De la Masilla

### Preparación antes de pintar o instalar

- Consulte su tarjeta de garantía **ANTES** de instalar este producto.
- Se recomienda realizar un ajuste de prueba para asegurar el posicionamiento y ajuste correctos.
- Compruebe que las piezas se ajusten correctamente antes de pintarlas, ya que no aceptaremos la devolución de piezas modificadas o pintadas.
- Lave los canales de la ventanilla del vehículo para quitar los desechos y la suciedad.
- Seque los canales de la ventanilla con una toalla limpia.

## Pasos de instalación

**NOTA:** El uso real puede variar levemente de ilustraciones.

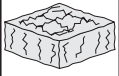

Baje la ventanilla y restriegue el exterior de la banda lateral de la ventanilla en donde colocará la visera. Limpie el área restregada con un paño esterilizado. Aplique el preparador de superficie en el área restregada.

Realice el **paso 1** en ambas puertas delanteras, luego continúe.

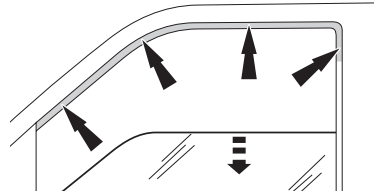

1

**PRECAUCIÓN:** Lea la advertencia del preparador de superficie en la página 1 antes de continuar.

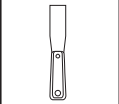

Deslice el reborde frontal por detrás de la cubierta del espejo. Si es necesario, utilice una espátula para crear el espacio. Coloque el reborde superior y trasero en la banda lateral de la ventanilla.

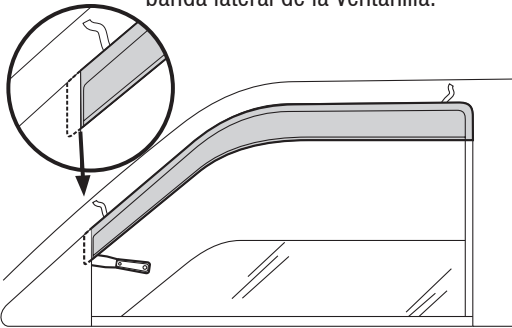

3

Quite la cinta protectora del reborde trasero. Retire 2 pulgs. de cinta protectora de cada uno de los extremos del reborde superior.

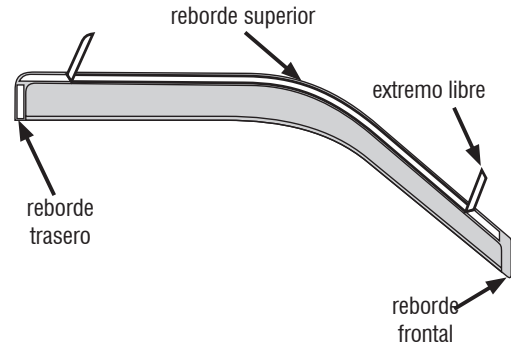

2

Retire la cinta protectora tirando de los extremos libres. Aplique presión sobre los rebordes de cinta superior y trasero para ajustar.

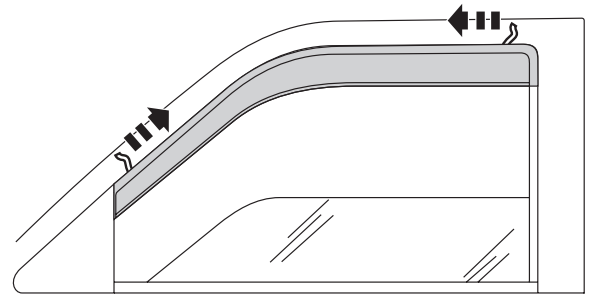

4

## Juego de cuatro piezas

**LAS VISERAS TRASERAS NO NECESITAN PREPARADOR DE SUPERFICIE NI PAÑO SCOTCH BRITE.**

La visera trasera se coloca en la superficie pintada que rodea la ventanilla.

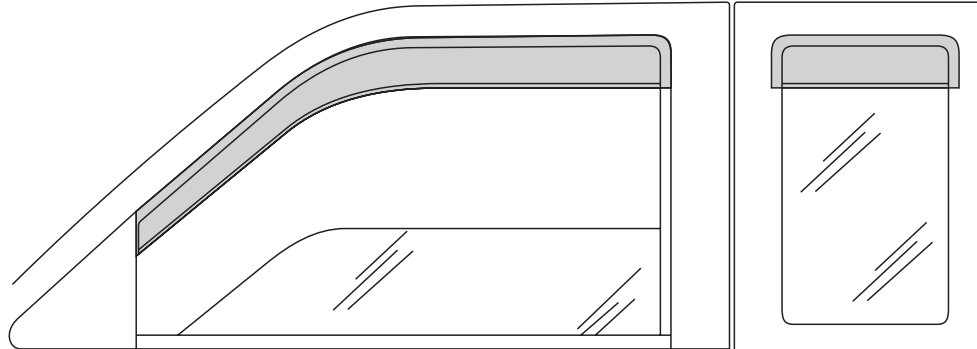

5

## Cuidado y limpieza

- Limpie solamente con agua jabonosa tibia y seque con un paño limpio.

## Felicidades

Usted ha comprado uno de los tantos artículos de calidad de Auto Ventshade™ ofrecidos por Lund International, Inc. Nuestros productos son nuestro mayor orgullo. Deseamos que disfrute de años de satisfacción con su inversión. Hemos realizado todos los esfuerzos para asegurarnos de que su producto sea de la mejor calidad en cuanto a ajuste, durabilidad, acabado y facilidad de instalación.



Lund International, Ventshade Accessories Division  
655 Raco Drive, Lawrenceville, GA 30045

800-241-7219 • Fax 770-339-5839 • Visite nuestro sitio Web: [lundinternational.com](http://lundinternational.com)

© 2005 Lund International, Inc. Todos los derechos reservados.



Auto Ventshade™, el logo de Auto Ventshade™ y el logo de AVS™ son marcas comerciales de Lund International, Inc.

