

# Installation Instructions

I - Sheet Number VV59 Rev.A



AUTO VENT SHADE™

## Ventvisor® Deflector

For proper installation and best possible fit, please read all instructions **BEFORE** you begin.  
For technical assistance or to obtain missing parts, please call Customer Relations at 1-800-241-7219.

### Important Safety Information



- CAUTION - Before driving, ensure that the vent visor is properly secured to vehicle.
- Do not use automatic "brush-style" car washes.
- Do not use cleaning solvents of any kind.
- Periodically check all components for tightness.

### Contents - 2 Piece Set **NOTE:** Actual product may vary from illustration.



Front Driver Side Visor



Front Passenger Side Visor



Alcohol Pads x2



GP3 Clip x4



Scotch brite pad

### Contents - 4 Piece Set



Front Driver Side Visor



Front Passenger Side Visor



Rear Driver Side Visor



Rear Passenger Side Visor



Alcohol Pads x4



GP3 Clip x8

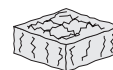

Scotch brite pad

### Tools Required



Car Wash Supplies



Clean Towel



Flathead Screwdriver

### Preparation Before Painting / Installation

- A trial fit is recommended to ensure proper positioning and fit.
- Check fit of parts before painting as we will not accept the return of modified or painted parts.
- Wash and dry your vehicle to remove any debris and/or dirt from the installation area.

### Installation Steps **NOTE:** Actual application may vary slightly from illustrations.

Lower front drivers side window.

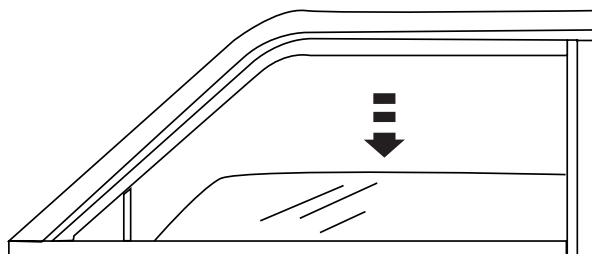

1

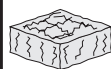

Buff **INSIDE** the rubber window channel with Scotch brite scuff pad, and wipe clean with an alcohol pad and dry with a clean cloth.

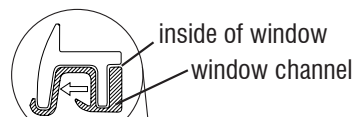

2

# Installation Steps

**NOTE:** Actual application may vary slightly from illustrations.

Remove the tape liner from the front and rear flanges of visor. Peel back 2" (5 cm) of tape liner from each end of the lateral flange.

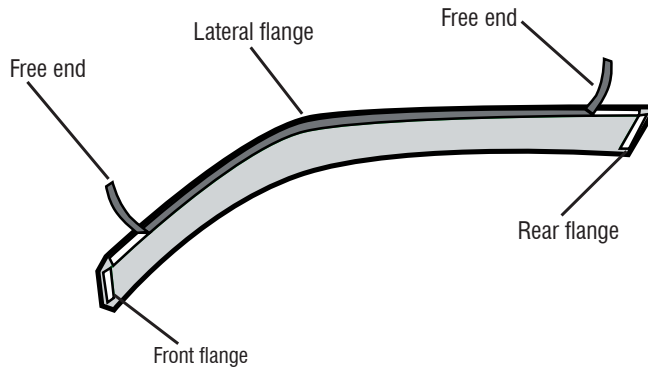

3

Insert the rear end flange of the visor into the rubber window channel first. Then flex the visor slightly and rotate the visor into position inside the rubber window channel.

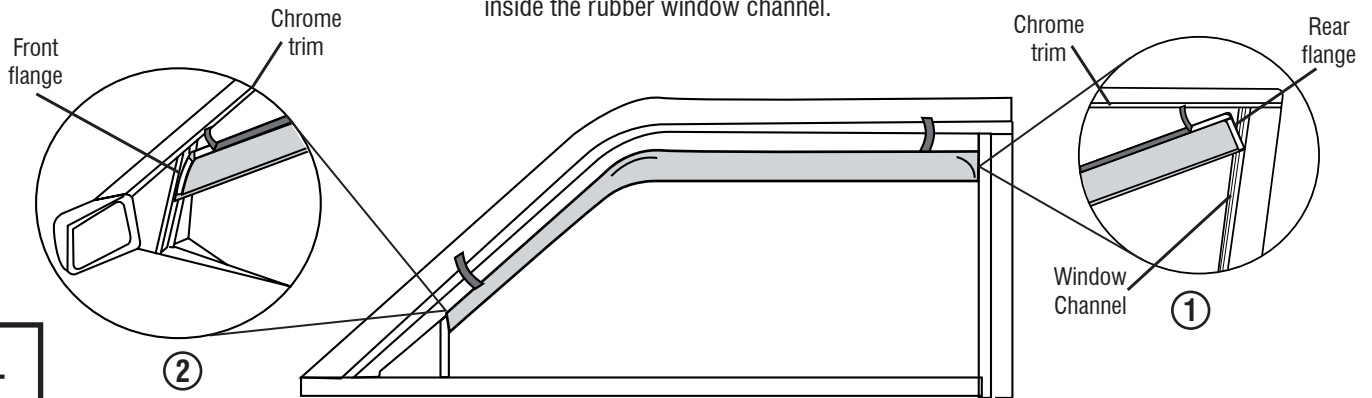

4

Remove remaining tape liner by pulling on free ends.

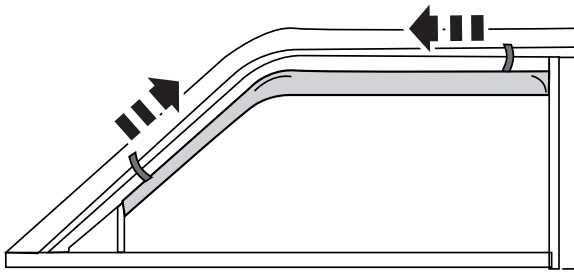

5

Apply pressure along the inside rubber window channel to press tape against the inside of the window channel.

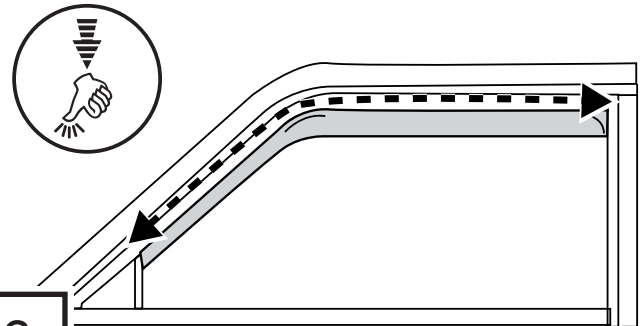

6

Place a black GP-3 clip inside the window channel at the front and rear end flanges. Use a flat blade screwdriver to press the clip into place. Be sure the rubber window channel overlaps the inner leg of the clip.

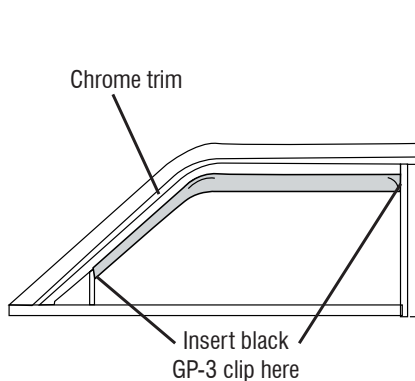
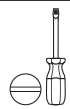

7

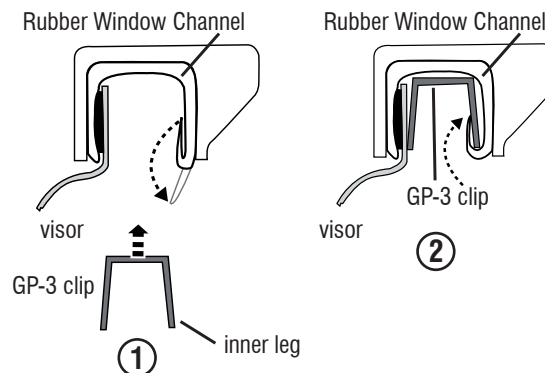

(1) Pull inner rubber window channel flap down, then insert GP-3 clip and snap it into place with a screwdriver.  
(2) Then release the inner rubber window channel flap so that it overlaps the GP-3 clip.

## Installation Steps

**NOTE:** Actual application may vary slightly from illustrations.

Roll window up and leave closed for 24 hours to ensure tape adhesion.

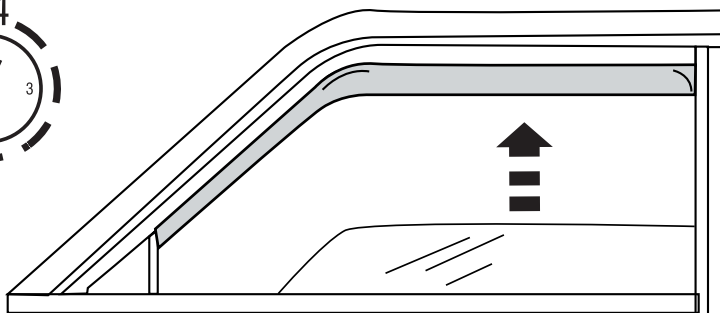

8

Repeat **Steps 1-8** for opposite side.

## 4 Piece Set

The rear visor attaches with the same preparation methods as the front, except that the **FRONT** end flange is inserted into the rubber window channel first. Figure 9 shows the rear visor in its final position.

Repeat for opposite side.

Insert black GP-3 clip here

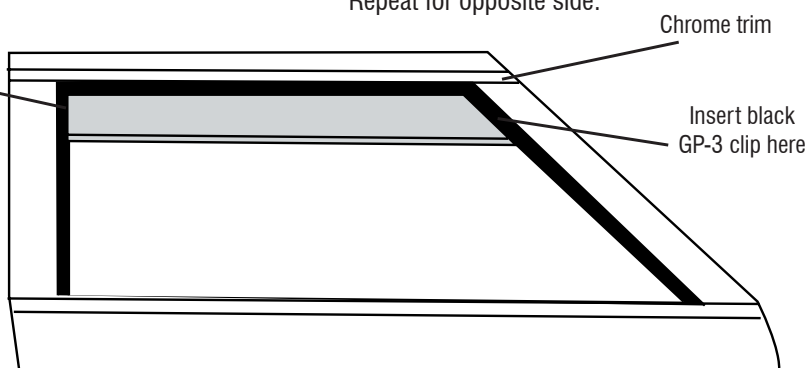

9

## Care and Cleaning

- Wash only with mild soap & dry with a clean cloth.

## Congratulations!

You have purchased one of the many quality Auto Ventshade™ branded products offered by Lund International, Inc. We take the utmost pride in our products and want you to enjoy years of satisfaction from your investment. We have made every effort to ensure that your product is top quality in terms of fit, durability, finish and ease of installation.



**AUTO VENTSHADE™**

Lund International, Ventshade Accessories Division

655 Raco Drive, Lawrenceville, GA 30045

800-241-7219 • Fax 770-339-5839 • Visit us at [lundinternational.com](http://lundinternational.com)



© 2005 Lund International, Inc. All rights reserved.  
Auto Ventshade™, the Auto Ventshade™ logo and the AVS™ logo are trademarks of Lund International, Inc.





## Ventvisor® Deflector

Pour obtenir une installation correcte et le meilleur ajustement possible, lire toutes les instructions **AVANT** de commencer.  
 Pour toute assistance technique ou obtention de pièces manquantes, appeler le service des relations avec la clientèle au  
**1-800-241-7219.**

### Informations importantes concernant la sécurité



- **ATTENTION** – Avant de conduire, s'assurer que la visière est solidement assujettie sur le véhicule.
- Ne pas utiliser les stations de lavage de voitures à brosses.
- Ne pas utiliser de solvants.
- Vérifier régulièrement le serrage des composants.

### Contenu - Ensemble 2 pièces

**NOTE:** Le produit réel peut changer de l'illustration.

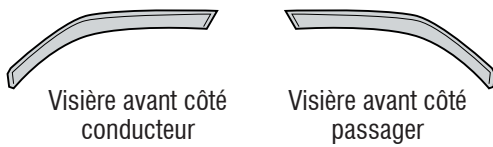

(2) tampons à l'alcool



(4) agrafe GP3

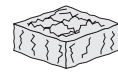

tampon à récurer Scotch Brite

### Contenu - Ensemble 4 pièces

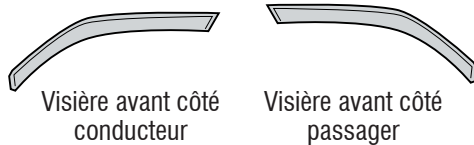

(4) tampons à l'alcool



(8) agrafe GP3



tampon à récurer Scotch Brite

### Outils nécessaires



Fournitures pour lavage de voiture



Serviette propre



Tournevis À tête plate

### Préparation pour la peinture/l'installation

- Il est recommandé de procéder à un essai pour s'assurer que le positionnement et l'ajustement sont corrects.
- Vérifier l'ajustement des pièces avant peinture, car nous n'acceptons pas le retour de pièces modifiées ou peintes.
- Laver les glissières de glaces de la portière du véhicule pour éliminer toute poussière et tous débris.
- Sécher les glissières avec une serviette propre.

### Étapes d'installation

**REMARQUE :** La méthode d'application peut être légèrement différente de celle représentée par les illustrations.

Abaisser la glace avant côté conducteur.

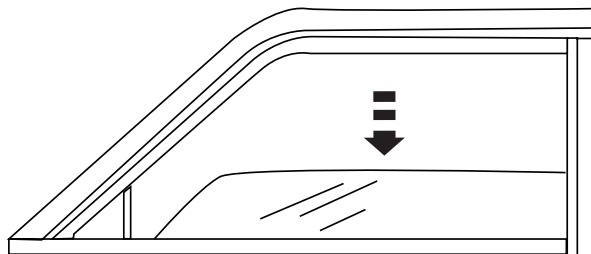

1



Frotter la glissière en caoutchouc **INTÉRIEURE** de la glace avec un tampon à récurer Scotch Brite, la nettoyer avec un tampon à l'alcool et la sécher avec un chiffon propre.

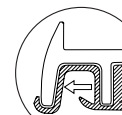

Intérieur de la glace  
 Glissière de la glace

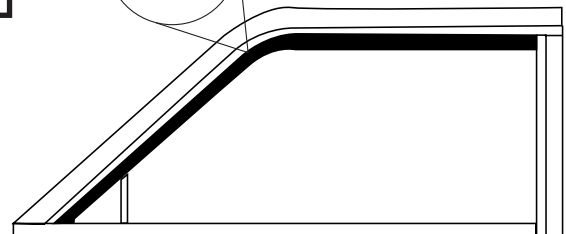

2

# Étapes d'installation

REMARQUE : La méthode d'application peut être légèrement différente de celle représentée par les illustrations.

Retirer la protection d'adhésif des rebords avant et arrière de la visière. Décoller 5 cm (2 po) de protection d'adhésif à chaque extrémité du rebord latéral.

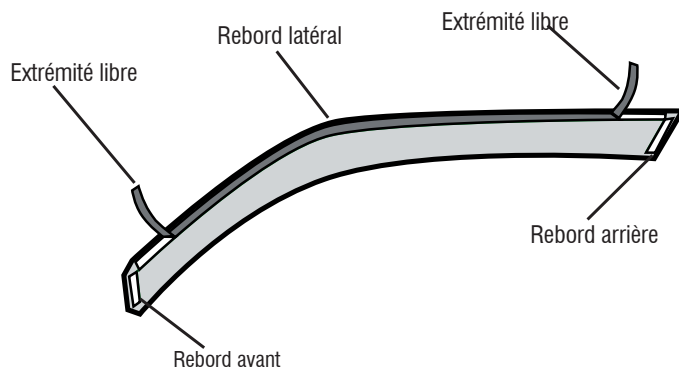

3

Insérer le rebord d'extrémité arrière de la visière dans la glissière en caoutchouc de la glace en premier. Faire ensuite légèrement fléchir la visière puis la tourner pour la mettre en position à l'intérieur de la glissière en caoutchouc de la glace.

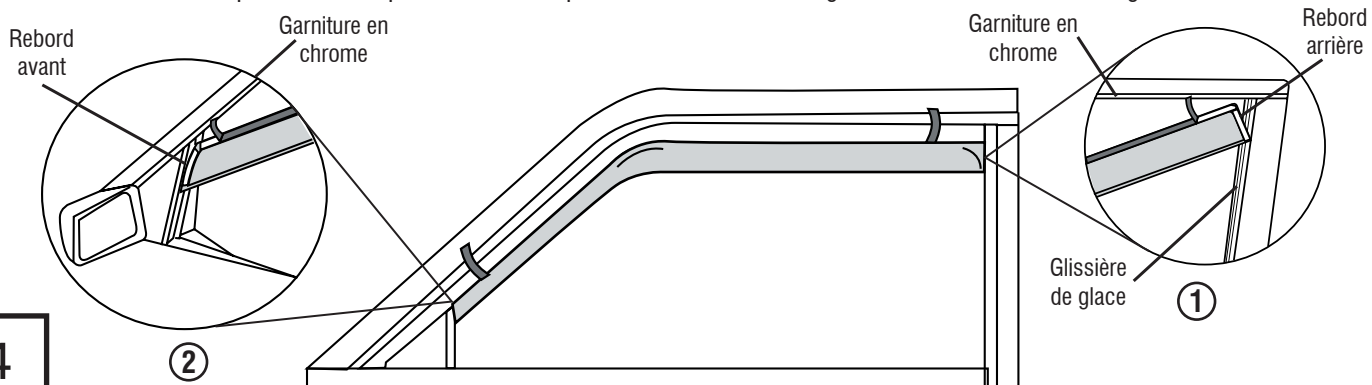

4

Retirer la protection d'adhésif restante en tirant sur ses extrémités libres.

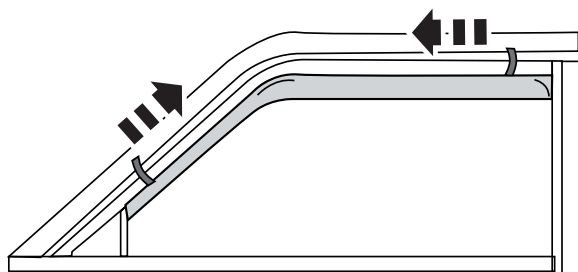

5

Appuyer tout le long de la glissière en caoutchouc de la glace pour bien faire adhérer le ruban adhésif à l'intérieur de la glissière.

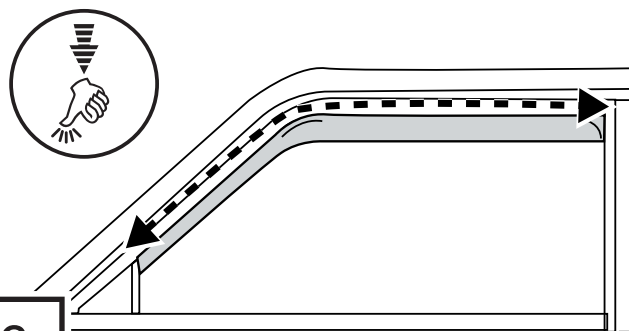

6

Placer un clip GP-3 noir à l'intérieur de la glissière de glace, au niveau des rebords d'extrémité avant et arrière. Enfoncer le clip en place à l'aide d'un tournevis à lame plate. S'assurer que la glissière en caoutchouc de la glace enchevauche la patte intérieure du clip.

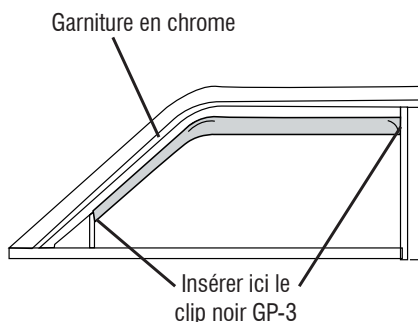
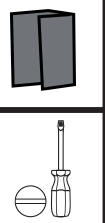

7

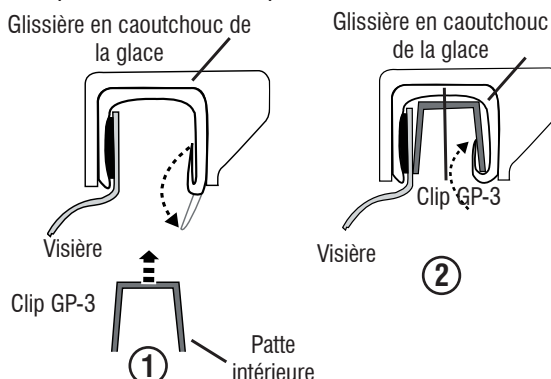

(1) Tirer vers le bas la partie rabattue intérieure de la glissière en caoutchouc de la glace, insérer le clip GP-3 puis l'enclencher en place à l'aide d'un tournevis.  
 (2) Relâcher ensuite la partie rabattue intérieure de la glissière en caoutchouc de la glace de façon à ce qu'elle enchevauche le clip GP-3.

## Étapes d'installation

**REMARQUE :** La méthode d'application peut être légèrement différente de celle représentée par les illustrations.

Relever la glace et la laisser fermée pendant 24 heures pour assurer la bonne adhésion du ruban.

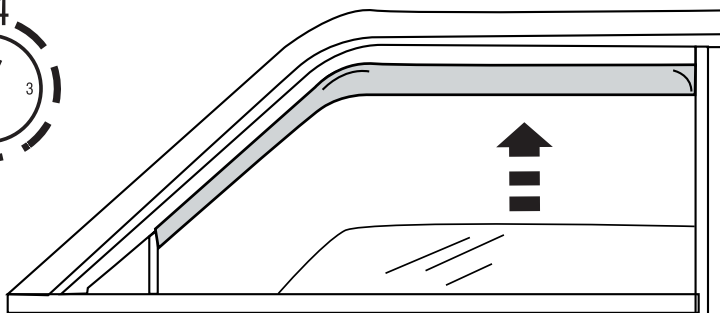

8

Répéter les étapes 1 à 8 pour le côté opposé.

## Ensemble 4 pièces

La méthode de préparation pour la fixation de la visière arrière est la même que celle du devant, excepté le fait que c'est le rebord d'extrémité AVANT qui est inséré en premier dans la glissière en caoutchouc de la glace. La figure 9 illustre la visière arrière en position finale.

Répéter la procédure du côté opposé.

Insérer ici le clip noir GP-3

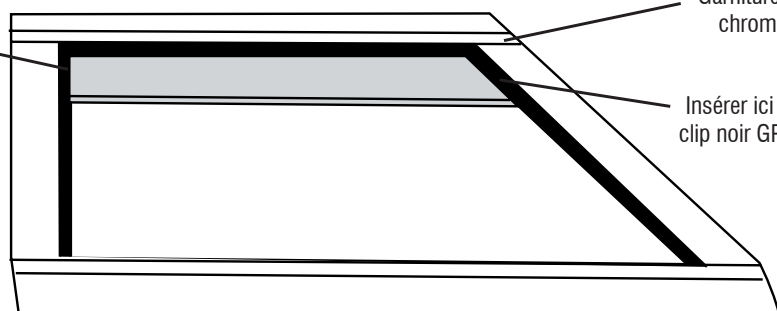

9

## Entretien et nettoyage

- Laver exclusivement avec de l'eau savonneuse et sécher avec un chiffon propre.

## Félicitations !

Vous avez acheté l'un des nombreux produits de qualité Auto Ventshade™ fabriqués par Lund International, Inc. Nous sommes extrêmement fiers de nos produits et souhaitons que vous tiriez des années de satisfaction de votre investissement. Nous avons pris toutes les mesures nécessaires pour assurer que ce produit est d'une qualité supérieure en ce qui concerne l'ajustement, la durabilité, la finition et la facilité d'installation.



AUTO VENTSHADE™

Lund International, Ventshade Accessories Division

655 Raco Drive, Lawrenceville, GA 30045, USA

800-241-7219 • Fax 770-339-5839 • Visitez notre site [lundinternational.com](http://lundinternational.com)



© 2005 Lund International, Inc. Tous droits réservés.  
Auto Ventshade™, le logo Auto Ventshade™ et le logo AVS™ sont des marques déposées de Lund International, Inc.





## Ventvisor® Deflector

Para una instalación adecuada y el mejor ajuste posible, lea todas las instrucciones ANTES de comenzar. Si desea recibir asistencia técnica u obtener piezas faltantes, llame al Servicio al cliente al 1-800-241-7219.

### Información importante de seguridad



- PRECAUCIÓN - Antes de conducir, asegúrese de que la visera esté correctamente anclada al vehículo.
- No utilice servicios automáticos de limpieza de vehículos que utilizan cepillos.
- No utilice limpiadores al solvente de ningún tipo.
- Compruebe periódicamente que todos los componentes estén ajustados.

### Contenido - Juego de dos piezas

NOTA: El producto real puede variar de la ilustración.

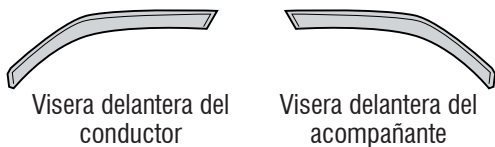

Paños esterilizados (2)



GP3 Clip (4)

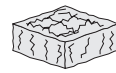

el paño Scotch Brite

### Contenido - Juego de cuatro piezas

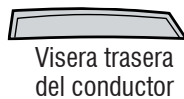
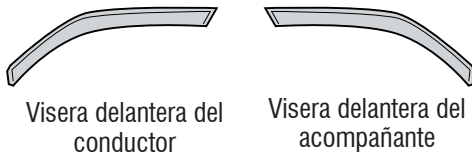

Visera trasera del conductor



Visera trasera del acompañante



Paños esterilizados (4)



GP3 Clip (8)

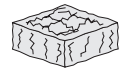

el paño Scotch Brite

### Herramientas necesarias



Equipo de limpieza de vehículos



Toalla limpia



Destornillador De cabeza llana

### Preparación antes de pintar o instalar

- Se recomienda realizar un ajuste de prueba para asegurar el posicionamiento y ajuste correctos.
- Compruebe que las piezas se ajusten correctamente antes de pintarlas, ya que no aceptaremos la devolución de piezas modificadas o pintadas.
- Lave los canales de la ventanilla del vehículo para quitar los desechos y la suciedad.
- Seque los canales de la ventanilla con una toalla limpia.

### Pasos de instalación

AVISO: La colocación real puede variar con respecto a las ilustraciones.

Baje la ventanilla delantera del conductor.

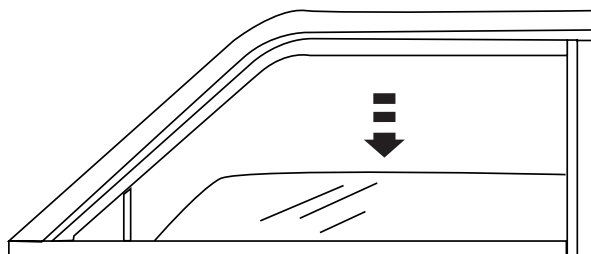

1



Pula el **INTERIOR** del canal de goma de la ventanilla con un paño para restregar Scotch Brite, límpielo con un paño esterilizado y séquelo con otro seco.

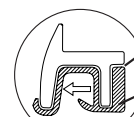

interior de la ventanilla  
canal de la ventanilla

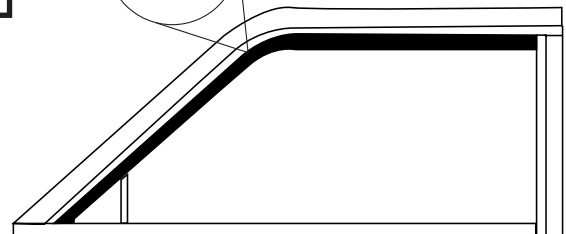

2

## Pasos de instalación

**AVISO:** La colocación real puede variar con respecto a las ilustraciones.

Quite la cinta protectora de los rebordes frontal y trasero de la visera. Retire 2" (5 cm) de cinta protectora de cada uno de los extremos del reborde lateral.

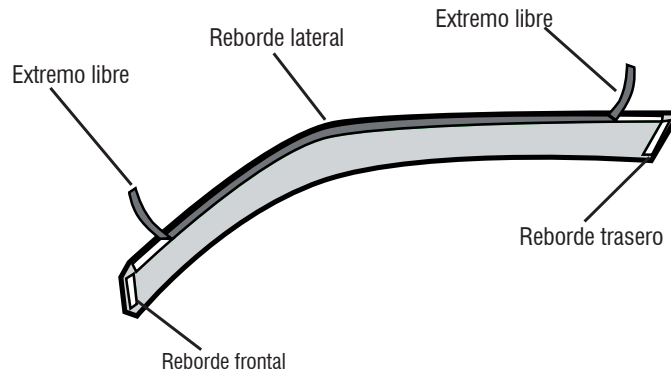

3

Primero, inserte el reborde del extremo trasero de la visera dentro del canal de goma de la ventanilla. Luego doble levemente la visera y gírela hasta colocarla dentro del canal de goma de la ventanilla.

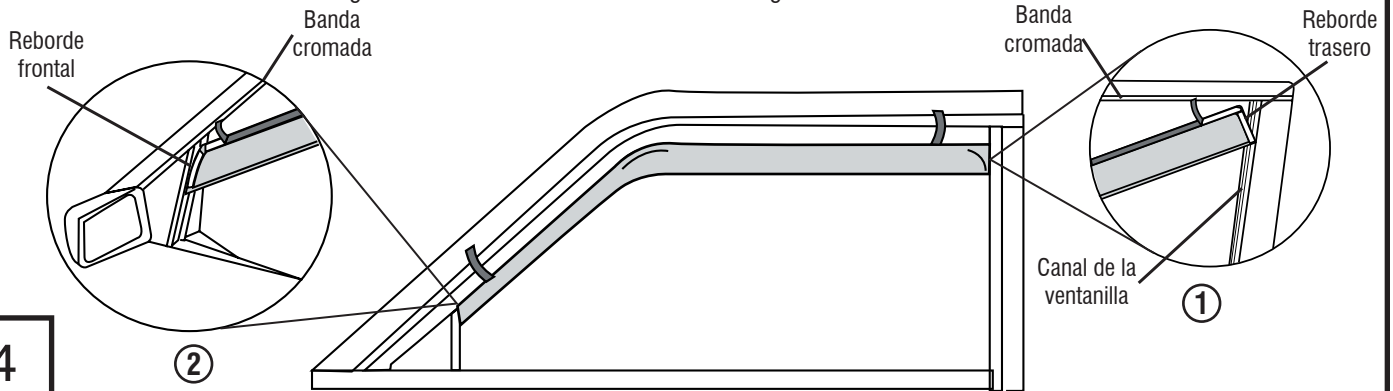

4

Quite la cinta protectora restante tirando de los extremos libres.

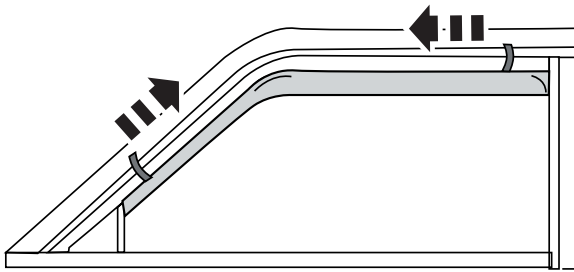

5

Presione a lo largo del canal de goma interior de la ventanilla para empujar la cinta contra el interior del canal de la ventanilla.

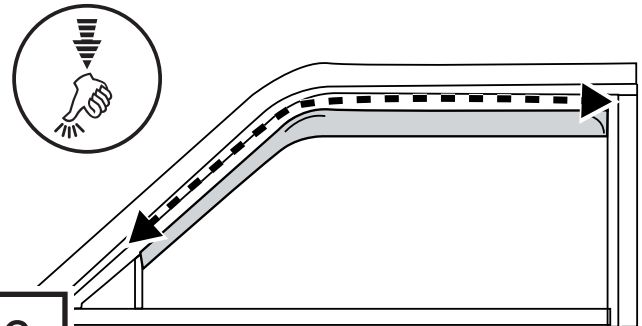

6

Coloque una presilla GP-3 negra dentro del canal de la ventanilla en los rebordes delantero y trasero. Con un destornillador plano presione la presilla para fijarla en su lugar. Asegúrese de que el canal de goma de la ventanilla se superponga con la pata interna de la presilla.

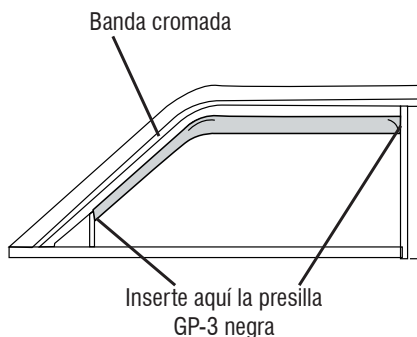
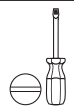

7

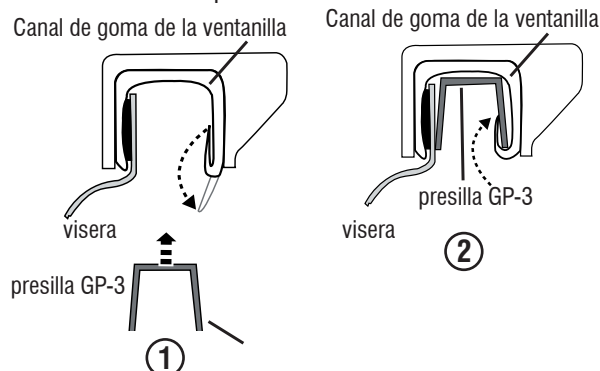

(1) Tire hacia abajo la aleta del canal de goma interior de la ventanilla, luego inserte la presilla GP-3 y encájela en su lugar con un destornillador.  
(2) Luego suelte la aleta del canal de goma interior de la ventanilla para que se superponga con la presilla GP-3.



## Pasos de instalación

**AVISO:** La colocación real puede variar con respecto a las ilustraciones.

Roll window up and leave closed for 24 hours to ensure tape adhesion.

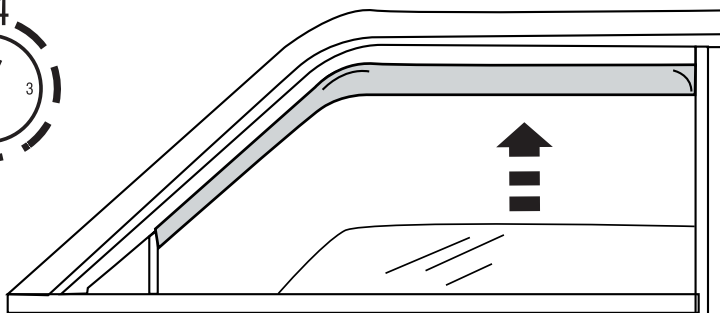

8

Repeat **Steps 1-8** for opposite side.

## 4 Piece Set

The rear visor attaches with the same preparation methods as the front, except that the **FRONT** end flange is inserted into the rubber window channel first. Figure 9 shows the rear visor in its final position.

Repeat for opposite side.

Insert black GP-3 clip here

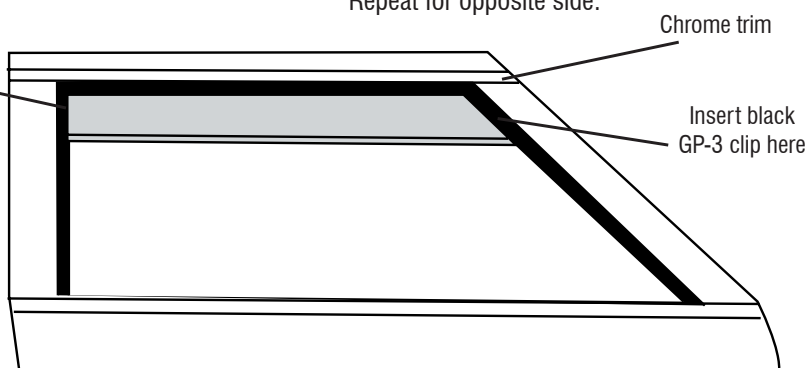

9

## Cuidado y limpieza

- Limpie solamente con agua jabonosa tibia y seque con un paño limpio.

## Felicidades

Usted ha comprado uno de los tantos artículos de calidad de Auto Ventshade™ ofrecidos por Lund International, Inc. Nuestros productos son nuestro mayor orgullo. Deseamos que disfrute de años de satisfacción con su inversión. Hemos realizado todos los esfuerzos para asegurarnos de que su producto sea de la mejor calidad en cuanto a ajuste, durabilidad, acabado y facilidad de instalación.



AUTO VENTSHADE™

Lund International, Ventshade Accessories Division

655 Raco Drive, Lawrenceville, GA 30045

800-241-7219 • Fax 770-339-5839 • Visite nuestro sitio Web: [lundinternational.com](http://lundinternational.com)



© 2005 Lund International, Inc. Todos los derechos reservados.  
™ Auto Ventshade™, el logo de Auto Ventshade™ y el logo de AVS™ son marcas comerciales de Lund International, Inc.

