

Installation Instructions

I - Sheet Number VV74 Rev.A



Ventvisor® Deflector

**For proper installation and best possible fit, please read all instructions BEFORE you begin.
For technical assistance or to obtain missing parts, please call Customer Relations at 1-800-241-7219.**

Important Safety Information



- CAUTION - Before driving, ensure that the vent visor is properly secured to vehicle.
- Do not use automatic "brush-style" car washes.
- Do not use cleaning solvents of any kind.
- Periodically check all components for tightness.

Contents - 2 Piece Set **NOTE:** Actual product may vary from illustration.

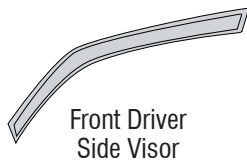

Front Driver Side Visor

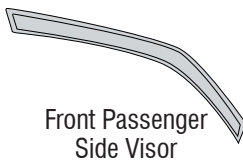

Front Passenger Side Visor



Alcohol Pad x2

Contents - 4 Piece Set

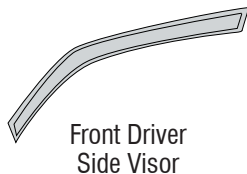

Front Driver Side Visor

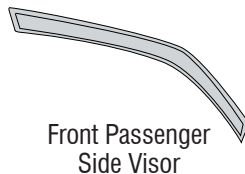

Front Passenger Side Visor



Rear Driver Side Visor

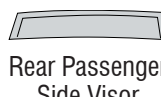

Rear Passenger Side Visor



Alcohol Pad x4

Tools Required



Car Wash Supplies



Clean Towel

Preparation Before Painting / Installation

- A trial fit is recommended to ensure proper positioning and fit.
- Check fit of parts before painting as we will not accept the return of modified or painted parts.
- Wash and dry your vehicle to remove any debris and/or dirt from the installation area.

Installation Steps **NOTE:** Actual application may vary slightly from illustrations.

Completely lower drivers side window.

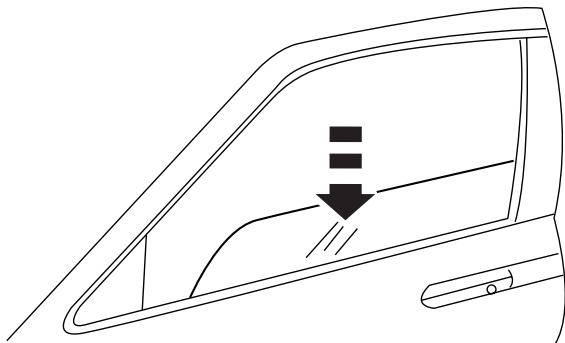

1

Pull out the rubber window channel to the extent shown.

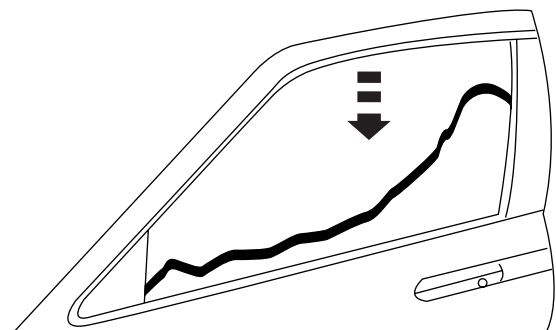

2

Installation Steps

NOTE: Actual application may vary slightly from illustrations.



Clean the **inside** of the metal frame with an alcohol pad and dry with a soft cloth.

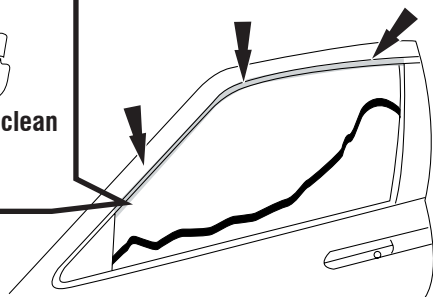
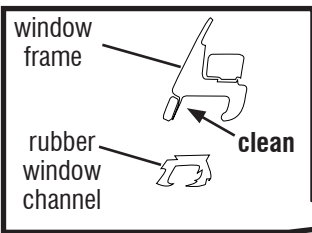

3

Remove tape liner from front and rear flange. Peel back 2" (5 cm) of tape liner from each end of lateral flange.

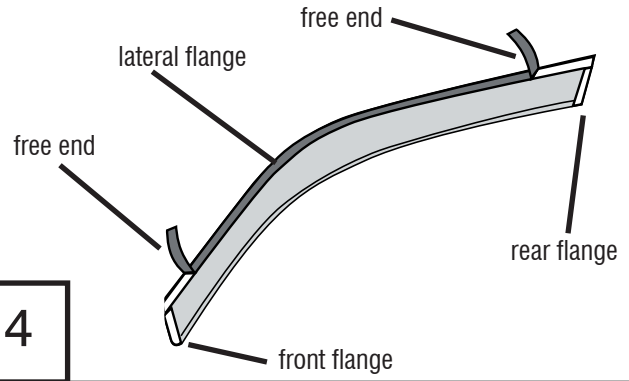

4

Place the deflector in the window frame, beginning at the front, flexing it slightly to insert the rear end flange. Ensure free ends of tape liner are accessible.

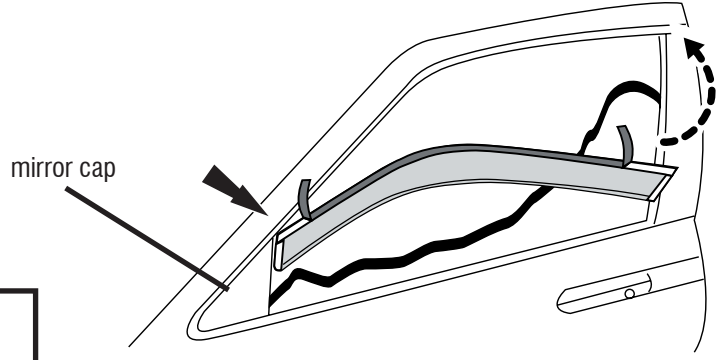

5

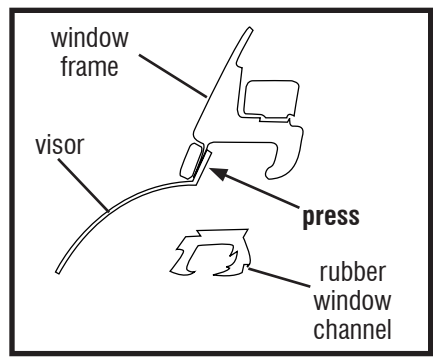

cross section of visor in place

With the visor in its final position, remove the remaining tape liner by pulling on free ends.

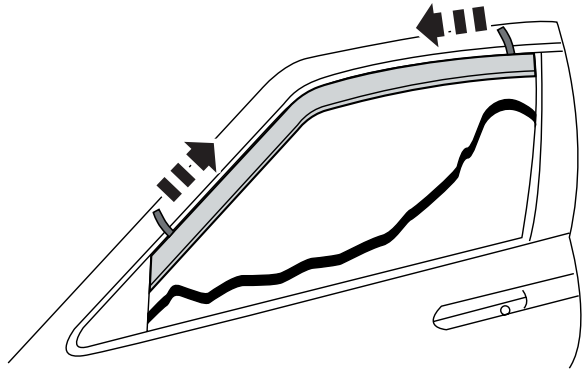

6

To ensure good adhesion of tape apply pressure along the backside of the visor flanges.

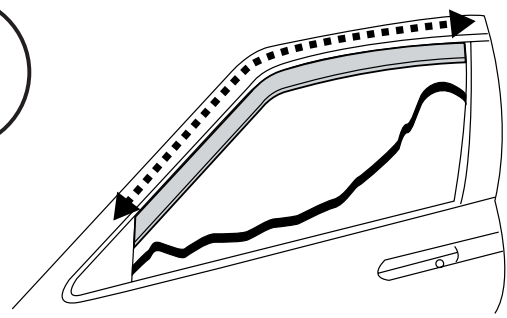

7

Reseat the rubber window channel, beginning at top rear corner. The top rear corner must be reseated properly before installing remaining channel.

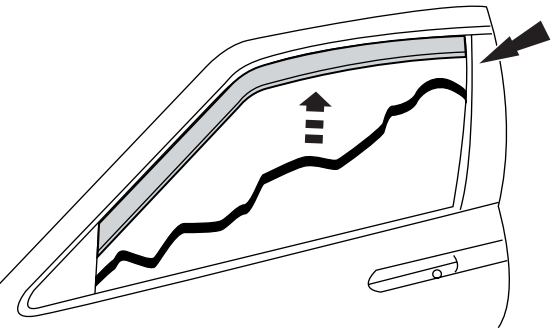

8

Installation Steps 4 Piece Set

NOTE: Actual application may vary slightly from illustrations.

The rear visor installs utilizing the same procedure as above.

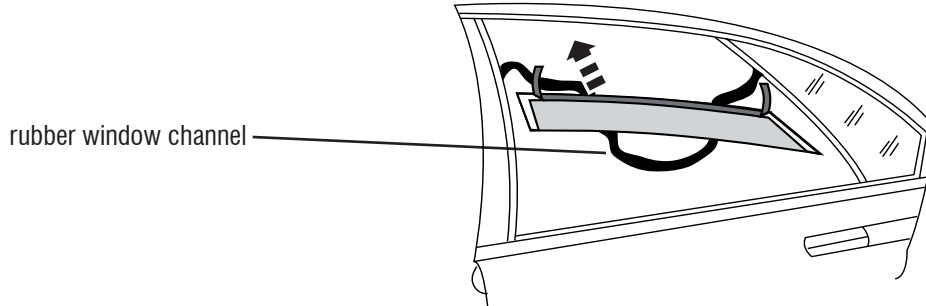

9

Repeat **Steps 1-9** for opposite side.

Care and Cleaning

- Wash only with mild soap & dry with a clean cloth.

Congratulations!

You have purchased one of the many quality Auto Ventshade™ branded products offered by Lund International, Inc. We take the utmost pride in our products and want you to enjoy years of satisfaction from your investment. We have made every effort to ensure that your product is top quality in terms of fit, durability, finish and ease of installation.



AUTO VENTSHADE™

Lund International, Ventshade Accessories Division

655 Raco Drive, Lawrenceville, GA 30045

800-241-7219 • Fax 770-339-5839 • Visit us at lundinternational.com



© 2005 Lund International, Inc. All rights reserved.

Auto Ventshade™, the Auto Ventshade™ logo and the AVS™ logo are trademarks of Lund International, Inc.





Ventvisor® Deflector

Pour obtenir une installation correcte et le meilleur ajustement possible, lire toutes les instructions AVANT de commencer.
 Pour toute assistance technique ou obtention de pièces manquantes, appeler le service des relations avec la clientèle au 1-800-241-7219.

Informations importantes concernant la sécurité



- ATTENTION – Avant de conduire, s'assurer que la visière est solidement assujettie sur le véhicule.
- Ne pas utiliser les stations de lavage de voitures à brosses.
- Ne pas utiliser de solvants.
- Vérifier régulièrement le serrage des composants.

Contenu - Ensemble 2 pièces

NOTE: Le produit réel peut changer de l'illustration.

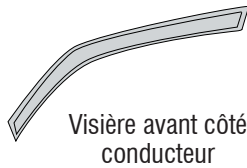

Visière avant côté conducteur

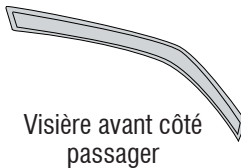

Visière avant côté passager



Tampons à l'alcool (2)

Contenu - Ensemble 4 pièces

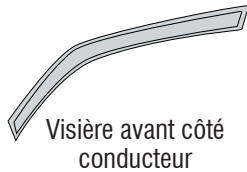

Visière avant côté conducteur

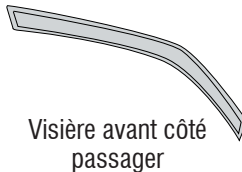

Visière avant côté passager

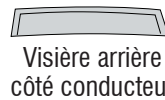

Visière arrière côté conducteur



Visière arrière côté passager



Tampons à l'alcool (4)

Outils nécessaires



Fournitures pour lavage de voiture



Serviette propre

Préparation pour la peinture/l'installation

- Il est recommandé de procéder à un essai pour s'assurer que le positionnement et l'ajustement sont corrects.
- Vérifier l'ajustement des pièces avant peinture, car nous n'acceptons pas le retour de pièces modifiées ou peintes.
- Laver les glissières de glaces de la portière du véhicule pour éliminer toute poussière et tous débris.
- Sécher les glissières avec une serviette propre.

Étapes d'installation

REMARQUE : La méthode d'application peut être légèrement différente de celle représentée par les illustrations.

Abaisser complètement la glace côté conducteur.

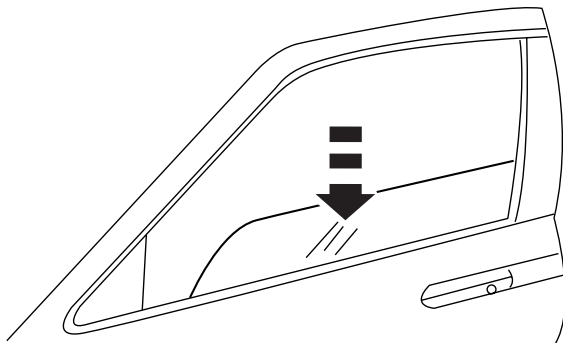

1

Faire sortir la glissière en caoutchouc de la glace jusqu'au point illustré.

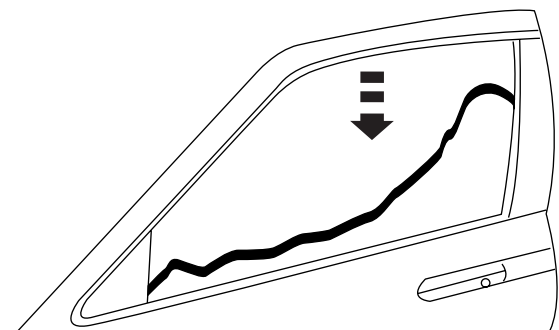

2

Étapes d'installation

REMARQUE : La méthode d'application peut être légèrement différente de celle représentée par les illustrations.



Avec un tampon à l'alcool, nettoyer l'intérieur du cadre métallique et le sécher avec un chiffon doux.

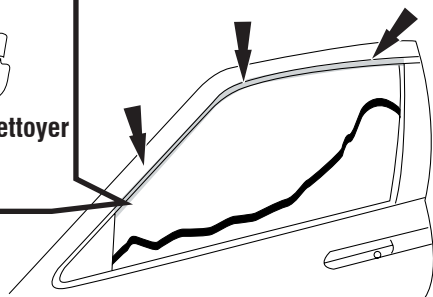
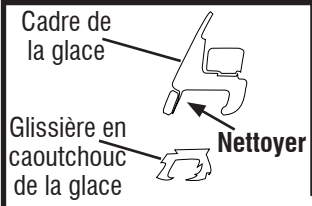

3

Retirer la protection d'adhésif des rebords avant et arrière. Décoller 5 cm (2 po) de protection d'adhésif à chaque extrémité du rebord latéral.

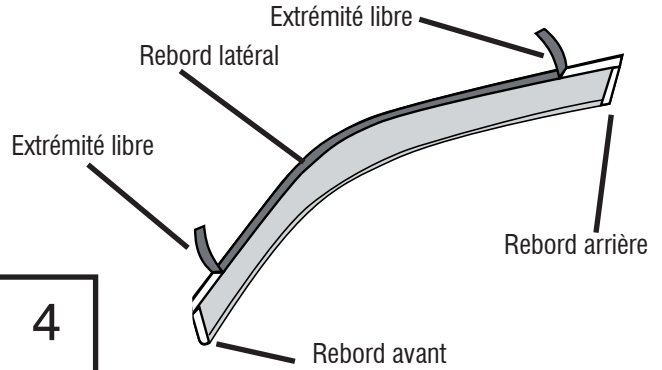

4

Placer le déflecteur dans le cadre de glace, en commençant à l'avant, en le faisant légèrement fléchir pour pouvoir insérer le rebord d'extrémité arrière. S'assurer que les extrémités libres de la protection d'adhésif sont exposées.

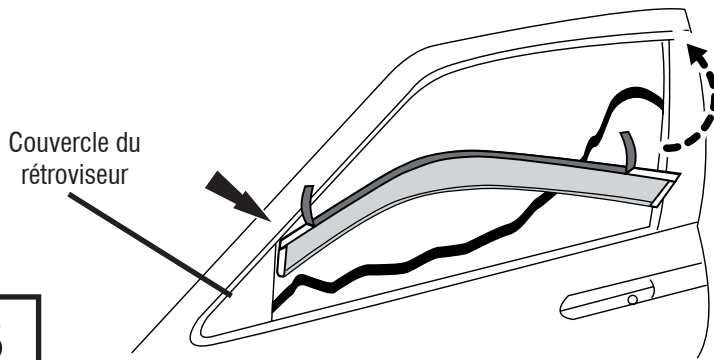

5

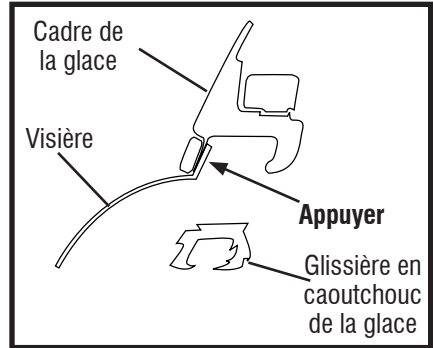

Coupe transversale de la visière en place

Une fois la visière en position finale, retirer le reste de la protection d'adhésif en tirant sur les extrémités libres.

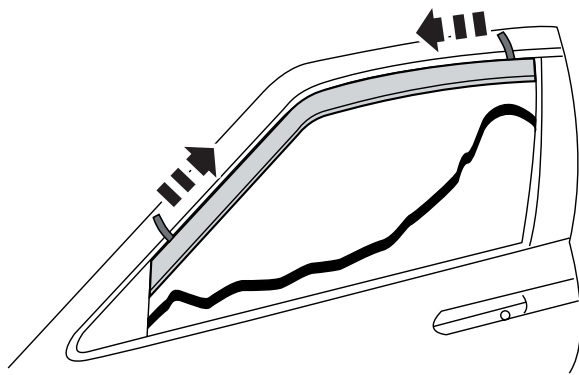

6

Pour assurer la bonne adhésion du ruban adhésif, appuyer tout le long du dos des rebords de la visière.

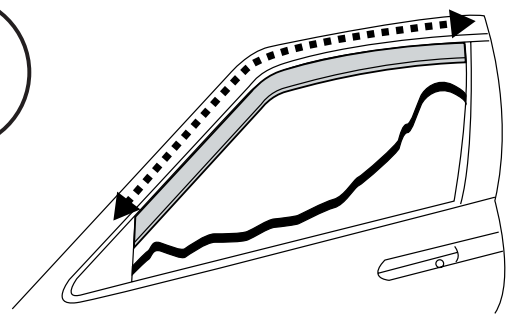

7

Remettre en place la glissière en caoutchouc de la glace, en commençant par le coin supérieur arrière. Le coin supérieur arrière doit être correctement remis en place avant l'installation du restant de la glissière.

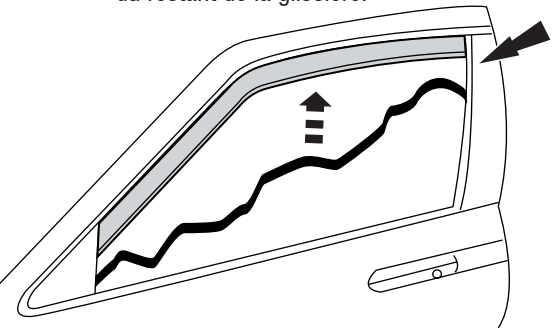

8

Étapes d'installation Ensemble 4 pièces

REMARQUE : La méthode d'application peut être légèrement différente de celle représentée par les illustrations.

La visière arrière doit être mise en place suivant la même procédure que celle décrite ci-dessus.

Glissière en caoutchouc
de la glace

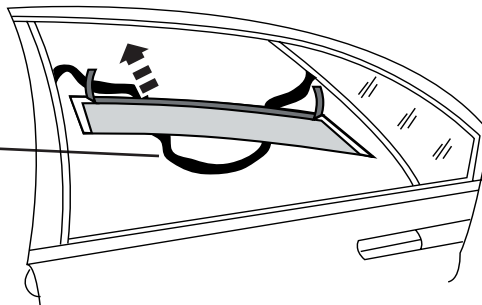

9

Répéter les **étapes 1 à 9** pour le côté opposé.

Entretien et nettoyage

- Laver exclusivement avec de l'eau savonneuse et sécher avec un chiffon propre.

Félicitations !

Vous avez acheté l'un des nombreux produits de qualité Auto Ventshade™ fabriqués par Lund International, Inc. Nous sommes extrêmement fiers de nos produits et souhaitons que vous tiriez des années de satisfaction de votre investissement. Nous avons pris toutes les mesures nécessaires pour assurer que ce produit est d'une qualité supérieure en ce qui concerne l'ajustement, la durabilité, la finition et la facilité d'installation.



AUTO VENTSHADE™

Lund International, Ventshade Accessories Division

655 Raco Drive, Lawrenceville, GA 30045, USA

800-241-7219 • Fax 770-339-5839 • Visitez notre site lundinternational.com



© 2005 Lund International, Inc. Tous droits réservés.
Auto Ventshade™, le logo Auto Ventshade™ et le logo AVS™ sont des marques déposées de Lund International, Inc.





Ventvisor® Deflector

Para una instalación adecuada y el mejor ajuste posible, lea todas las instrucciones ANTES de comenzar. Si desea recibir asistencia técnica u obtener piezas faltantes, llame al Servicio al cliente al 1-800-241-7219.

Información importante de seguridad



- PRECAUCIÓN - Antes de conducir, asegúrese de que la visera esté correctamente anclada al vehículo.
- No utilice servicios automáticos de limpieza de vehículos que utilizan cepillos.
- No utilice limpiadores al solvente de ningún tipo.
- Compruebe periódicamente que todos los componentes estén ajustados.

Contenido - Juego de dos piezas

NOTA: El producto real puede variar de la ilustración.

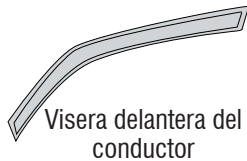

Paños esterilizados x 2

Contenido - Juego de cuatro piezas

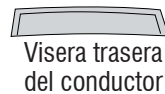
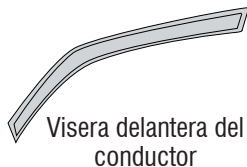

Paños esterilizados x 4

Herramientas necesarias



Equipo de limpieza de vehículos



Toalla limpia

Preparación antes de pintar o instalar

- Se recomienda realizar un ajuste de prueba para asegurar el posicionamiento y ajuste correctos.
- Compruebe que las piezas se ajusten correctamente antes de pintarlas, ya que no aceptaremos la devolución de piezas modificadas o pintadas.
- Lave los canales de la ventanilla del vehículo para quitar los desechos y la suciedad.
- Seque los canales de la ventanilla con una toalla limpia.

Pasos de instalación

AVISO: La colocación real puede variar con respecto a las ilustraciones.

Baje completamente la ventanilla del conductor.

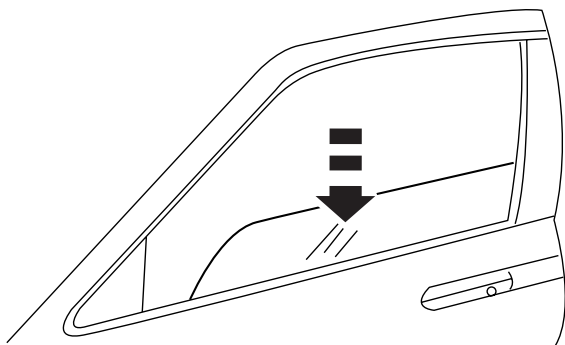

1

Quite el canal de goma de la ventanilla hasta donde se indica.

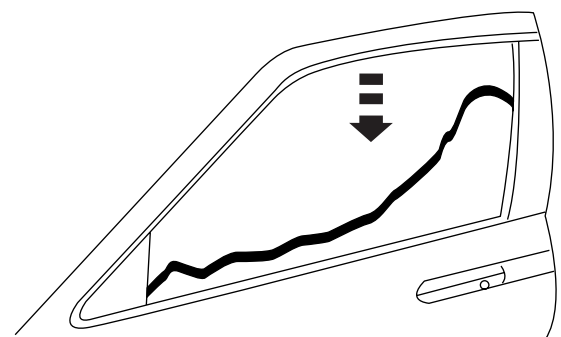

2

Pasos de instalación

AVISO: La colocación real puede variar con respecto a las ilustraciones.



Limpie el **interior** del marco de metal con un paño esterilizado y séquelo con un paño suave.

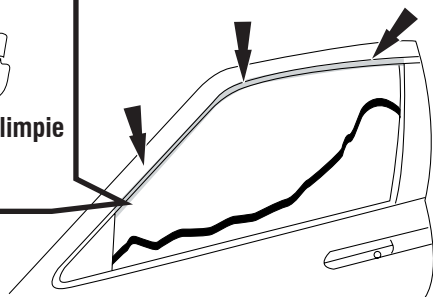
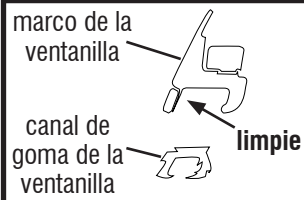

3

Quite la cinta protectora de los rebordes frontal y trasero. Retire 2" (5 cm) de cinta protectora de cada uno de los extremos del reborde lateral.

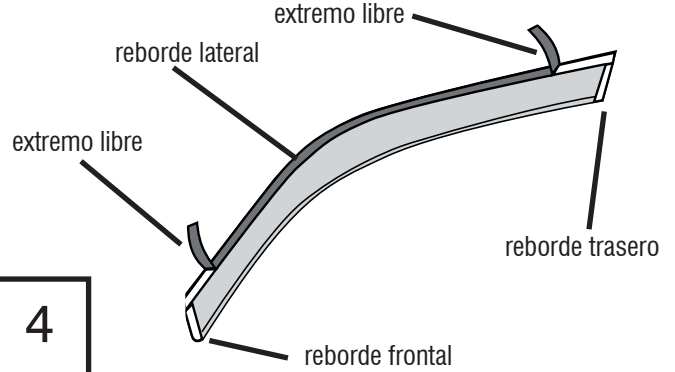

4

Coloque el deflector en el marco de la ventanilla, comenzando por la parte frontal, doblándola levemente para insertar el extremo del reborde trasero. Asegúrese de que se pueda acceder fácilmente a los extremos libres de la cinta protectora.

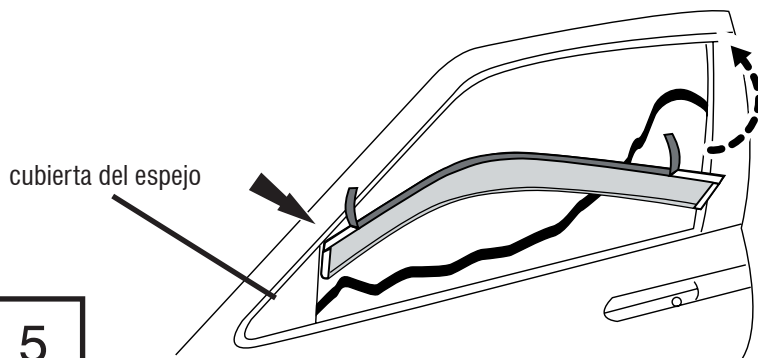

5

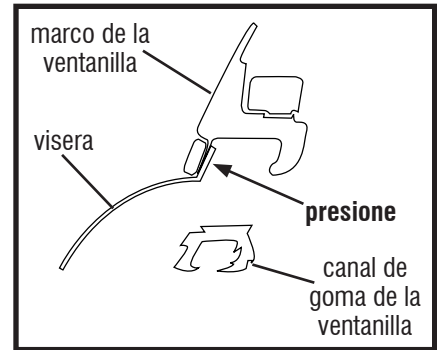

vista del corte transversal de la visera ubicada en su lugar

Una vez que la visera se encuentre en su posición definitiva, quite la cinta protectora restante tirando de los extremos libres.

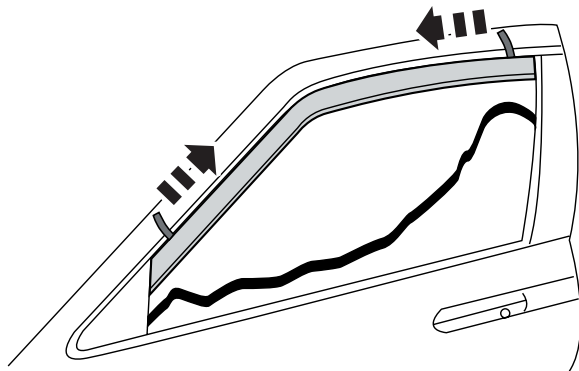

6

Para asegurarse de que la cinta se adhiera completamente presione sobre la parte trasera de los rebordes de la visera.

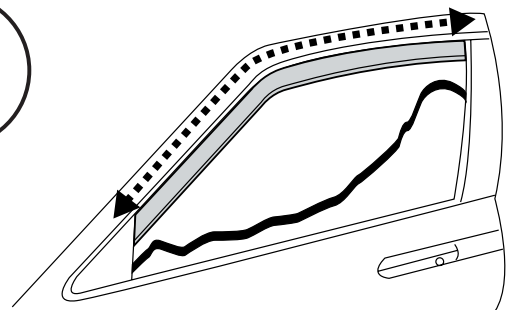

7

Vuelva a colocar el canal de goma de la ventanilla, comenzando en la esquina trasera superior. La esquina trasera superior debe estar colocada nuevamente y de manera correcta antes de instalar el canal restante.

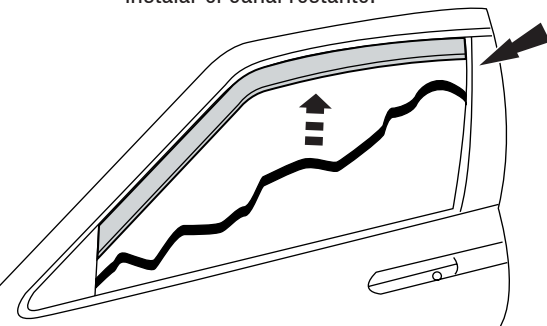

8

Pasos de instalación

AVISO: La colocación real puede variar con respecto a las ilustraciones.

Juego de cuatro piezas

La visera trasera se instala siguiendo el procedimiento anterior.

canal de goma de la ventanilla

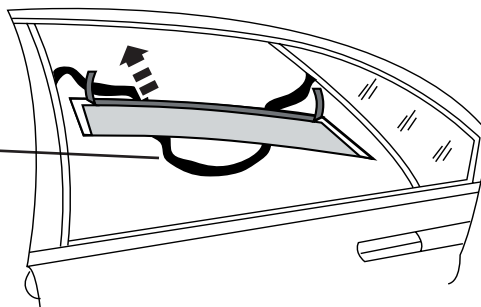

9

Repita los **pasos 1 al 9** para el otro lado del vehículo.

Cuidado y limpieza

- Limpie solamente con agua jabonosa tibia y seque con un paño limpio.

Felicidades

Usted ha comprado uno de los tantos artículos de calidad de Auto Ventshade™ ofrecidos por Lund International, Inc. Nuestros productos son nuestro mayor orgullo. Deseamos que disfrute de años de satisfacción con su inversión. Hemos realizado todos los esfuerzos para asegurarnos de que su producto sea de la mejor calidad en cuanto a ajuste, durabilidad, acabado y facilidad de instalación.



AUTO VENTSHADE™

Lund International, Ventshade Accessories Division

655 Raco Drive, Lawrenceville, GA 30045

800-241-7219 • Fax 770-339-5839 • Visite nuestro sitio Web: lundinternational.com



© 2005 Lund International, Inc. Todos los derechos reservados.
Auto Ventshade™, el logo de Auto Ventshade™ y el logo de AVS™ son marcas comerciales de Lund International, Inc.

