

Installation Instructions

I - Sheet Number VV77 Rev.A



AUTO VENT SHADE™

Ventvisor® Deflector

For proper installation and best possible fit, please read all instructions BEFORE you begin.
For technical assistance or to obtain missing parts, please call Customer Relations at 1-800-241-7219.

Important Safety Information



- CAUTION - Before driving, ensure that the vent visor is properly secured to vehicle.
- Do not use automatic "brush-style" car washes.
- Do not use cleaning solvents of any kind.
- Periodically check all components for tightness.

Contents - 2 Piece Set **NOTE:** Actual product may vary from illustration.

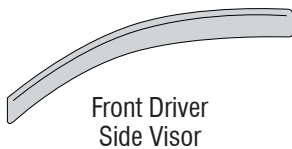

Front Driver Side Visor

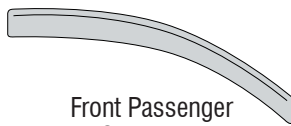

Front Passenger Side Visor



Alcohol Pad x2

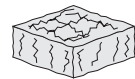

Scotch brite pad

Contents - 4 Piece Set

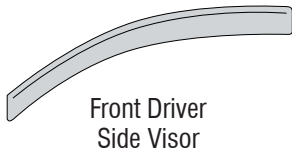

Front Driver Side Visor

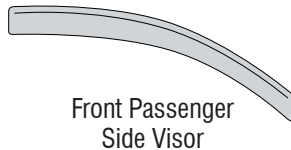

Front Passenger Side Visor



Rear Driver Side Visor



Rear Passenger Side Visor



Alcohol Pad x4



Scotch brite pad

Tools Required



Car Wash Supplies



Clean Towel

Preparation Before Painting / Installation

- A trial fit is recommended to ensure proper positioning and fit.
- Check fit of parts before painting as we will not accept the return of modified or painted parts.
- Wash and dry your vehicle to remove any debris and/or dirt from the installation area.

Installation Steps **NOTE:** Actual application may vary slightly from illustrations.

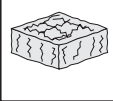

Clean the mounting location with an alcohol pad.
NOTE: If trim is rubber, scuff with scotch brite pad before cleaning with alcohol pad.

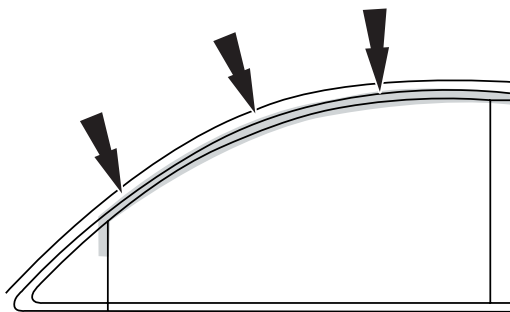

1

NOTE: visors mount on the outside of the door frame.

Remove tape liner from front & rear flanges. Peel back 2" (5 cm) of tape liner from each end of top flange.

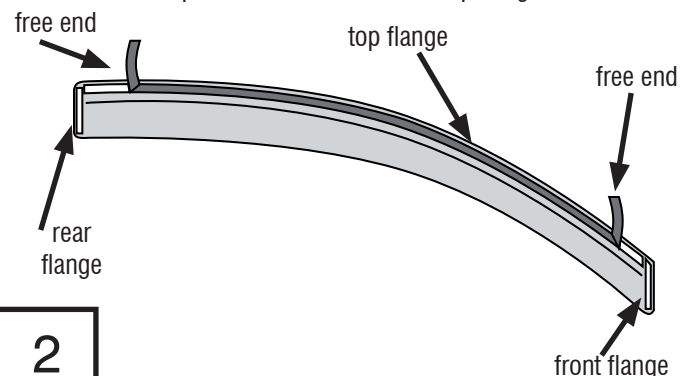

2

Installation Steps

NOTE: Actual application may vary slightly from illustrations.

Align the driver side visor with the previously cleaned surface.

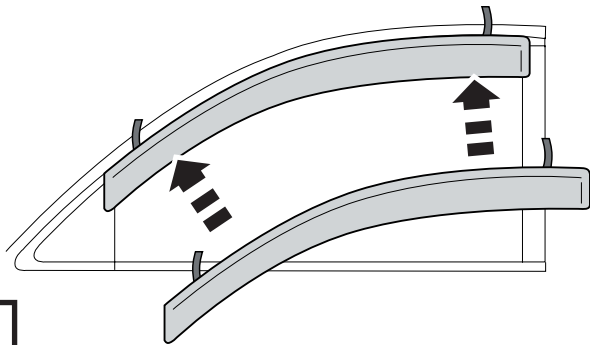

3

Press the exposed area of tape against the surface and verify position.

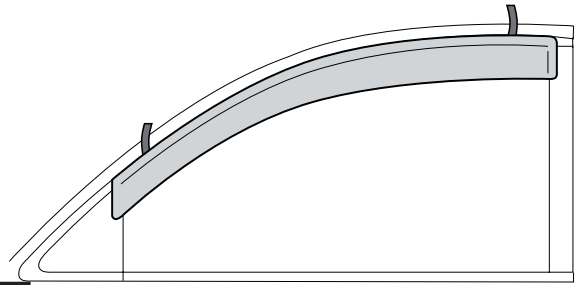

4

With the visor in its final position, remove the remaining tape liner by pulling on free ends.

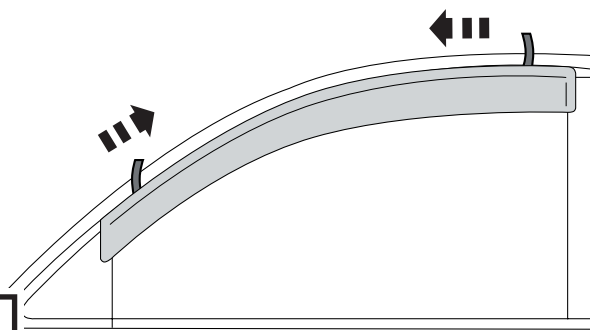

5

Press along visor flanges to ensure proper adhesion.

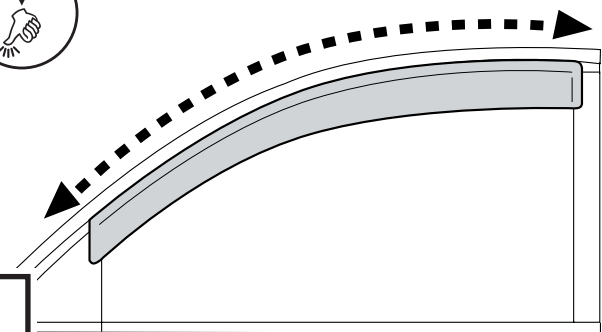

6

4 Piece Set

The rear visor attaches with same preparation methods as the front visor.

rear visor in final position

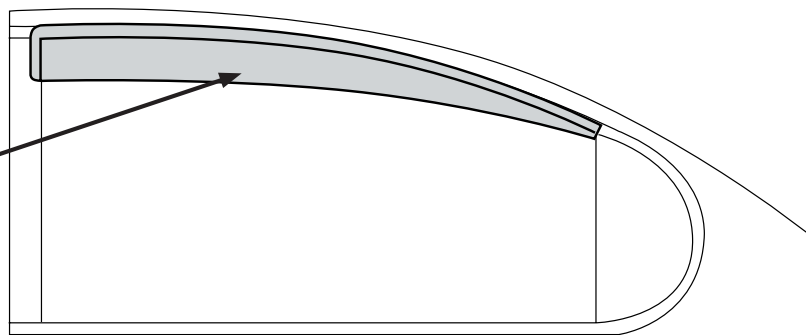

7

Repeat **Steps 1 thru 7** for the passenger side.

Care and Cleaning

- Wash only with mild soap & dry with a clean cloth.

Congratulations!

You have purchased one of the many quality Auto Ventshade™ branded products offered by Lund International, Inc. We take the utmost pride in our products and want you to enjoy years of satisfaction from your investment. We have made every effort to ensure that your product is top quality in terms of fit, durability, finish and ease of installation.



AUTO VENTSHADE™

Lund International, Ventshade Accessories Division

655 Raco Drive, Lawrenceville, GA 30045

800-241-7219 • Fax 770-339-5839 • Visit us at lundinternational.com

© 2005 Lund International, Inc. All rights reserved.

Auto Ventshade™, the Auto Ventshade™ logo and the AVS™ logo are trademarks of Lund International, Inc.





Ventvisor® Deflector

Pour obtenir une installation correcte et le meilleur ajustement possible, lire toutes les instructions AVANT de commencer.
 Pour toute assistance technique ou obtention de pièces manquantes, appeler le service des relations avec la clientèle au 1-800-241-7219.

Informations importantes concernant la sécurité



- ATTENTION – Avant de conduire, s'assurer que la visière est solidement assujettie sur le véhicule.
- Ne pas utiliser les stations de lavage de voitures à brosses.
- Ne pas utiliser de solvants.
- Vérifier régulièrement le serrage des composants.

Contenu - Ensemble 2 pièces

NOTE: Le produit réel peut changer de l'illustration.



Visière avant côté conducteur

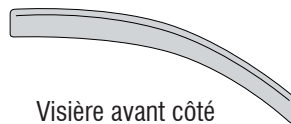

Visière avant côté passager



Tampons à l'alcool (2)

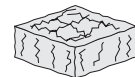

tampon à récurer Scotch Brite

Contenu - Ensemble 4 pièces

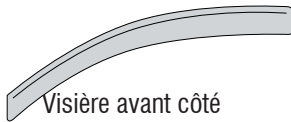

Visière avant côté conducteur

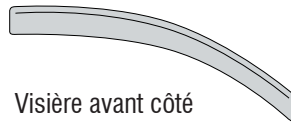

Visière avant côté passager

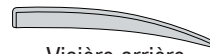

Visière arrière côté conducteur



Visière arrière côté passager



Tampons à l'alcool (4)



tampon à récurer Scotch Brite

Outils nécessaires



Fournitures pour lavage de voiture



Serviette propre

Préparation pour la peinture/l'installation

- Il est recommandé de procéder à un essai pour s'assurer que le positionnement et l'ajustement sont corrects.
- Vérifier l'ajustement des pièces avant peinture, car nous n'acceptons pas le retour de pièces modifiées ou peintes.
- Laver les glissières de glaces de la portière du véhicule pour éliminer toute poussière et tous débris.
- Sécher les glissières avec une serviette propre.

Étapes d'installation

REMARQUE : La méthode d'application peut être légèrement différente de celle représentée par les illustrations.

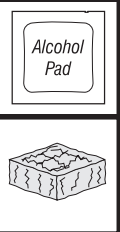

Nettoyez la surface de montage avec un tampon à l'alcool. **NOTE:** Si l'équilibre est en caoutchouc, usure avec un tampon à récurer Scotch Brite avant le nettoyage avec la garniture d'alcool.



REMARQUE : Les visières se montent à l'extérieur de l'encadrement de portière.

1

Retirez la protection d'adhésif des rebords avant et arrière. Décollez environ 5 cm (2 po) de protection d'adhésif à chaque extrémité du rebord supérieur.

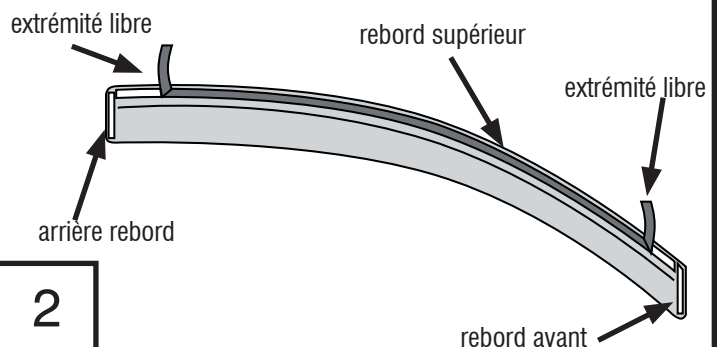

2

Étapes d'installation

REMARQUE : La méthode d'application peut être légèrement différente de celle représentée par les illustrations.

Alignez la visière du côté conducteur avec la surface nettoyée antérieurement.

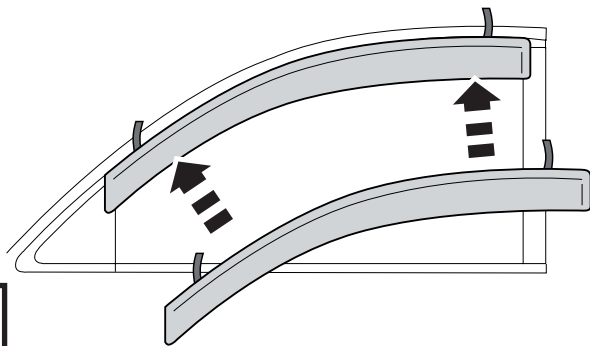

3

Poussez la région exposée de l'adhésif contre la surface et vérifiez-en la position.

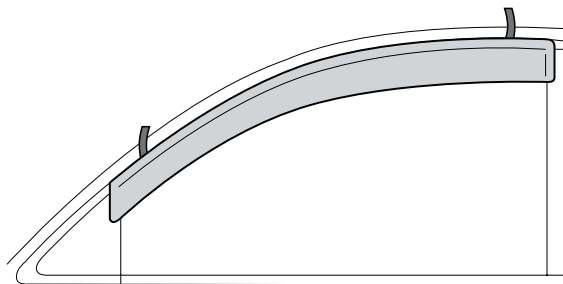

4

La visière se trouvant en position finale, retirez la protection d'adhésif en tirant sur les extrémités libres.

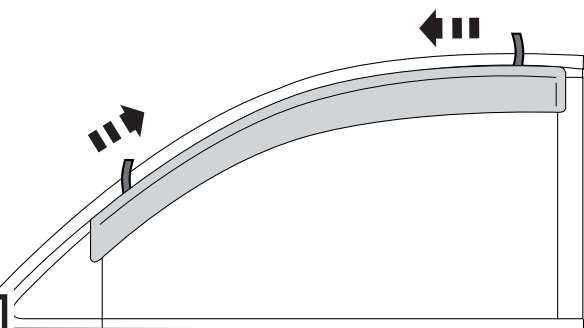

5

Appuyez le long des rebords de la visière pour produire une bonne adhésion.

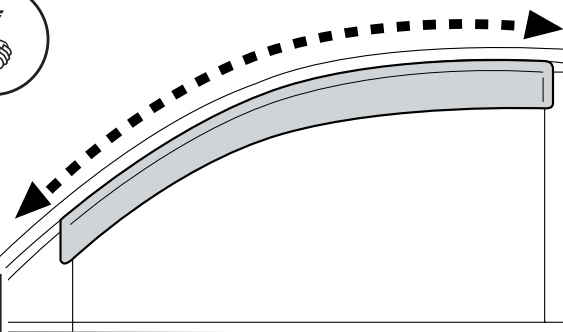

6

Ensemble 4 pièces

L'installation de la visière arrière demande la même préparation que celle de la visière avant.

visière arrière en position finale

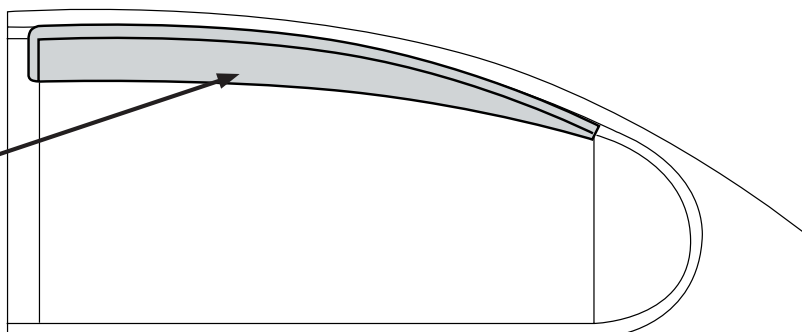

7

Recommencer les étapes 1 à 7 du côté du passager.

Entretien et nettoyage

- Laver exclusivement avec de l'eau savonneuse et sécher avec un chiffon propre.

Félicitations !

Vous avez acheté l'un des nombreux produits de qualité Auto Ventshade™ fabriqués par Lund International, Inc. Nous sommes extrêmement fiers de nos produits et souhaitons que vous tiriez des années de satisfaction de votre investissement. Nous avons pris toutes les mesures nécessaires pour assurer que ce produit est d'une qualité supérieure en ce qui concerne l'ajustement, la durabilité, la finition et la facilité d'installation.



AUTO VENTSHADE™

Lund International, Ventshade Accessories Division
655 Raco Drive, Lawrenceville, GA 30045, USA

800-241-7219 • Fax 770-339-5839 • Visitez notre site lundinternational.com

© 2005 Lund International, Inc. Tous droits réservés.

Auto Ventshade™, le logo Auto Ventshade™ et le logo AVS™ sont des marques déposées de Lund International, Inc.





Ventvisor® Deflector

Para una instalación adecuada y el mejor ajuste posible, lea todas las instrucciones ANTES de comenzar. Si desea recibir asistencia técnica u obtener piezas faltantes, llame al Servicio al cliente al 1-800-241-7219.

Información importante de seguridad



- PRECAUCIÓN - Antes de conducir, asegúrese de que la visera esté correctamente anclada al vehículo.
- No utilice servicios automáticos de limpieza de vehículos que utilizan cepillos.
- No utilice limpiadores al solvente de ningún tipo.
- Compruebe periódicamente que todos los componentes estén ajustados.

Contenido - Juego de dos piezas

NOTA: El producto real puede variar de la ilustración.



Visera delantera del conductor



Visera delantera del acompañante



Paños esterilizados x 2



el paño Scotch Brite

Contenido - Juego de cuatro piezas



Visera delantera del conductor



Visera delantera del acompañante



Visera trasera del conductor



Visera trasera del acompañante



Paños esterilizados x 4

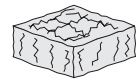

el paño Scotch Brite

Herramientas necesarias



Equipo de limpieza de vehículos



Toalla limpia

Preparación antes de pintar o instalar

- Se recomienda realizar un ajuste de prueba para asegurar el posicionamiento y ajuste correctos.
- Compruebe que las piezas se ajusten correctamente antes de pintarlas, ya que no aceptaremos la devolución de piezas modificadas o pintadas.
- Lave los canales de la ventanilla del vehículo para quitar los desechos y la suciedad.
- Seque los canales de la ventanilla con una toalla limpia.

Pasos de instalación

AVISO: La colocación real puede variar con respecto a las ilustraciones.

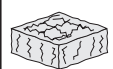

Limpie el lugar de colocación con un paño esterilizado.

NOTA: Si el ajuste es de goma, desgaste con el paño Scotch Brite antes de limpiar con el cojín del alcohol.



AVISO: las viseras se colocan en la parte exterior del marco de la puerta.

1

Quite la cinta protectora de los rebordes frontales y traseros. Retire 2 pulgs. (5 cm) de cinta protectora de cada uno de los extremos del reborde superior.

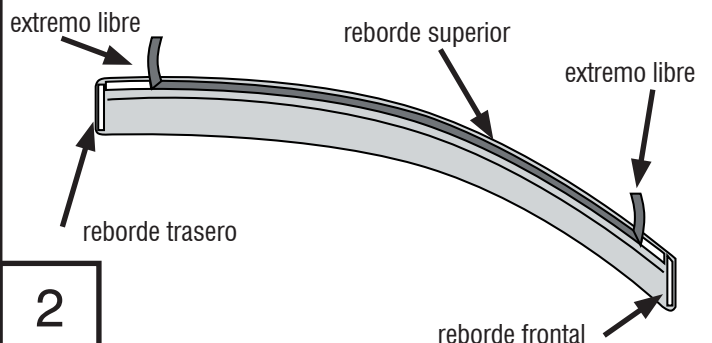

2

Pasos de instalación

AVISO: La colocación real puede variar con respecto a las ilustraciones.

Alinee la visera del conductor con la superficie que limpió anteriormente.

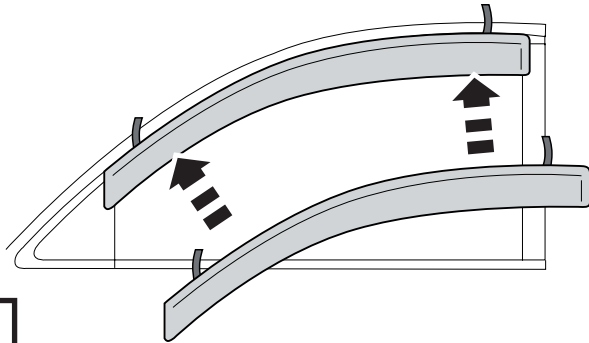

3

Presione la cinta expuesta sobre la superficie y verifique la posición.

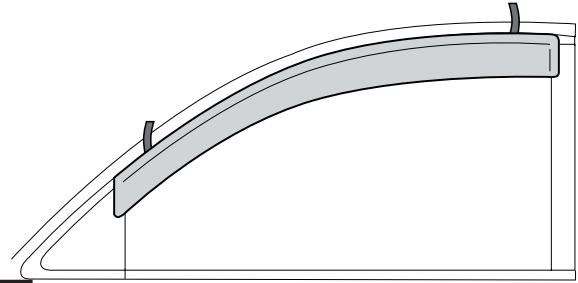

4

Una vez que la visera se encuentra en su posición definitiva, quite la cinta protectora restante tirando de los extremos libres.

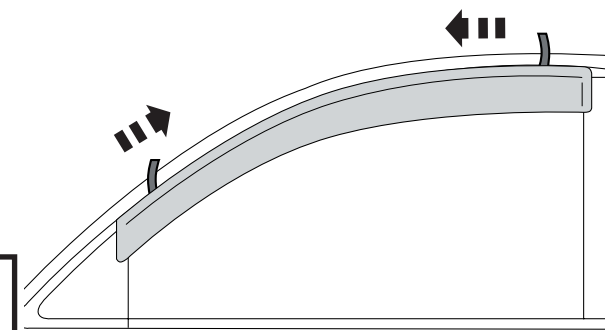

5

Presione sobre los rebordes de la visera para asegurarse de que se adhieran correctamente.

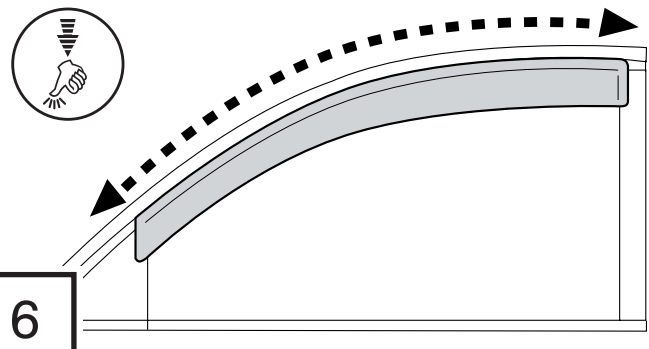

6

Juego de cuatro piezas

La visera trasera se coloca siguiendo los mismos pasos que se siguen para la visera delantera.

visera trasera en posición definitiva

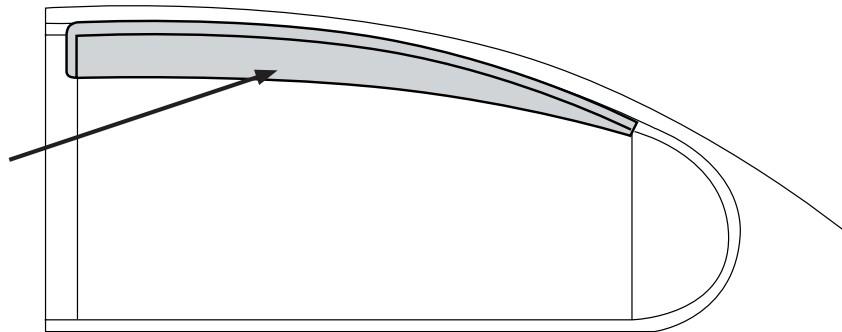

7

Repita los pasos 1 a 7 para el lado del acompañante.

Cuidado y limpieza

- Limpie solamente con agua jabonosa tibia y seque con un paño limpio.

Felicidades

Usted ha comprado uno de los tantos artículos de calidad de Auto Ventshade™ ofrecidos por Lund International, Inc. Nuestros productos son nuestro mayor orgullo. Deseamos que disfrute de años de satisfacción con su inversión. Hemos realizado todos los esfuerzos para asegurarnos de que su producto sea de la mejor calidad en cuanto a ajuste, durabilidad, acabado y facilidad de instalación.



Lund International, Ventshade Accessories Division
655 Raco Drive, Lawrenceville, GA 30045

800-241-7219 • Fax 770-339-5839 • Visite nuestro sitio Web: lundinternational.com

© 2005 Lund International, Inc. Todos los derechos reservados.



Auto Ventshade™, el logo de Auto Ventshade™ y el logo de AVS™ son marcas comerciales de Lund International, Inc.

