



**2022 Jeep Wagoneer
Mud Flap Set, Front
Mounting Diagram & Instructions
Kit# GCR64F
Will not fit Grand Wagoneer**

IMPORTANT:

Manufacturer is not responsible for negligent use of vehicle with mud flaps installed, including over-tightening of screws and bolts causing damage to vehicle or mud flaps.



TOOLS REQUIRED-

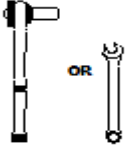

1/4" Open Wrench or
Socket Wrench

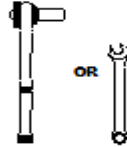

7/16" Open Wrench or
Socket Wrench

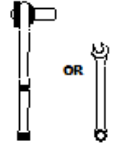

3/8" Open Wrench or
Socket Wrench

FLAPS

(1) Flap Assembly,
Front, DS

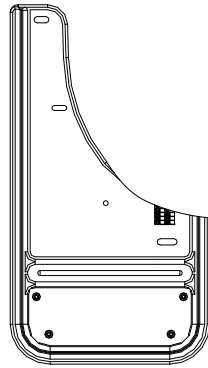

(1) Flap Assembly
Front, PS

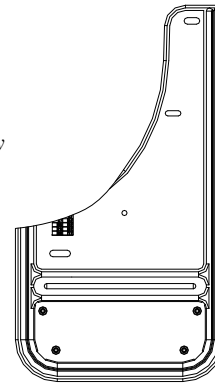

PARTS BAG # 770668

a) (2) Screw, Tek
1/4"-14 x 1.25" SS Blk Ox.
Part #010050



b) (4) Capscrew, SS
1/4"-20 x 3/8" Blk Ox
Part # 014069



c) (2) Screw, Sheet Metal
#8-18 x 1.25" Blk Oxid.
Part #016061



d) (2) Washer, Flat
0.281" x 1" SS, Blk Ox.
Part #018069

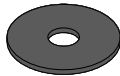

e) (2) Washer, Flat
0.203" x 1" SS, Blk Ox.
Part #018070

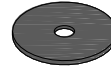

f) (4) Washer, Flat
0.281" x 1.5", SS Blk Oxid.
Part #018087



g) (2) Spring Nut
1/4"-20UNC, 0.54"
Part #028010



h) (2) Spring Nut
1/4"-20UNC, 27/32"
Part #028011



j) (1) Protective Tape
2 pc. Kit
Part # 770681

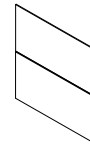

INSTALLATION (For ease of installation it is suggested that the wheel be removed)

1. Before you install your Mud Flap Set, see the diagram and parts list for all necessary parts. Start on the driver's side.
2. Remove factory screw from factory hole #5.
3. Loosely secure mudflap hole #2 to factory hole #5 using a sheet metal screw (c) and flat washer (e)

4. Hold rubber aligned with fender and mark the location of spring nut (g) through mud flap hole #1 and spring nut (h) through mud flap hole #4
5. Install spring nut (g) over durastrip (j) and spring nut (h) over mark made through mudflap hole #4.
6. Gently pull rubber away and install one piece of protective tape (i) over mark made through mud flap hole #1
7. Loosely secure mud flap hole #1 to spring nut (g) using a capscrew (b) and flat washer (d)
8. Loosely secure mud flap hole #4 to spring nut (h) using a capscrew (b) and flat washer (f)
9. Square the flap using a square or other leveling tool.
10. Tighten all fasteners.
11. Install mud flap hole #3 to factory plastic liner using a tek screw (a) and flat washer (e)
12. Repeat procedure for passenger side.

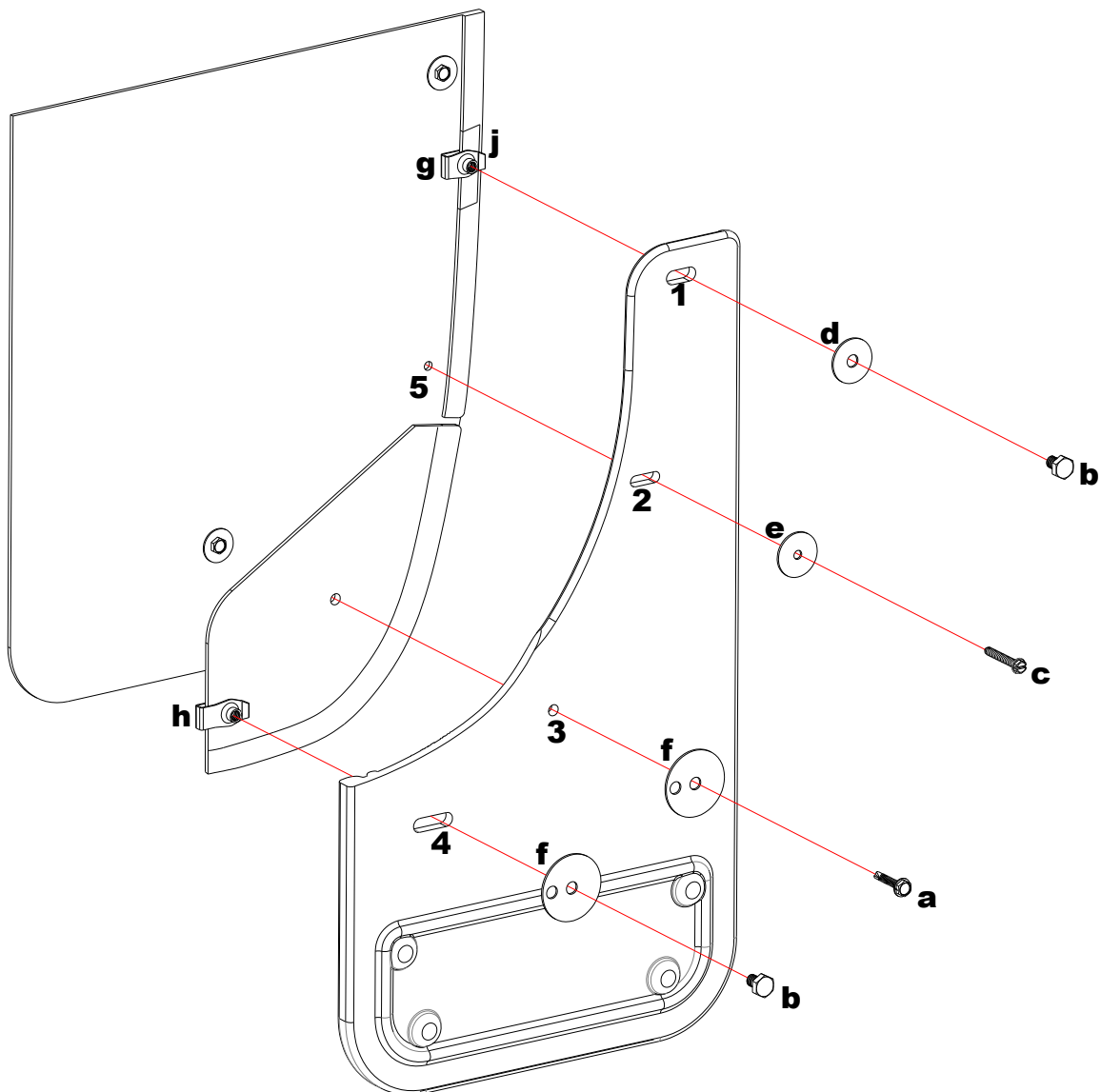

Please check out our YouTube channel to see an install video for this application.





GATORBACK MUDFLAPS

2022 Jeep Wagoneer & Grand Wagoneer Mud Flap Set, Rear Mounting Diagram & Instructions Kit# GCR64R

IMPORTANT:

Manufacturer is not responsible for negligent use of vehicle with mud flaps installed, including over-tightening of screws and bolts causing damage to vehicle or mud flaps.



TOOLS REQUIRED-

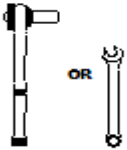

1/4" Open Wrench or
Socket Wrench

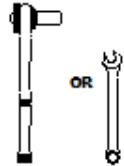

7/16" Open Wrench or
Socket Wrench

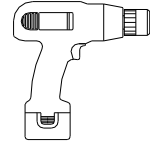

Electric or Rechargeable
Drill



1/4" Drill
Bit

FLAPS

(1) Flap Assembly,
Rear, DS

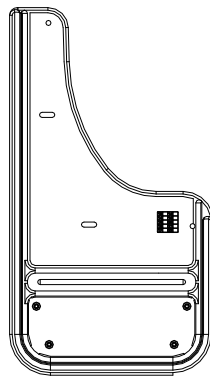

(1) Flap Assembly
Rear, PS

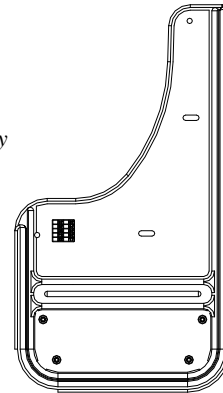

PARTS BAG # 770669

a) (2) Capscrew
#10-24 x 1.5" SS Blk Ox.
Part #012027

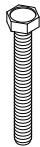

b) (6) Screw, Sheet Metal
#8-18 x 1.5" SS Blk Ox.
Part # 016063



c) (10) Washer, Spacer
5/16" x 1" x 1/4"
Part #018036

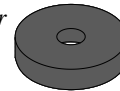

d) (4) Washer, Flat
0.203" x 1" SS, Blk Ox.
Part #018070

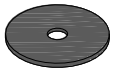

e) (6) Washer, Flat
0.203" x 1.5" SS, Blk Ox.
Part #018080

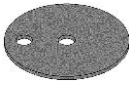

f) (2) Washer, Lock
1/4" Helical SS, Blk Ox.
Part #024001



g) (2) Nut, Hex
1/4"-20 SS, Blk Ox.
Part #025003



INSTALLATION (For ease of installation it is suggested that the wheel be removed)

2. Before you install your Mud Flap Set, see the diagram and parts list for all necessary parts. Start on the driver's side.
2. Remove 3 factory screws from fender.
3. Loosely secure mudflap hole #3 through two spacer washers (c) to factory hole #7 using a sheet metal screw (b) and flat washer (e).

4. Loosely secure mud flap hole #2 through two spacer washers (c) to factory hole #6 using a sheet metal screw (b) and a flat washer (e).
5. Loosely secure mud flap hole #1 through one spacer washer (c) to factory hole #5 using a sheet metal screw (b) and a flat washer (e).
6. Hold mudflap against the liner and drill a 1/4" hole through mudflap hole #4 into factory plastic liner.
7. Loosely install mud flap hole #4 to hole made in factory liner using a capscrew (a) flat washer (d), and secure using a flat washer (d), lock washer (f), and hex nut (g)
8. Square the flap using a square or other leveling tool.
9. Tighten all fasteners.
10. Repeat procedure for passenger side.

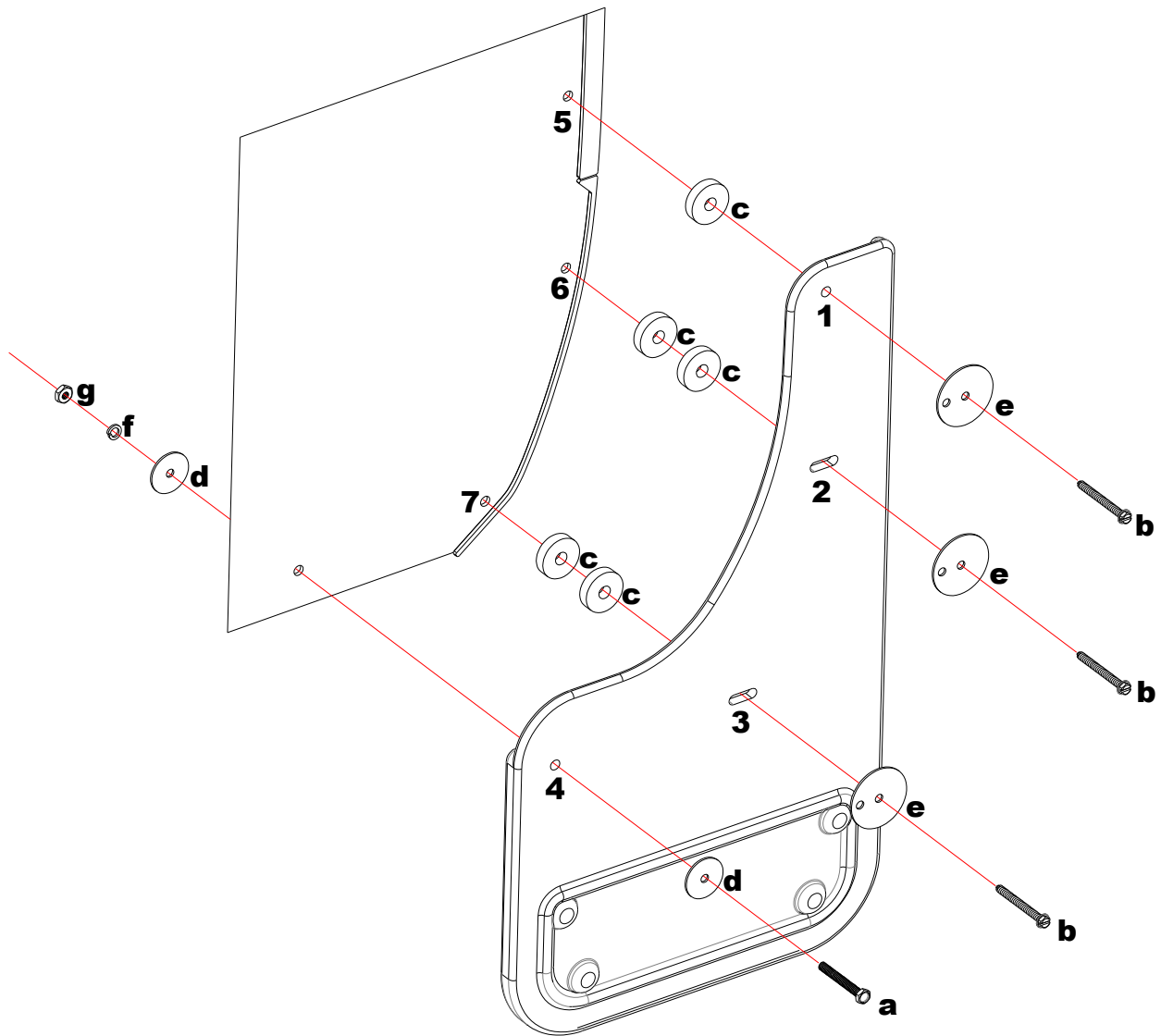

Please check out our YouTube channel to see an install video for this application.

